



Parker Legris Rectus Distribution Catalogue

Low Pressure Fluid Handling Solutions



ENGINEERING YOUR SUCCESS.

Welcome to the world of Parker Legris & Rectus

We are very proud to present our new catalogue. In this edition, you will find our range of low pressure connections: fittings, couplers, tubing, blowguns and valves. In addition to outstanding products, this catalogue provides all the information you need to assist and advise your customers.

Within the world of Parker products, the focus here is on two of our brands - Legris and Rectus - which are both guarantees of quality.

This catalogue is also available online in interactive digital format. Please visit our website via the QR code below.

Find this user guide in the digital version on all your screens by scanning this QR code or on www.parkerlegris.com or on www.parker.com/LPCE

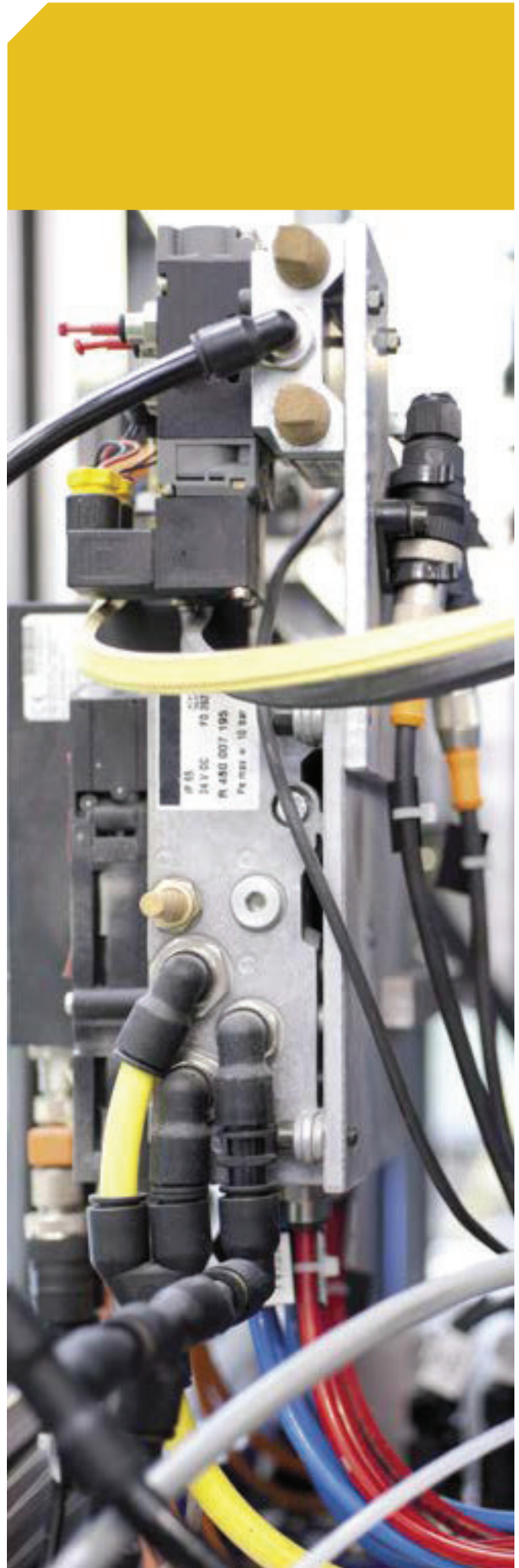

Parker Low Pressure Connectors Europe

Provider of Fluid Handling Solutions for Industrial Automation & Processing

For over 60 years, we have been designing, manufacturing and customising safe and reliable quick connection solutions, for distribution across the globe.

THIS IS

 <p>6 Operating Groups</p> <ul style="list-style-type: none"> • Aerospace • Engineered Materials • Filtration • Fluid Connections • Instrumentation • Motion Systems 	 <p>100 Divisions</p>	 <p>Serving Customers in 50 Countries</p>
 <p>\$14 Billion in Global Revenue</p>	 <p>56 690 Empowered Employees</p>	 <p>13 000 Distributors accessing 1 000 Markets</p>

THIS IS &

 <p>850 Employees</p>	 <p>7 Locations in Europe</p>
 <p>ISO 9001 IATF 16949 certified</p>	 <p>4 500 Shipments a day</p>

OUR VALUES

Inventor of push-to-connect technology and market leader of quick connect coupling solutions, Parker Legris Rectus is very proud of its heritage of **60 years of innovation** and stays true to its value of high quality products, supported by manufacturing excellence, in order to ensure that customers needs remain its priority.

- + EXPERTISE:**
passionate people and engaged leadership
- + EXCELLENCE:**
winning culture
- + CUSTOMER EXPERIENCE:**
valued customers

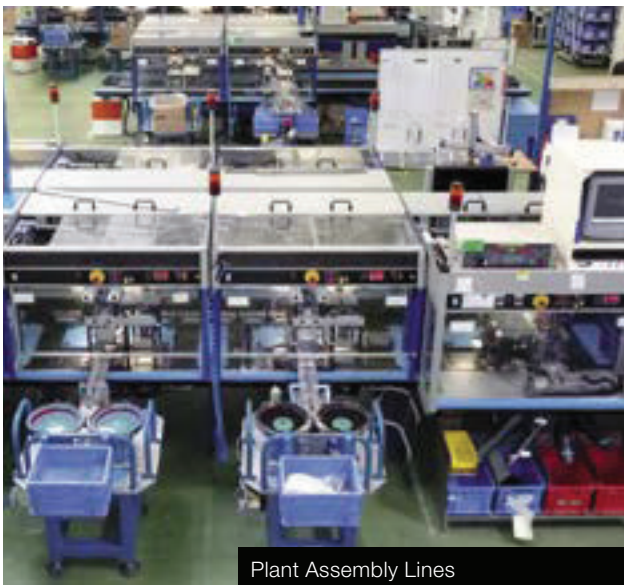

Plant Assembly Lines



OUR DIFFERENTIATORS

- + A GLOBAL PRESENCE**
- + CUSTOMER ENGINEERING SUPPORT**
- + IN-HOUSE ENGINEERING AND MANUFACTURING**

OUR QUALITY MANAGEMENT

- + IATF 16949, ISO 9001 AND ISO 14001 CERTIFIED**

OUR BRANDS



The DNA of Legris & Rectus

Customer Support

Partners in your projects, we offer you support and guidance to surpass technological challenges in order to develop fully adapted customer solutions

Premium Customer Service

As a global player, we provide premium customer service to any of your locations across the globe

Engineering Expertise

We place more than 60 years of expertise in optimizing flow, sealing and gripping technology at your fingertips

Manufacturing Excellence

Our outstanding manufacturing process in injection, brass stamping and automatic assembly, ensures the most competitive products

Quality Management & Traceability

ISO certified, quality management is at the very heart of all our processes throughout the value chain



Test bench for flow rate measures



Engineering Simulation



Thermal enclosure for ageing test



Parker LPCE headquarters

Fields of Applications

Assembly Lines

EXPECTED PERFORMANCE:

- Frequent connection/disconnection
- Safe use
- Compactness
- High flow
- Lightweight

SUITABLE PARKER LEGRIS AND RECTUS RANGES:

- LF 3000® push-in fittings, flow regulators
- Couplers: KP series, 1600 KE, 1700 KE, C 9000
- PA recoil tubing, braided PU recoil hose
- Blowguns



MRO (Maintenance, Repair & Operations)

EXPECTED PERFORMANCE:

- Worldwide availability of products
- Product identification
- Reliability

SUITABLE PARKER LEGRIS AND RECTUS RANGES:

- All ranges of push-in fittings
- Function Fittings
- All series of safety couplers or pneumatic couplers
- Tubing & hoses
- Blowguns



Industrial Automation

EXPECTED PERFORMANCE:

- Vacuum performance
- Mechanical resistance
- Welding spark resistance

SUITABLE PARKER LEGRIS AND RECTUS RANGES:

- LF 3000®, LF 3600 push-in fittings
- Function fittings
- Metal couplers series 21, 25, 26
- PA, PU tubing
- Axial valves, ball valves



Fields of Applications

Beverage

EXPECTED PERFORMANCE:

- High temperature resistance
- FDA, NSF, KTW... compliance
- Compactness
- Easy-to-clean
- Excellent chemical and mechanical resistance

SUITABLE PARKER LEGRIS AND RECTUS RANGES:

- LIQUIfit®, LF 3600 push-in fittings
- Couplers: double shut-off, flat face
- Advanced PE tubing
- LIQUIfit® ball valves



Cooling Process

EXPECTED PERFORMANCE:

- Optimization of circuits
- Ensure the durability of equipment
- Improve productivity
- Simplify the maintenance of the machines
- Maximum flow

SUITABLE PARKER LEGRIS AND RECTUS RANGES:

- LIQUIfit® with metal adaptors, LF 3800 push-in fittings, Carstick® cartridges
- Stainless steel function fittings
- Couplers: series 200KL, 200KLEK, series 21, 70, 48
- PE, FEP, anti-spark PU tubing
- Manual ball valves, piloted valves, accessories



Life Sciences

EXPECTED PERFORMANCE:

- Compatible with oxygen handling
- No fluid contamination
- Safe quick connections
- Compliant with health regulations

SUITABLE PARKER LEGRIS AND RECTUS RANGES:

- LF 6800, LF 3800, LIQUIfit® push-in fittings
- Thermoplastic couplers: series 21, 48,
- PFA, PU clean, FEP, PE tubing
- Ball valves compatible with oxygen



Fields of Applications

Safety

EXPECTED PERFORMANCE:

- Safety of operators & equipment
- Quality & long lasting products
- Compliance with 2006/42/EC directive and ISO 13849-1

SUITABLE PARKER LEGRIS AND RECTUS RANGES:

- Blocking fittings & piloted non-return valves
- Soft start fittings
- Safety couplers
- Blowguns
- Lockable and vented ball valves



Food Process

EXPECTED PERFORMANCE:

- FDA compliance
- Easy-to-clean
- Chemical compatibility
- High temperature resistance

SUITABLE PARKER LEGRIS AND RECTUS RANGES:

- LIQUIfit®, LF 3600, LF 3800 push-in fittings
- Stainless steel function fittings
- Stainless steel couplers, single or double shut-off Series 20KA, 21KA, 25KA
- FEP, Advanced PE and PFA tubing



Railway

EXPECTED PERFORMANCE:

- Vibration resistance
- Compliance with standards: DIN EN61373, EC 61373
- Wide range of temperatures from -60°C to +170°C

SUITABLE PARKER LEGRIS AND RECTUS RANGES:

- LF 3000®, LF 3600 push-in fittings
- Flow control regulators, non-return valves, pressure regulators, soft start fitting, silencers
- Brass compression and nickel-plated brass spigot fittings
- Ball valves, universal series
- Fireproof PA, PE tubing
- LIQUIfit® and stainless steel ball valves



Regulations to Suit Market Quality Requirements

For all industrial applications



UL94



ISO 14743*

IP68



SUVA pro

DVGW

(O-rings in gas treatment)

For food process



For beverages



**KTW
W270**



For cleanroom
and medical
applications

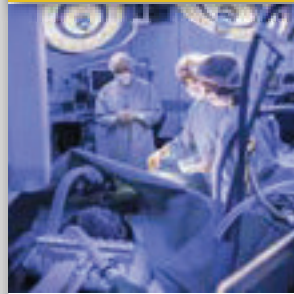

**USP
Class VI (A)**

ASTM G93

ISO 15001

For railways



EN 45545-2

DIN 5510-2

NF F16-101

*except chapter 9.8

Quality Management & Traceability



ISO certified, quality management is at the heart of all our processes throughout the value chain



- We guarantee the quality and traceability of every connector we sell
- Our products are 100% leak-tested
- Camera inspection checks the gripping ring conformity of our Legris products
- Certificates available online

Our Priority: Operator & Equipment Safety

Objective: **0 accidents**

Components within the Safety Control System

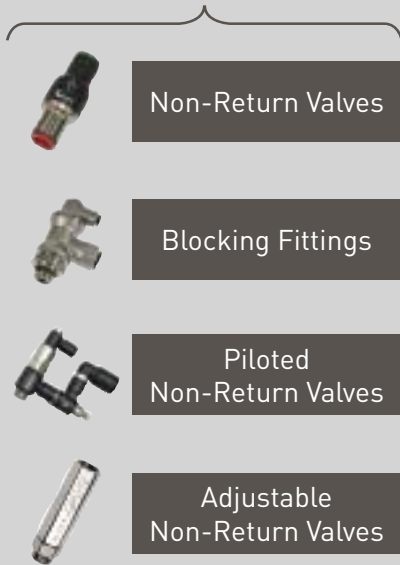

Components outside the Safety Control System

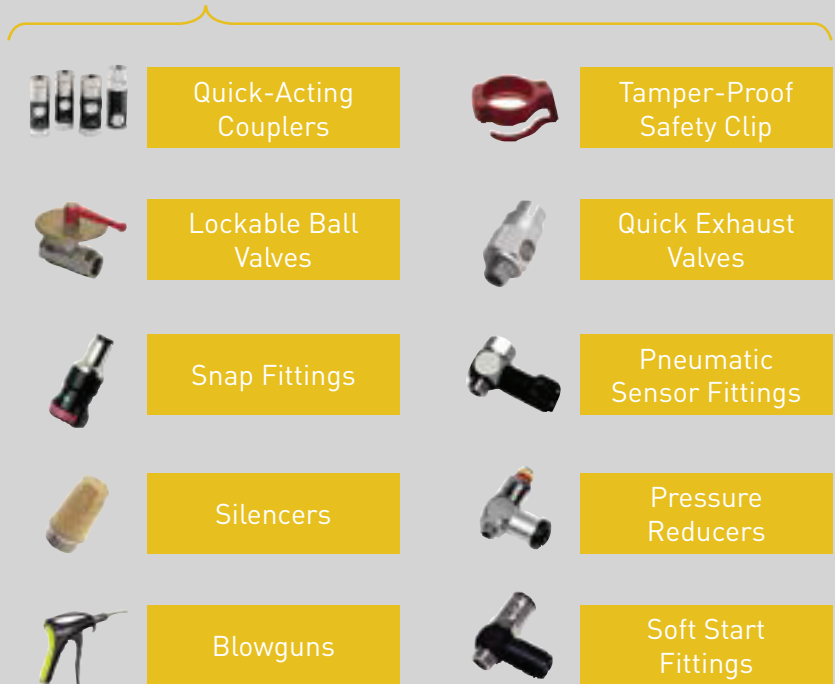

Safe Machine

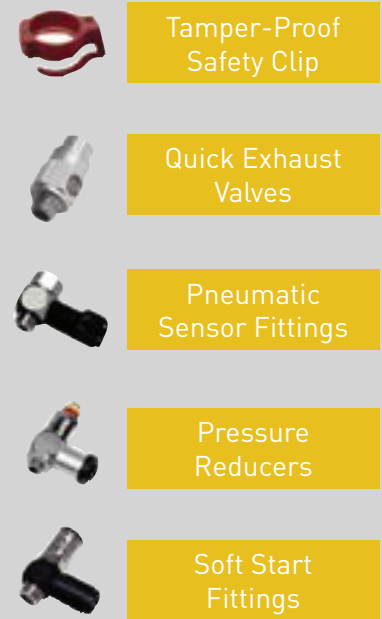

All the safety data is available on the **safety datasheet** at Parkerlegris.com and parker.com/LPCE



WASTE

Parker team members are applying their technical knowledge and creativity

- to simplify complex manufacturing processes,
- reduce production waste
- design products and systems that precisely balance performance and efficiency.

CO₂

This strategy fulfills a shared responsibility to solve challenges for customers while minimizing environmental impact.



Couplers or Fittings ? We Offer all the Solutions



Frequency of connection /Disconnection

- Frequent connection/disconnection : up to 10.000 times
- A few disconnections only: up to 5 times (before shortening the tube)



Indicator of total connection

- Audible "click" indicates connection
- "Tube end stop" when fully connected



Tubing or hose connection

- Used with hose barb connection
- Used with tubing connection



Pull resistance

- Ball locking system offers high resistance to pull force
- Collet technology provides pull force resistance on grooved rigid tubing



Disconnection under pressure

- Authorizes self venting or double shut-off options
- Not recommended for disconnecting under pressure



No drop-leaking

- Flat face technology, a solution for zero drop requirements
- Prefer a coupler solution, double shut off & flat face

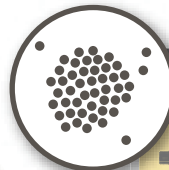

Space occupation

- See series 02: I.D. 1.5 mm
- See LF 3000® O.D. 3 mm



Lightweight

- Technical composite couplers offer a light solution
- A solution for weight saving



Robustness

- Refer to brass or stainless steel series
- Refer to metal or reinforced polymer fitting ranges



Pressure

- 250 bar (series 70 stainless steel)
- 550 bar (compression fittings)



Flow

- Up to 17.000 NI/min for straight through couplers
- Full flow technology



Temperature

- Up to +240°C, FFKM seal
- Up to 150°C, FKM seal

Table of Contents

Fittings	Push-In Fittings				
	 LF 3000® p.18	 LF 3200 p.41	 LIQUIfit® p.43	 LIQUIfit® metal adaptor p.55	 LF 3600 p.60
	Function Fittings				
	 Polymer Flow Control Regulators p.90	 Metal Flow Control Regulators p.99	 Blocking Fittings p.111	 Piloted Non-Return and Metal Quick Exhaust Valves p.113	 Non-Return Valves p.117
	Compression Fittings				
	 Brass Compression Fittings p.137	 Stainless Steel Compression Fittings p.151	 Spigot Fittings p.157		
	Accessories for Fittings				
	 Brass & nickel-plated p.163	 Brass adaptors p.168	 Stainless steel p.173	 Manifolds p.176	 Plugs p.177
	Couplings				
	 Brass & NP Brass p.200	 Stainless steel 303/316L p.281	 POM/PVDF p.297	 Accessories p.308	
Safety			Coded Systems	Mold	
 Safety Standard p.313	 Breathing Air Couplings p.318	 Self-Venting couplings p.322	 21/25 series p.349	 Brass, nickel-plated brass p.358	
Tubing & Blowguns					
 PA, Fireproof, Anti-sparks p.394	 PU, Anti-sparks, Anti-static p.398	 Advanced PE, PE p.403	 FEP, PFA p.405	 PA, PU, Braided p.408	
Industrial Valves					
Ball Valves					
 Universal p.444	 Universal Light p.449	 DVGW p.451	 Standard p.452	 Stainless Steel p.454	

Push-In Fittings				
 LF 3600 Low Lead Brass p.68	 LF 3800 p.71	 LF 6800 p.77	 LF 6100 p.80	 Accessories p.82
Function Fittings				
 Soft Start Fittings & Pressure Regulator Fittings p.123	 Pneumatic Sensor and Snap Fittings p.127	 Manually-Operated Valves p.131	 Silencers p.133	
Accessories for Fittings				
 Sealing p.182				
Flat Sealing				
 Brass, Stainless Steel p.309				
Hose Mold		Water		
 EPDM, PKR, PVC p.379	 Nickel-plated brass p.381			
Braided		Accessories		Blowguns & Nozzles
 PVC p.415	 Clips, Clamps, Tube-cutters p.421	 Polymer p.427	 Nozzles p.430	 Metal p.432
Needle & Butterfly			Axial Valves	
 High Pressure p.456	 Mini Ball Valves p.457	 LIQUIfit® p.459	 Needle and Butterfly Valves p.460	 p.463

Fittings

Couplings

Tubing & Blowguns

Industrial Valves

#01

FITTINGS

Push-in Fittings

Function Fittings

Compression Fittings

Adaptors and Manifolds



How to Choose Your Fittings

Key points to consider before choosing your industrial connector

What function do you need?

- Protect your system
- Detect end of cylinder rod stroke
- Control and improve the performance of your system
- Working on your system

What type of fluid is being conveyed?

- Compatibility of seal and connector materials with the fluid

What are the conditions of use?

- Vacuum
- Pressure
- Fluid temperature
- With or without seal
- Flow requirements

Which kind of thread do you need?

- Male thread/Female thread
- BSPP, BSPT, NPT, Metric



Which connector do you need?

- Push-In Fittings
- Compression Fittings
- Spigot Fittings
- Tailpiece Adaptors

Do you have compliance requirements?

- Norms & regulations
- ISO 9001/ISO TS 16949; RoHS, FDA, NSF
- Silicone-free, phthalates free, etc...
- Compatible materials with the application
- Chemical compatibility

What is your application environment?

- Ambient air quality (pollution)
- Risk of shocks
- Confined areas/access difficulties
- External uses (UV, saline environments)
- Use of products on mobile equipment

Have you thought about additional product requirements?

- Tubing
- Valves
- Couplings
- Blowguns

General Information on Fittings

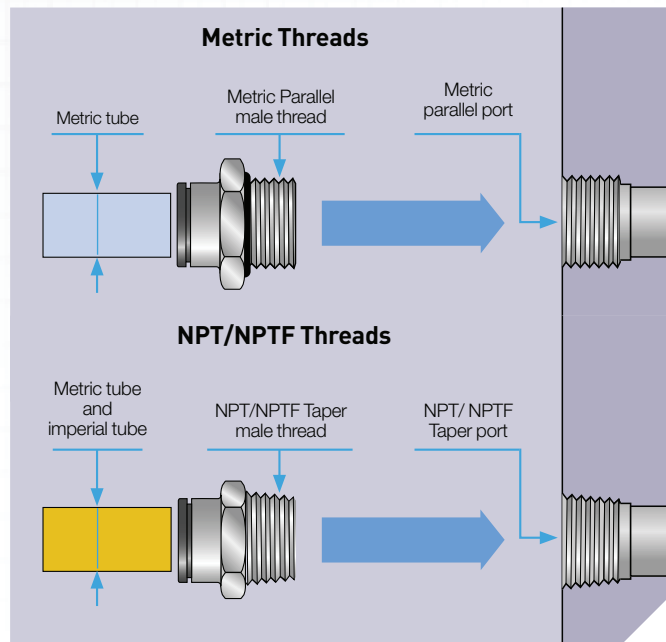
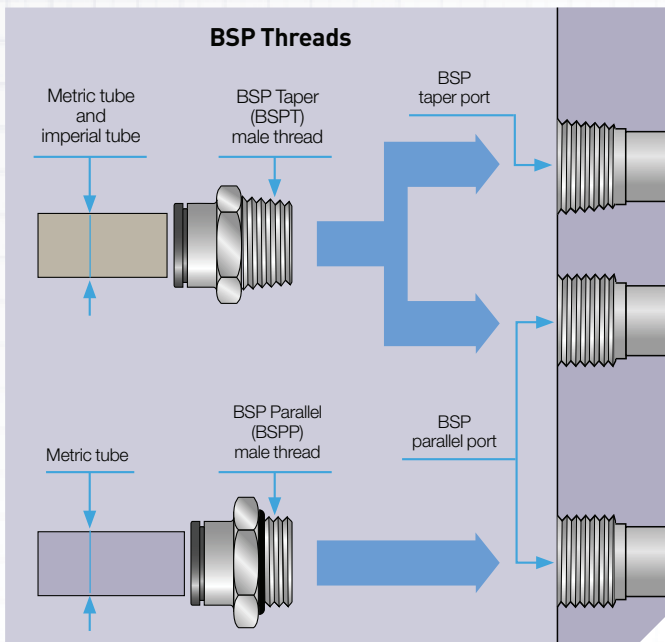

Push-In Fittings

Tube retention with gripping ring



- No damage to the tube
- Ideal for polymer tubes
- Particularly compact

Tube retention with collet

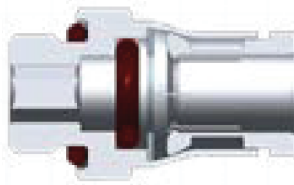

- Robust solution for harsh environments
- Resistant to high pressure, excellent lifespan
- Ideal for grooved metal tubes

Tube retention with reversed collet



- Protected disconnection
- Can withstand very high pressures
- Double sealing

Advantages

Allows flexible and modular systems to be assembled quickly.
 Provides a compact and lightweight connection solution.
 Facilitates installation due to a swivelling body.
 Reliability of the connection ensured through the one-piece design.

Suitable for use with a wide range of tubes.
 Prolongs the lifespan of your systems.

Compression Fittings



Connection and sealing achieved by crimping a metal olive onto a tube. The seals are metal to metal.

Advantages

Can withstand very high pressures and temperatures.
 Allows all types of tube to be connected, both polymer and metal.
 Increases the lifetime of the fitting.

Spigot Compression Fittings



Connection and sealing by the distortion and gripping of a plastic tube.

Advantages

Intended for the connection of very flexible or non-calibrated tubes.

Part Number Identification

The part numbers are selected using a technical mnemonic code.

Each fitting and valve is identified by:

- model series (4 digits)
- nominal diameter (2 digits)

Fittings

3101 06 10

Item type

Nominal diameter

Thread code

Nominal diameter code: equates to the outside diameter of the tube

Thread code: see tables below

When the product does not have a thread, the code used is: 00.

3101 Stud Fitting, Male BSPP and Metric Thread

Nickel-plated brass, NBR











You will find the part type at the top of each table

Thread Identification

BSP Thread	Code	NPT/NPTF Threads	Code
1/8"	10	1/16"	08
1/4"	13	1/8"	11
3/8"	17	1/4"	14
1/2"	21	3/8"	18
3/4"	27	1/2"	22
1"	34	3/4"	28
1 1/4"	42	1"	35
1 1/2"	49	1 1/4"	43
2"	48	1 1/2"	50
		2"	44

Metric Thread	Code	Metric Thread	Code	Metric Thread	Code
M3x0.5	09	M12x1.25	66	M22x1.5	82
M5x0.8	19	M12x1.5	67	M24x1.5	83
M6x1	52	M13x1.25	68	M27x1.5	85
M7x1	55	M14x1.25	70	M30x2	88
M8x1	56	M14x1.5	71	M33x1.5	90
M8x1.25	57	M16x1.25	74	M39x1.5	36
M10x1	60	M16x1.5	75	M42x1.5	37
M10x1.5	62	M18x1.5	78	M42x2	96
M12x1	65	M20x1.5	80	M48x2	98

Product Specifications Overview

	Materials	Fluids	Maximum Pressure (bar)	Temperature		Performance in Aggressive Environments		Page
				Min.	Max.	Mechanical	Chemical	
Push-In Fittings								
LF 3000® 	Technical polymer/ nickel-plated brass/ NBR	Compressed air	20	-20°C	+80°C	Good	Moderate	18
LF 3200 	Nickel-plated brass/ NBR	Compressed air	20	-15°C	+80°C	Excellent	Moderate	41
LIQUIfit® 	Bio-sourced polymer/ EPDM	Liquids	16	-10°C	+95°C	Moderate	Excellent	43
LIQUIfit® with Metal Adaptor 	Bio-sourced polymer/ nickel-plated brass FDA/stainless steel 316L/EPDM	Liquids	16	-10°C	+130°C for Ø4,6 and 8mm	Moderate	Excellent	55
LF 3600 	Nickel-plated brass FDA/FKM	All brass-compatible fluids	30	-25°C	+150°C	Excellent	Good	60
Low lead brass LF 3600 	Low lead brass FDA/FKM	All brass-compatible fluids, water	30	-25°C	+150°C	Excellent	Good	68
LF 3800 	Stainless steel 316L/ FKM	All fluids	30	-25°C	+150°C	Excellent	Excellent	71
LF 6800 	Nickel-plated brass/ EPDM	O ₂ , analytical gases	15	-10°C	+95°C	Moderate	Excellent	77
LF 6100 	Brass/NBR	All brass-compatible fluids	60	-40°C	+120°C	Excellent	Excellent	80

LF 3000® Push-In Fittings / Stud Fittings



A range of technical polymer fittings to cover most needs of low pressure pneumatic applications.

Ø metric: 3 to 16 mm
Ø inch: 1/8" to 1/2"

Technical Characteristics

- **Compatible Fluids:** Compressed air
Other fluids: please consult us
- **Working Pressure:** Vacuum to 20 bar
- **Working Temperature:** -20°C to +80°C

Tightening Torque (daN.m)	Threads								
	M3 x0.5	M5 x0.8	M7 x1	M10 x1	M12 x1.5	G1/8	G1/4	G3/8	G1/2
	0.06	0.16	0.8	0.8	1.1	0.8	1.2	3	3.5

Reliable performance is dependent upon the type of fluid conveyed, component materials and tubing being used.

Use is guaranteed with a vacuum of 755 mm Hg (99% vacuum).

Advantages

- Robust, lightweight, compact to build your pneumatic circuits
- Full flow connections to optimize flow rates
- Use in vacuum as well as in compressed air
- Customised products upon request. Please, contact us.

Component Materials

Silicone-free

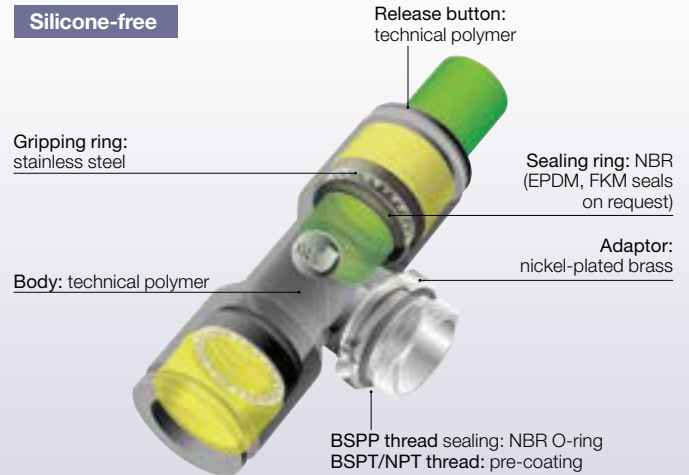

Regulations

- ISO 14743
- PED
- RoHS
- REACH

3175 Stud Fitting, Male BSPT Thread

Nickel-plated brass, NBR

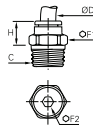

ØD	C		F1	F2	H	Kg
4	R1/8	3175 04 10	10	3	9.5	0.005
	R1/4	3175 04 13	14	3	6.5	0.011
	R3/8	3175 04 17	17	3	8	0.024
6	R1/8	3175 06 10	11	4	11.5	0.005
	R1/4	3175 06 13	14	4	8.5	0.011
	R3/8	3175 06 17	17	4	8.5	0.021
8	R1/2	3175 06 21	21	4	9	0.043
	R1/8	3175 08 10	13	5	20	0.011
	R1/4	3175 08 13	14	6	17	0.014
10	R3/8	3175 08 17	17	6	13	0.021
	R1/2	3175 08 21	21	6	12	0.039
	R1/8	3175 10 10	16	5	22.5	0.017
12	R1/4	3175 10 13	16	7	20	0.017
	R3/8	3175 10 17	17	8	16.5	0.019
	R1/2	3175 10 21	21	8	14	0.036
14	R1/4	3175 12 13	19	7	26.5	0.029
	R3/8	3175 12 17	19	9	24	0.028
	R1/2	3175 12 21	21	10	19.5	0.036
16	R3/8	3175 14 17	22	9	28.5	0.044
	R1/2	3175 14 21	24	10	23.5	0.046
	R3/8	3175 16 17	27	9	32.5	0.068
	R1/2	3175 16 21	27	12	32.5	0.079

Pre-coated thread

3175 Stud Fitting, Male NPT Thread

Nickel-plated brass, NBR

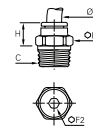

ØD	C		F1	F2	H	Kg
6	NPT1/8	3175 06 11	11	4	11.5	0.006
	NPT1/4	3175 06 14	14	4	8.5	0.012
	NPT1/4	3175 10 14	16	7	20	0.018
10	NPT3/8	3175 10 18	18	8	16.5	0.023
	NPT1/2	3175 10 22	22	8	14	0.038
12	NPT3/8	3175 12 18	19	9	24	0.030
	NPT1/2	3175 12 22	22	10	19.5	0.037

Pre-coated thread
5/32"(4 mm) and 5/16"(8 mm) are also available.

LF 3000® Push-In Fittings / Stud Fittings

3175 Stud Fitting, Male NPT Thread

Inch

Nickel-plated brass, NBR

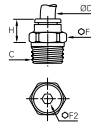

ØD	C		F1	F2	H	Kg
1/8	NPT1/8	3175 53 11	11	2	7.2	0.006
	NPT1/4	3175 53 14	14	2	8	0.015
	NPT1/8	3175 56 11	11	4	11.9	0.007
1/4	NPT1/4	3175 56 14	14	4	9.4	0.013
	NPT3/8	3175 56 18	18	5	7.6	0.024
3/8	NPT1/8	3175 60 11	16	4	22.7	0.019
	NPT1/4	3175 60 14	16	7	20.5	0.019
1/2	NPT3/8	3175 62 18	22	9.5	25.9	0.048
	NPT1/2	3175 62 22	24	9.5	22.1	0.064

Pre-coated thread

3175 Stud Fitting, Male BSPT Thread

Inch

Nickel-plated brass, NBR

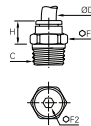

ØD	C		F1	F2	H	Kg
1/8	R1/8	3175 53 10	11	3	8.5	0.005
3/16	R1/8	3175 55 10	11.1	3.2	15.5	0.009
	R1/4	3175 55 13	14.3	4	15	0.020
1/4	R1/8	3175 56 10	11	4	12	0.006
	R1/4	3175 56 13	14	4	9.5	0.021
3/8	R1/4	3175 60 13	16	7	20.5	0.018
	R3/8	3175 60 17	17	7	16.5	0.019
1/2	R1/2	3175 60 21	21	7	14	0.037
	R1/4	3175 62 13	22	6	26.9	0.044
1/2	R3/8	3175 62 17	22	7	25.9	0.048
	R1/2	3175 62 21	24	7	20.5	0.049

Pre-coated thread

3101 Stud Fitting, Male BSPP and Metric Thread

Nickel-plated brass, NBR

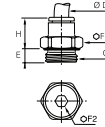

ØD	C		E	F1	F2	H	Kg
3	M3x0.5	3101 03 09*	2.5	8		12.5	0.003
	M5x0.8	3101 03 19	3.5	8	2.5	12.5	0.004
4	M3x0.5	3101 04 09*	2.5	8		14.5	0.003
	M5x0.8	3101 04 19	3	9	2.5	14	0.004
6	M7x1	3101 04 55	5	10	2.5	14	0.004
	G1/8	3101 04 10	5	13	3	11.5	0.007
8	G1/4	3101 04 13	5.5	16	3	10.5	0.011
	M5x0.8	3101 06 19	3.5	11	2.5	16	0.005
10	M7x1	3101 06 55	5	10	3	16	0.006
	M10x1	3101 06 60	5	13	4	13	0.007
12	M12x1.5	3101 06 67	5.5	15	4	13	0.009
	G1/8	3101 06 10	5	13	4	13	0.007
14	G1/4	3101 06 13	5.5	16	4	12.5	0.011
	G3/8	3101 06 17	5.5	20	4	13	0.020
16	G1/2	3101 06 21	7	24	4	20	0.039
	M10x1	3101 08 60	5	13	5	21	0.011
18	M12x1.5	3101 08 67	5.5	15	5	21	0.015
	G1/8	3101 08 10	4.5	13	5	20.5	0.011
20	G1/4	3101 08 13	5.5	16	6	19.5	0.016
	G3/8	3101 08 17	5.5	20	6	18	0.022
22	G1/2	3101 08 21	7	24	6	16.5	0.038
	G1/4	3101 10 13	5.5	16	7	23	0.018
24	G3/8	3101 10 17	5.5	20	8	19.5	0.021
	G1/2	3101 10 21	7	24	8	18.5	0.033
26	G1/4	3101 12 13	5.5	19	7	27.5	0.027
	G3/8	3101 12 17	5.5	20	9	27	0.028
28	G1/2	3101 12 21	7	24	11	22.5	0.035
	G3/8	3101 14 17	5.5	22	9	29.5	0.041
30	G1/2	3101 14 21	7	24	11	28	0.046
	G3/8	3101 16 17	7.5	27	9	32.5	0.061
32	G1/2	3101 16 21	9	27	12	32.5	0.068

*Bi-material O ring seal

3181 Stud Fitting Round Body, Male Metric Thread

Nickel-plated brass, NBR

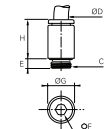

ØD	C		E	F	G	H	Kg
4	M5x0.8	3181 04 19	3.5	2.5	8.5	14.5	0.003
	M7x1	3181 04 55	5	3	10	14	0.004
6	M5x0.8	3181 06 19	3.5	2.5	11	16.5	0.005
	M7x1	3181 06 55	5	3	10	16	0.005

The internal hexagon and circular external shape ensure that model 3181 provides highly compact assembly.

They can be easily installed with an Allen key without the need of a spanner.

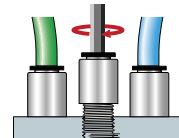

LF 3000® Push-In Fittings / Stud Fittings

3114 Stud Fitting, Female BSPP and Metric Thread

Nickel-plated brass, NBR

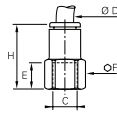

ØD	C		E	F	H	Kg
4	M5x0.8	3114 04 19	6.5	8	19.5	0.005
	G1/8	3114 04 10	9.5	13	22.5	0.010
6	G1/4	3114 04 13	13.5	16	26.5	0.015
	G1/8	3114 06 10	9.5	13	24.5	0.011
8	G1/4	3114 06 13	13.5	16	28.5	0.016
	G1/8	3114 08 10	9.5	13	29	0.015
10	G1/4	3114 08 13	13.5	16	33	0.021
	G3/8	3114 08 17	14	19	34	0.025
12	G1/4	3114 10 13	13.5	16	36	0.028
	G3/8	3114 10 17	14	19	36	0.027
14	G1/2	3114 10 21	19.5	24	41.5	0.047
	G3/8	3114 12 17	14	19	40	0.033
16	G1/2	3114 12 21	19.5	24	45.5	0.052
	G3/8	3114 14 17	14	22	42.5	0.057
16	G1/2	3114 16 21	15	27	49	0.096

3131 Stud Standpipe, Male BSPP and Metric Thread

Technical polymer, Nickel-plated brass, NBR

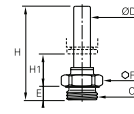

ØD	C		E	F	H	H1	Kg
4	M5x0.8	3131 04 19	3.5	8	31	16	0.002
	G1/8	3131 04 10	5	13	30	13.5	0.005
6	G1/4	3131 04 13	5.5	16	31	13.5	0.010
	G1/8	3131 06 10	5	13	32	13.5	0.005
8	G1/4	3131 06 13	5.5	16	33	13.5	0.010
	G1/8	3131 08 10	5	13	35.5	12.5	0.008
10	G1/4	3131 08 13	5.5	16	34.5	10.5	0.010
	G3/8	3131 08 17	5.5	20	34.5	10.5	0.015
12	G1/4	3131 10 13	5.5	16	43.5	17.5	0.012
	G3/8	3131 10 17	5.5	20	41.5	15.5	0.015
14	G1/2	3131 10 21	7	24	41.5	15.5	0.024
	G3/8	3131 12 17	5.5	20	42	12	0.015
16	G1/2	3131 12 21	7	24	43.5	12	0.024
	G3/8	3131 14 17	5.5	20	46.5	14	0.016
16	G1/2	3131 14 21	7	24	48	13.5	0.025

3121 Stud Standpipe, Male BSPT Thread

Technical polymer, Nickel-plated brass

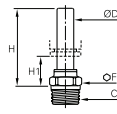

ØD	C		F	H	H1	Kg
4	R1/8	3121 04 10	10	26	14	0.005
	R1/4	3121 04 13	14	26.5	14.5	0.014
6	R1/8	3121 06 10	10	28	14	0.005
	R1/4	3121 06 13	14	28.5	14.5	0.014
8	R1/8	3121 08 10	10	29.5	11	0.005
	R1/4	3121 08 13	14	28.5	10	0.012
10	R1/4	3121 10 13	15	36	15.5	0.012
	R3/8	3121 10 17	17	36	15.5	0.017
12	R1/2	3121 10 21	21	36	15.5	0.032
	R3/8	3121 12 17	17	36.5	12	0.018
16	R1/2	3121 12 21	21	36.5	12	0.030

Pre-coated thread

3109 Stud Elbow, Male BSPT Thread

Technical polymer, Nickel-plated brass, NBR

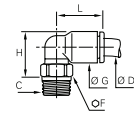

ØD	C		F	G	H	L	Kg
4	R1/8	3109 04 10	10	8.5	13.5	14	0.006
	R1/4	3109 04 13	14	8.5	14	14	0.015
6	R3/8	3109 04 17	17	8.5	13.5	14	0.019
	R1/8	3109 06 10	10	10.5	15.5	16	0.006
8	R1/4	3109 06 13	14	10.5	16	16	0.015
	R3/8	3109 06 17	17	10.5	16	16	0.020
10	R1/2	3109 06 21	21	10.5	16.5	16	0.035
	R1/8	3109 08 10	10	13.5	19	23	0.007
12	R1/4	3109 08 13	14	13.5	18	23	0.014
	R3/8	3109 08 17	17	13.5	18	23	0.018
14	R1/2	3109 08 21	21	13.5	19.5	23	0.032
	R1/8	3109 10 10	15	16	23	26.5	0.012
16	R1/4	3109 10 13	15	16	22	26.5	0.014
	R3/8	3109 10 17	17	16	22	26.5	0.020
16	R1/2	3109 10 21	21	16	22	26.5	0.034
	R1/4	3109 12 13	15	19	25	31	0.016
16	R3/8	3109 12 17	17	19	25	31	0.022
	R1/2	3109 12 21	21	19	25	31	0.037
16	R3/8	3109 14 17	20	22	30.5	35.5	0.031
	R1/2	3109 14 21	24	22	28.5	35.5	0.042
16	R3/8	3109 16 17	27	27	53	39	0.106
	R1/2	3109 16 21	27	27	53	39	0.104

Pre-coated thread
The body swivels for positioning purposes.

3109 Stud Elbow, Male NPT Thread

Technical polymer, Nickel-plated brass, NBR

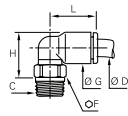

ØD	C		F	G	H	L	Kg
4	NPT1/8	3109 04 11	11	8.4	13.5	14	0.007
	NPT1/4	3109 04 14	14	8.4	14	14	0.016
6	NPT1/8	3109 06 11	11	10.5	15.5	16	0.007
	NPT1/4	3109 06 14	14	10.5	16	16	0.016
8	NPT1/8	3109 08 11	11	13.5	19	23.1	0.009
	NPT1/4	3109 08 14	14	13.5	18	23.1	0.015
	NPT1/4	3109 10 14	15	16	23	26.5	0.017
10	NPT3/8	3109 10 18	18	16	22	26.5	0.023
	NPT1/2	3109 10 22	22	16	23	26.5	0.046
	NPT1/2	3109 12 22	22	19	26	31	0.048

Pre-coated thread
The body swivels for positioning purposes.

3109 Stud Elbow, Male NPT Thread Inch

Technical polymer, Nickel-plated brass, NBR

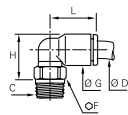

ØD	C		F	G	H	L	Kg
1/8	NPT1/8	3109 53 11	11	8.6	13.5	14.5	0.007
	NPT1/4	3109 53 14	14	8.6	14	14.5	0.015
1/4	NPT1/8	3109 56 11	11	11	17	18	0.008
	NPT1/4	3109 56 14	14	11	16	18	0.014
	NPT3/8	3109 56 18	18	11	16.5	18	0.021
3/8	NPT1/8	3109 60 11	15	16	23.1	27.4	0.014
	NPT1/4	3109 60 14	15	16	23.1	27.4	0.017
	NPT3/8	3109 60 18	18	16	22.1	27.4	0.024
1/2	NPT3/8	3109 62 18	20	22.1	31	35.1	0.033
	NPT1/2	3109 62 22	24	22.1	28.4	35.1	0.045

Pre-coated thread
The body swivels for positioning purposes.
5/32"(4 mm) and 5/16"(8 mm) are also available.

3109 Stud Elbow, Male BSPT Thread Inch

Technical polymer, Nickel-plated brass, NBR

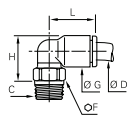

ØD	C		F	G	H	L	Kg
1/8	R1/8	3109 53 10	10	8.6	13.5	14.5	0.011
1/4	R1/8	3109 56 10	10	11	17	18	0.006
	R1/4	3109 56 13	14	11	17	18	0.013
3/8	R1/4	3109 60 13	15	16	22.1	26.4	0.016
	R3/8	3109 60 17	17	16	22.1	26.4	0.054
1/2	R1/4	3109 62 13	20	22.1	31	35.1	0.064
	R3/8	3109 62 17	20	22.1	31	35.1	0.067
	R1/2	3109 62 21	24	22.1	28.4	35.1	0.046

Pre-coated thread
The body swivels for positioning purposes.
5/32"(4 mm) and 5/16"(8 mm) are also available.

3199 Stud Elbow, Male BSPP and Metric Thread

Technical polymer, Nickel-plated brass, NBR

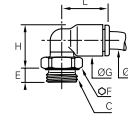

ØD	C		E	F	G	H	L	Kg
3	M3x0.5	3199 03 09*	2.5	8	8.5	15	14.5	0.003
	M5x0.8	3199 03 19	3.5	8	8.5	13.5	14.5	0.003
4	M3x0.5	3199 04 09*	2.5	8	8.5	15	14.5	0.003
	M5x0.8	3199 04 19	3.5	8	8.5	13.5	14	0.002
	M7x1	3199 04 55	4.5	10	8.5	15	14	0.005
6	G1/8	3199 04 10	5	13	8.5	13	14	0.006
	G1/4	3199 04 13	5.5	16	8.5	13	14	0.011
	M5x0.8	3199 06 19	3.5	8	10.5	15.5	16	0.003
	M7x1	3199 06 55	4.5	10	10.5	17.5	16	0.006
	M10x1	3199 06 60	5	13	10.5	15	14	0.006
	M12x1.5	3199 06 67	5.5	15	10.5	15	16	0.009
8	G1/8	3199 06 10	5	13	10.5	15	16	0.006
	G1/4	3199 06 13	5.5	16	10.5	15	16	0.011
	G3/8	3199 06 17	5.5	20	10.5	15.5	16	0.022
	G1/2	3199 06 21	7	24	10.5	16	16	0.027
	M10x1	3199 08 60	5	13	13.5	20.5	23	0.009
10	M12x1.5	3199 08 67	5.5	15	13.5	18	23	0.009
	G1/8	3199 08 10	4.5	13	13.5	20.5	23	0.009
	G1/4	3199 08 13	5.5	16	13.5	18.5	23	0.012
12	G3/8	3199 08 17	5.5	20	13.5	18.5	23	0.017
	G1/2	3199 08 21	7	24	13.5	19	23	0.027
	G1/4	3199 10 13	5.5	16	16	23.5	26.5	0.014
	G3/8	3199 10 17	5.5	20	16	22	26.5	0.017
14	G1/2	3199 10 21	7	24	16	22	26.5	0.026
	G1/4	3199 12 13	5.5	16	19	26.5	31	0.016
16	G3/8	3199 12 17	5.5	20	19	25	31	0.019
	G1/2	3199 12 21	7	24	19	25	31	0.029
14	G3/8	3199 14 17	5.5	20	22	32.5	35.5	0.029
	G1/2	3199 14 21	7	24	22	27	35.5	0.028
16	G3/8	3199 16 17	7.5	27	27	54.5	39	0.101
	G1/2	3199 16 21	9	27	27	54.5	39	0.097

The body swivels for positioning purposes.
*Bi-material seal

LF 3000® Push-In Fittings / Stud Fittings

3192 Stud Elbow, Female BSPP Thread

Technical polymer, Nickel-plated brass, NBR

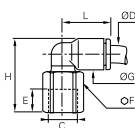

ØD	C		E	F	G	H	L	Kg
4	G1/8	3192 04 10	8.5	13	8.5	23	14	0.010
	G1/4	3192 04 13	11.5	16	8.5	27	14	0.016
6	G1/8	3192 06 10	8.5	13	10.5	25	16	0.010
	G1/4	3192 06 13	11.5	16	10.5	29	16	0.017
8	G1/8	3192 08 10	8.5	13	13.5	28	23	0.012
	G1/4	3192 08 13	11.5	16	13.5	32	23	0.020
10	G3/8	3192 08 17	12	19	13.5	33	23	0.026
	G1/4	3192 10 13	11	16	16	34.5	26.5	0.020
12	G3/8	3192 10 17	12	19	16	35	26.5	0.025
	G1/2	3192 10 21	16	24	16	41	26.5	0.048
14	G1/4	3192 12 13	11	16	19	38	30.5	0.022
	G3/8	3192 12 17	12	19	19	38.5	30.5	0.027
16	G1/2	3192 12 21	16	24	19	43.5	30.5	0.050

The body swivels for positioning purposes.

3169 Extended Stud Elbow, Male BSPP and Metric Thread

Technical polymer, Nickel-plated brass, NBR

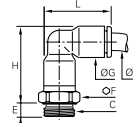

ØD	C		E	F	G	H	L	Kg
4	M5x0.8	3169 04 19	3.5	8	8.5	23	19	0.006
	G1/8	3169 04 10	5	13	8.5	22.5	19	0.008
6	G1/4	3169 04 13	5.5	16	8.5	22.5	19	0.014
	M5x0.8	3169 06 19	3.5	10	10.5	27.5	23	0.008
8	M7x1	3169 06 55	4.5	10	10.5	26	23	0.012
	G1/8	3169 06 10	5	13	10.5	27	23	0.011
10	G1/4	3169 06 13	5.5	16	10.5	27	23	0.016
	G1/8	3169 08 10	5	13	13.5	36	29.5	0.018
12	G3/8	3169 08 17	5.5	16	13.5	33	29.5	0.028
	G1/4	3169 10 13	5.5	16	16	40.5	34.5	0.028
14	G3/8	3169 10 17	5.5	20	16	40.5	34.5	0.036
	G1/2	3169 10 21	7	24	16	40.5	34.5	0.049
16	G1/4	3169 12 13	5.5	19	19	44.5	40.5	0.044
	G3/8	3169 12 17	5.5	20	19	42	40.5	0.038
18	G1/2	3169 12 21	7	24	19	42	40.5	0.043
	G3/8	3169 14 17	5.5	22	22	51	46.5	0.059
20	G1/2	3169 14 21	7	24	22	48.5	46.5	0.063
	G3/8	3169 16 17	7.5	27	27	82.5	52	0.220
22	G1/2	3169 16 21	9	27	27	82.5	52	0.206

The body swivels for positioning purposes.

3129 Extended Stud Elbow, Male BSPT Thread

Technical polymer, Nickel-plated brass, NBR

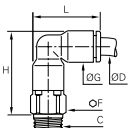

ØD	C		F	G	H	L	Kg
4	R1/8	3129 04 10	10	8.5	23	19	0.008
	R1/4	3129 04 13	14	8.5	23.5	19	0.018
6	R1/8	3129 06 10	10	10.5	27	22.5	0.010
	R1/4	3129 06 13	14	10.5	27.5	22.5	0.020
8	R1/8	3129 08 10	13	13.5	34.5	29.5	0.018
	R1/4	3129 08 13	14	13.5	32.5	29.5	0.022
10	R3/8	3129 08 17	17	13.5	33	29.5	0.032
	R1/4	3129 10 13	15	16	39.5	34.5	0.031
12	R3/8	3129 10 17	17	16	39.5	34.5	0.042
	R1/2	3129 10 21	21	16	39.5	34.5	0.058
14	R1/4	3129 12 13	19	19	45.5	40.5	0.051
	R3/8	3129 12 17	19	19	45.5	40.5	0.047
16	R1/2	3129 12 21	21	19	45.5	40.5	0.053
	R3/8	3129 14 17	21	22	51.5	46.5	0.065
18	R1/2	3129 14 21	21	22	51.5	46.5	0.071

Pre-coated thread

The body swivels for positioning purposes.

3113 45° Elbow, Male BSPT Thread

Technical polymer, Nickel-plated brass, NBR

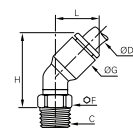

ØD	C		F	G	H	L	Kg
4	R1/8	3113 04 10	10	9	21	13	0.006
	R1/8	3113 06 10	10	11	24.5	14.5	0.006
6	R1/4	3113 06 13	14	11	25	14.5	0.015
	R1/8	3113 08 10	10	13.5	30	19.5	0.007
8	R1/4	3113 08 13	14	13.5	28.5	19.5	0.014
	R3/8	3113 08 17	17	13.5	28.5	19.5	0.018
10	R1/4	3113 10 13	15	16	33.5	23	0.014
	R3/8	3113 10 17	17	16	33.5	23	0.020
12	R1/2	3113 10 21	21	16	34	23	0.032
	R1/4	3113 12 13	15	19	39	26	0.016
14	R3/8	3113 12 17	17	19	39	26	0.022
	R1/2	3113 12 21	21	19	39	26	0.034

Pre-coated thread

The body swivels for positioning purposes.

This model prevents distortion of the tube.

3133 45° Elbow, Male BSPP and Metric Thread

Technical polymer, Nickel-plated brass, NBR

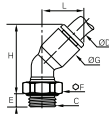

ØD	C		E	F	G	H	L	Kg
4	M5x0.8	3133 04 19	3.5	8	9	23	13	0.003
	G1/8	3133 04 10	4.5	13	9	20.5	13	0.006
6	M5x0.8	3133 06 19	3.5	8	11	28	14.5	0.003
	G1/8	3133 06 10	4.5	13	11	24	14.5	0.006
6	G1/4	3133 06 13	5.5	16	11	24	14.5	0.011
	G1/8	3133 08 10	4.5	13	13.5	31	19.5	0.009
8	G1/4	3133 08 13	5.5	16	13.5	29	19.5	0.012
	G3/8	3133 08 17	5.5	20	13.5	29	19.5	0.017
8	G1/4	3133 10 13	5.5	16	16	35	23	0.014
	G3/8	3133 10 17	5.5	20	16	33.5	23	0.017
10	G1/2	3133 10 21	7	24	16	33.5	23	0.026
	G1/4	3133 12 13	5.5	16	19	40.5	26	0.016
12	G3/8	3133 12 17	5.5	20	19	39	26	0.019
	G1/2	3133 12 21	7	24	19	39	26	0.029

The body swivels for positioning purposes.
This model prevents distortion of the tube.

3198 Stud Branch Tee, Male BSPP and Metric Thread

Technical polymer, Nickel-plated brass, NBR

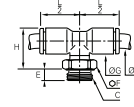

ØD	C		E	F	G	H	L/2	Kg
4	M5x0.8	3198 04 19	3.5	8	8.5	17.5	14	0.003
	G1/8	3198 04 10	5	13	8.5	15	14	0.006
4	G1/4	3198 04 13	5.5	16	8.5	15	14	0.011
	M5x0.8	3198 06 19	3.5	8	10.5	19.5	16	0.004
6	G1/8	3198 06 10	5	13	10.5	17	16	0.007
	G1/4	3198 06 13	5.5	16	10.5	17	16	0.012
6	G1/8	3198 08 10	4.5	13	13.5	23.5	23	0.011
	G1/4	3198 08 13	5.5	16	13.5	21.5	23	0.014
8	G3/8	3198 08 17	5.5	20	13.5	21.5	23	0.019
	G1/4	3198 10 13	5.5	16	16	26	26.5	0.017
10	G3/8	3198 10 17	5.5	20	16	24	26.5	0.020
	G1/2	3198 10 21	7	24	16	24	26.5	0.029
10	G1/4	3198 12 13	5.5	16	19	29	31	0.021
	G3/8	3198 12 17	5.5	20	19	27	31	0.024
12	G1/2	3198 12 21	7	24	19	27	31	0.033
	G3/8	3198 14 17	5.5	20	22	32.5	35.5	0.036
14	G1/2	3198 14 21	7	24	22	27	35.5	0.036
	G3/8	3198 16 17	7.5	27	27	54.5	38.5	0.121
16	G1/2	3198 16 21	9	27	27	54.5	38.5	0.117

The body swivels for positioning purposes.

3108 Stud Branch Tee, Male BSPT Thread

Technical polymer, Nickel-plated brass, NBR

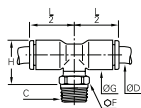

ØD	C		F	G	H	L/2	Kg
4	R1/8	3108 04 10	10	8.5	15.5	14	0.006
	R1/4	3108 04 13	14	8.5	16	14	0.015
6	R1/8	3108 06 10	10	10.5	17.5	16	0.007
	R1/4	3108 06 13	14	10.5	18	16	0.016
6	R1/8	3108 08 10	10	13.5	22	23	0.009
	R1/4	3108 08 13	14	13.5	21	23	0.016
8	R3/8	3108 08 17	17	13.5	21	23	0.020
	R1/4	3108 10 13	15	16	24	26.5	0.017
10	R3/8	3108 10 17	17	16	24	26.5	0.022
	R1/2	3108 10 21	21	16	24	26.5	0.034
10	R1/4	3108 12 13	15	19	27	31	0.021
	R3/8	3108 12 17	17	19	27	31	0.027
12	R1/2	3108 12 21	21	19	27	31	0.041
	R3/8	3108 14 17	20	22	30.5	35	0.038
14	R1/2	3108 14 21	24	22	28.5	35	0.049
	R3/8	3108 16 17	27	27	53	38.5	0.128
16	R1/2	3108 16 21	27	27	53	38.5	0.124

Pre-coated thread
The body swivels for positioning purposes.

3103 Stud Run Tee, BSPT Thread

Technical polymer, Nickel-plated brass, NBR

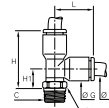

ØD	C		F	G	H	H1	L	Kg
4	R1/8	3103 04 10	10	8.5	23.5	9	14.5	0.006
	R1/4	3103 04 13	14	8.5	24	9.5	14.5	0.015
6	R1/8	3103 06 10	10	10.5	27.5	10	17.5	0.007
	R1/4	3103 06 13	14	10.5	28	10.5	17.5	0.016
6	R1/8	3103 08 10	10	13.5	35	12	23	0.009
	R1/4	3103 08 13	14	13.5	34	11	23	0.015
8	R3/8	3103 08 17	17	13.5	34	11	23	0.020
	R1/4	3103 10 13	15	16	40.5	14	26.5	0.017
10	R3/8	3103 10 17	17	16	40.5	14	26.5	0.022
	R1/2	3103 10 21	21	16	40.5	14	26.5	0.035
10	R1/4	3103 12 13	15	19	46.5	15.5	31	0.021
	R3/8	3103 12 17	17	19	46.5	15.5	31	0.026
12	R1/2	3103 12 21	21	19	46.5	15.5	31	0.041
	R3/8	3103 14 21	24	22	52.5	17.5	35.5	0.049
14	R3/8	3103 16 17	27	27	78	27	38.5	0.126
	R1/2	3103 16 21	27	27	78	27	38.5	0.124

Pre-coated thread
The body swivels for positioning purposes.

LF 3000® Push-In Fittings / Stud Fittings

3193 Stud Run Tee, Male BSPP and Metric Thread

Technical polymer, Nickel-plated brass, NBR

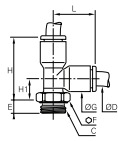

ØD	C		E	F	G	H	H1	L	Kg
4	M5x0.8	3193 04 19	3.5	8	8.5	26	11.5	14.5	0.003
	G1/8	3193 04 10	5	13	8.5	23	8.5	14.5	0.006
	G1/4	3193 04 13	5.5	16	8.5	23	8.5	14.5	0.011
6	M5x0.8	3193 06 19	3.5	8	10.5	29.5	12.5	17.5	0.004
	G1/8	3193 06 10	5	13	10.5	27	10	17.5	0.007
	G1/4	3193 06 13	5.5	16	10.5	27	10	17.5	0.012
8	G1/8	3193 08 10	4.5	13	13.5	36.5	14	23	0.011
	G1/4	3193 08 13	5.5	16	13.5	34.5	12	23	0.014
	G3/8	3193 08 17	5.5	20	13.5	34.5	12	23	0.019
10	G1/4	3193 10 13	5.5	16	16	42	15.5	26.5	0.017
	G3/8	3193 10 17	5.5	20	16	40.5	14	26.5	0.020
	G1/2	3193 10 21	7	24	16	40.5	14	26.5	0.029
12	G1/4	3193 12 13	5.5	16	19	48	17	31	0.021
	G3/8	3193 12 17	5.5	20	19	46.5	15.5	31	0.024
	G1/2	3193 12 21	7	24	19	46.5	15.5	31	0.033
14	G3/8	3193 14 17	5.5	20	22	56.5	21.5	35.5	0.036
	G1/2	3193 14 21	7	24	22	51	16	35.5	0.036
	G3/8	3193 16 17	7.5	27	27	79.5	41	38.5	0.121
16	G1/2	3193 16 21	9	27	27	79.5	41	38.5	0.117

The body swivels for positioning purposes.

3158 Y Piece, Male BSPP and Metric Thread

Technical polymer, Nickel-plated brass, NBR

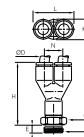

ØD	C		E	F	H	K	L	N	Kg
4	M5x0.8	3158 04 19	3.5	8	32.5	8.5	17.5	9	0.006
	M5x0.8	3158 06 19	3.5	10	39.5	10.5	21.5	11	0.009
6	G1/8	3158 06 10	5	13	39	10.5	21.5	11	0.012
	G1/4	3158 06 13	5.5	16	39.5	10.5	21.5	11	0.017
8	G1/8	3158 08 10	5	13	49	13.5	28	14.5	0.020
	G1/4	3158 08 13	5.5	16	49.5	13.5	28	14.5	0.023
	G3/8	3158 08 17	6	19	48	13.5	28	14.5	0.031
10	G1/4	3158 10 13	5.5	16	58	16	33	17	0.032
	G3/8	3158 10 17	6	20	57.5	16	33	17	0.040
12	G1/2	3158 10 21	7	24	58	16	33	17	0.054
	G3/8	3158 12 17	6	20	62	19	39	20	0.044
	G1/2	3158 12 21	7	24	63	19	39	20	0.050

The body swivels for positioning purposes.

3132 Double Y, Male BSPP Thread

Technical polymer, Nickel-plated brass, NBR

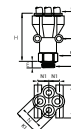

ØD	C		E	F	H	K	K1	N	N1	ØT	Kg
4	G1/8	3132 04 10	5	13	41	25.5	21	10	8.5	3.7	0.022
	G1/4	3132 04 13	5.5	16	40	25.5	21	10	8.5	3.7	0.026
6	G1/8	3132 06 10	5	19	53.5	31.5	26.5	12	10	3.7	0.041
	G1/4	3132 06 13	5.5	19	52.5	31.5	26.5	12	10	3.7	0.042

The body swivels for positioning purposes.

3148 Y Piece, Male BSPT Thread

Technical polymer, Nickel-plated brass, NBR

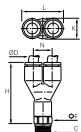

ØD	C		F	H	K	L	N	Kg
4	R1/8	3148 04 10	10	32.5	8.5	17.5	9	0.009
	R1/4	3148 04 13	14	33	8.5	17.5	9	0.018
6	R1/8	3148 06 10	10	39.5	10.5	21.5	11	0.012
	R1/4	3148 06 13	14	40	10.5	21.5	11	0.021
8	R1/8	3148 08 10	13	56.5	13.5	28	14.5	0.020
	R1/4	3148 08 13	14	55.5	13.5	28	14.5	0.025
	R3/8	3148 08 17	16	48.5	13.5	28	14.5	0.034
10	R1/4	3148 10 13	14	60	19	39	20	0.033
	R3/8	3148 10 17	16	60.5	19	39	20	0.043
	R1/2	3148 10 21	24	61	19	39	20	0.062
12	R3/8	3148 12 17	19	66	19	39	20	0.054
	R1/2	3148 12 21	21	66	19	39	20	0.059

Pre-coated thread

The body swivels for positioning purposes.

LF 3000® Push-In Fittings / Stud Fittings

3100 Carstick® Cartridge

Brass, NBR

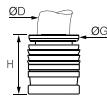

ØD		G	G1	H	L	Kg
4	3100 04 00	8	11	10	554	0.007
6	3100 06 00	10	14.5	11.5	629	0.002
8	3100 08 00	13	15	15	794	0.002
10	3100 10 00	15.5	19.5	17	930	0.005
12	3100 12 00	19.5	21	19.5	1038	0.010
14	3100 14 00	21	24.5	22.5	1110	0.013

50 cartridges per Carstick®.
Cavity dimensions are available upon request

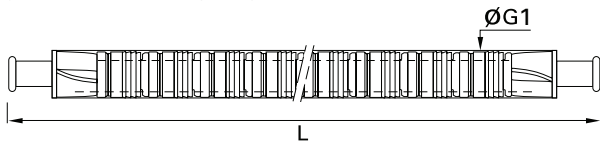

3100 Carstick® Cartridge

Inch

Nickel-plated brass, NBR

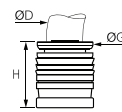

ØD		G	G1	H	L	Kg
1/8	3100 53 00 99	7	10	9	508	0.002
5/32	3100 04 00 99	8	11	10	554	0.007
1/4	3100 56 00 99	10.5	14.5	12	600	0.003
5/16	3100 08 00 99	13	15	15	794	0.002
3/8	3100 60 00 99	15.5	19	16.5	930	0.006

50 cartridges per Carstick®
(4 mm) and 5/16" (8 mm) also available.
Cavity dimensions are available upon request



Cavity Dimensions

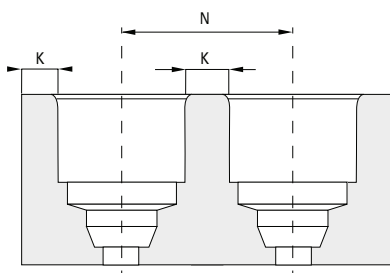
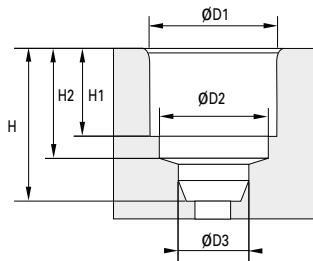

Carstick® Metric

Cavity	ØD3	H	H1	H2
4	4.1	10	6	8.15
6	6.1	12	7.5	9.65
8	8.15	15.5	9.9	12.45
10	10.25	19	11.7	14.35
12	12.17	22	13.9	16.75

Carstick® Inch

Cavity	ØD3	H	H1	H2
1/8	3.25	9.5	5.3	7.45
5/32*	4.1	10	6	8.15
1/4	6.45	12.5	8	10.15
5/16*	8.15	15.5	9.9	12.45
3/8	9.65	19	11.7	14.35

Polyamide Cavity

Cavity	ØD1	ØD2	N	K
4	8.25	7.05	9.8	1.5
6	10.2	9.15	12.2	2
8	12.15	10.85	14.2	2
10	14.8	13.2	16.8	2
12	17.5	15.5	20	2.5

Cavity	ØD1	ØD2	N	K
1/8	7.05	6.02	8.6	1.5
5/32*	8.25	7.05	9.75	1.5
1/4	10.55	9.35	12.6	2
5/16*	12.15	10.85	14.2	2
3/8	14.8	13.1	16.8	2

Aluminium Cavity

Cavity	ØD1	ØD2	N	K
4	8.25	7.5	11.5	3
6	10.3	9.15	13.5	3
8	12.2	10.85	15.2	3
10	15.05	13.2	17.1	2
12	17.5	15.5	20	2.5

Cavity	ØD1	ØD2	N	K
1/8	7.1	6.2	8.6	1.5
5/32*	8.25	7.05	11.25	3
1/4	10.6	9.35	12.65	2
5/16*	12.2	10.85	15.2	3
3/8	15.05	13.1	17.1	2

Brass Cavity

Cavity	ØD1	ØD2	N	K
4	8.25	7.05	10.25	2
6	10.25	9.1	12.25	2
8	12.2	10.85	14.25	2
10	15.05	13.2	17.1	2
12	17.65	15.5	20	2.5

Cavity	ØD1	ØD2	N	K
1/8	7.1	6.2	8.6	1.5
5/32*	8.25	7.05	10.25	2
1/4	10.6	9.35	12.65	2
5/16*	12.2	10.85	14.25	2
3/8	15.05	13.1	17.1	2

*5/32" = 4 mm and 5/16" = 8 mm

Please consult us for detailed drawings of cavity dimensions and tolerances.

All our dimensions are in millimeters.

LF 3000® Push-In Fittings / Tube-to-Tube Fittings

3106 Equal and Unequal Tube-to-Tube Connector

Technical polymer, NBR

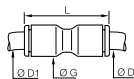

ØD	ØD1		G	L	Kg
3	3	3106 03 00	8.5	25	0.002
	4	3106 03 04	8.5	25	0.002
	1/4	3106 04 56	11	29.5	0.005
4	4	3106 04 00	8.5	25	0.001
	6	3106 04 06	11	28	0.002
	8	3106 04 08	13.5	38	0.005
1/4	1/4	3106 06 56	13.5	36	0.009
	6	3106 06 00	10.5	28.5	0.002
	8	3106 06 08	13.5	38	0.005
6	10	3106 06 10	16	42	0.008
	8	3106 08 00	13.5	38	0.004
	10	3106 08 10	16	42	0.007
8	12	3106 08 12	19	50.5	0.026
	10	3106 10 00	16	42	0.005
	12	3106 10 12	19	50.5	0.018
1/2	1/2	3106 12 62	22	56.5	0.041
	12	3106 12 00	19	50.5	0.009
	14	3106 12 14	22	56	0.025
16	16	3106 12 16	27	61	0.066
	14	3106 14 00	22	56	0.014
16	16	3106 16 00	27	60.5	0.041

3106 Equal and Unequal Tube-to-Tube Connector

Inch

Technical polymer, NBR

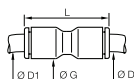

ØD	ØD1		G	L	Kg
1/4	1/4	3106 56 00	11	29.5	0.002
	3/8	3106 60 00	16	42	0.006
3/8	10	3106 60 10	12	50.5	0.028
	1/4	3106 60 56	16	41	0.016
1/2	1/2	3106 62 00	22	55	0.016

5/32"(4 mm) and 5/16"(8 mm) also available

3102 Equal and Unequal Elbow

Technical polymer, NBR

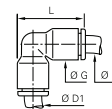

ØD	ØD1		G	L	Kg
4	4	3102 04 00	8.5	19	0.001
	6	3102 04 06	10.5	22.5	0.003
6	6	3102 06 00	10.5	22.5	0.002
	8	3102 06 08	13.5	29.5	0.008
8	8	3102 08 00	13.5	29.5	0.004
	10	3102 08 10	16	34.5	0.011
10	10	3102 10 00	16	34.5	0.006
	12	3102 10 12	19	40.5	0.019
12	12	3102 12 00	19	40.5	0.010
14	14	3102 14 00	22	46.5	0.015
16	16	3102 16 00	27	52	0.043

3102 Equal and Unequal Elbow

Inch

Technical polymer, NBR

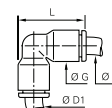

ØD	ØD1		G	L	Kg
1/4	1/4	3102 56 00	11	2.5	0.002
3/8	3/8	3102 60 00	16	34	0.006
1/2	1/2	3102 62 00	22	35	0.017

5/32"(4 mm) and 5/16"(8 mm) also available

3104 Equal and Unequal Tee

Technical polymer, NBR

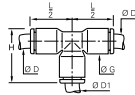

ØD	ØD1		G	H	L/2	Kg
3	3	3104 03 00	8.5	19	14.5	0.004
4	4	3104 04 00	8.5	19	14.5	0.002
	6	3104 04 06	10.5	22.5	17.5	0.007
6	4	3104 06 04	10.5	22.5	17.5	0.005
	6	3104 06 00	10.5	22.5	17.5	0.003
8	8	3104 06 08	13.5	29.5	23	0.015
	4	3104 08 04	13.5	29	17.5	0.013
8	6	3104 08 06	13.5	29.5	23	0.010
	8	3104 08 00	13.5	29.5	23	0.006
10	10	3104 08 10	16	34.5	26.5	0.020
	4	3104 10 04	16	33	26	0.023
	8	3104 10 08	16	34.5	26.5	0.014
10	10	3104 10 00	16	34.5	26.5	0.009
	12	3104 10 12	19	40.5	31	0.033
12	4	3104 12 04	19	39	31	0.040
	10	3104 12 10	19	40.5	31	0.023
12	12	3104 12 00	19	40.5	31	0.014
	8	3104 14 08	22	46	35.5	0.054
14	14	3104 14 00	22	46	35.5	0.022
16	12	3104 16 12	27	52.5	39	0.088
	16	3104 16 00	27	52	39	0.063

3104 Equal and Unequal Tee

Inch

Technical polymer, NBR

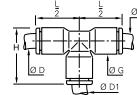

ØD	ØD1		G	H	L/2	Kg
5/32	1/4	3104 04 56	11	23.5	18	0.008
1/8	1/8	3104 53 00	8.4	19	14.5	0.003
	1/4	3104 53 56	11	23.5	18	0.011
3/16	3/16	3104 55 00	11	27.2	21.6	0.016
	5/32	3104 56 04	11	23.5	18.5	0.014
1/4	1/4	3104 56 00	11	23	24	0.003
	1/8	3104 56 53	11	23.5	18.5	0.007
	3/8	3104 56 60	16	33.5	24.5	0.017
3/8	1/4	3104 60 56	16	32.5	25.5	0.019
	3/8	3104 60 00	16	34	26	0.009
1/2	1/2	3104 62 00	22	46	35	0.026
	1/4	3104 62 56	22.1	45.2	35.3	0.059
	3/8	3104 62 60	22	46	35	0.047

5/32"(4 mm) and 5/16"(8 mm) also available

3140 Equal and Unequal Single Y Piece

Technical polymer, NBR

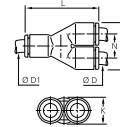

ØD	ØD1		H	K	L	N	Kg
4	4	3140 04 00	17.5	8.5	28.5	9	0.002
	6	3140 04 06	17.5	10.5	33	9	0.002
6	6	3140 06 00	21.5	10.5	35	11	0.004
	8	3140 06 08	22.5	13.5	41	11.5	0.005
8	8	3140 08 00	28	13.5	45	14.5	0.006
	10	3140 08 10	28	16	47	14.5	0.008
10	10	3140 10 00	33	16	53	17	0.010
	12	3140 10 12	33	19	57	17	0.012
12	12	3140 12 00	39	19	57	20	0.017

3107 Equal and Unequal Cross

Technical polymer, NBR

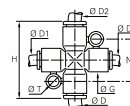

ØD	ØD1	ØD2		G	H	N	ØT	Kg
4	4	4	3107 04 00	11	36	20	4.2	0.014
6	4	6	3107 04 06	11	36	20	4.2	0.009
4	4	6	3107 06 04	11	36	20	4.2	0.011
6	6	6	3107 06 00	11	36	20	4.2	0.005
8	6	8	3107 06 08	11	46	22.5	4.2	0.018
6	6	8	3107 08 06	13.5	46	22.5	4.2	0.022
8	8	8	3107 08 00	13.5	46	22.5	4.2	0.009

LF 3000® Push-In Fittings / Bulkhead Connector Fittings

3116 Equal Bulkhead Connector

Technical polymer, NBR

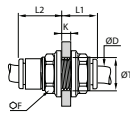

ØD		F	K max	L1	L2	ØT min	Kg
4	3116 04 00	13	5.5	15	10	10.5	0.003
6	3116 06 00	15	8	19	11.5	12.5	0.004
8	3116 08 00	18	14.5	25	13.5	15.5	0.007
10	3116 10 00	22	14.5	27.5	15.5	18.5	0.011
12	3116 12 00	26	18.5	33	18	22.5	0.019
14	3116 14 00	29	20.5	37.5	20.5	25.5	0.028

3136 Bulkhead Connector, Female BSPP Thread

Nickel-plated brass, NBR

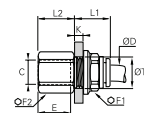

ØD	C		E	F1	F2	K max	L1	L2	ØT min	Kg
4	G1/8	3136 04 10	9.5	13	13	7	17	11.5	10.5	0.015
	G1/4	3136 04 13	13.5	13	16	7	17	15.5	10.5	0.021
6	G1/8	3136 06 10	9.5	15	15	8	19	10.5	12.5	0.021
	G1/4	3136 06 13	13.5	15	17	7	19	15.5	12.5	0.027
8	G3/8	3136 06 17	12	15	22	8	19	16	12.5	0.041
	G1/8	3136 08 10	9.5	18	17	8	20.5	10.5	15.5	0.029
10	G1/4	3136 08 13	13.5	18	17	8	20.5	14.5	15.5	0.029
	G3/8	3136 10 17	14	22	22	8.5	23	16	18.5	0.050
12	G3/8	3136 12 17	14	26	24	8.5	27	16	22.5	0.079
	G1/2	3136 12 21	19.5	26	27	8.5	27	21.5	22.5	0.098
16	G3/8	3136 16 17	12	29	29	10.5	30	15	27.5	0.125
	G1/2	3136 16 21	15	29	29	10.5	30	19.5	27.5	0.126

3146 Equal Mixed Bulkhead Connector

Nickel-plated brass, NBR

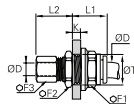

ØD		F1	F2	F3	K max	L1	L2	ØT min	Kg
4	3146 04 00	13	13	10	7	17.5	17.5	10.5	0.018
6	3146 06 00	15	17	13	8	19	18	12.5	0.028
8	3146 08 00	18	19	14	8	20.5	20.5	15.5	0.036
10	3146 10 00	22	22	19	8.5	23	24.5	18.5	0.062
12	3146 12 00	26	25	22	8.5	27	25	22.5	0.095
14	3146 14 00	29	29	24	10.5	27	27	25.5	0.124

Push-in connection with compression fitting

3139 Equal Bulkhead Elbow

Technical polymer, Nickel-plated brass, NBR

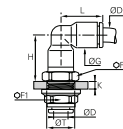

ØD		F	F1	G	H	K max	L	ØT min	Kg
4	3139 04 00	13	13	8.5	17	6.5	14.5	10.5	0.014
6	3139 06 00	17	15	10.5	19.5	7	17.5	12.5	0.021
8	3139 08 00	19	18	13.5	24	8	23	15.5	0.032
10	3139 10 00	22	22	16	28	8.5	26	18.5	0.048
12	3139 12 00	24	26	19	33	8.5	31	22.5	0.084
14	3139 14 00	27	29	25.5	37.5	10.5	36	25.5	0.117

The body swivels for positioning purposes.

Boxes protect the contents and are designed to meet your requirements:

- part numbers and corresponding product pictures allow for immediate visual identification
- bar codes
- easy storage
- tamper-proof system of opening/closing
- recyclable material



LF 3000® Push-In Fittings / Multiple Fittings

3144 Equal and Unequal Multiple Y Piece

Technical polymer, NBR

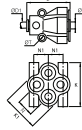

ØD	ØD1		K	K1	L	N	N1	ØT	Kg
4	4	3144 04 04	25.5	21	30.5	10	8.5	3.7	0.015
	6	3144 04 06	25.5	21	30.5	10	8.5	3.7	0.013
6	6	3144 06 06	31.5	26.5	37.5	12	10	3.7	0.032
	8	3144 06 08	31.5	26.5	38	12	10	3.7	0.026

3306 90° Multiple Elbow

Technical polymer, NBR

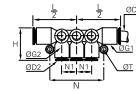

ØD1	ØD2		G	G1	H	L/2	N	N1	ØT	Kg
6	4	3306 06 04	13.5	11	18.5	36	43	11.5	4.2	0.034
8	4	3306 08 04	13.5	11	18.5	36.5	43	11.5	4.2	0.025
	6	3306 08 06	13.5	11	18.5	36.5	43	11.5	4.2	0.022
10	6	3306 10 06	16	13.5	23	42	52	14.5	4.2	0.048
	8	3306 10 08	16	13.5	23.5	42	52	14.5	4.2	0.021

3304 Multiple Tee

Technical polymer, NBR

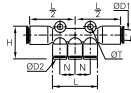

ØD1	ØD2		H	L	L/2	N	ØT	Kg
6	4	3304 06 04	24.5	34	37	11.5	4.2	0.015
8	4	3304 08 04	24.5	34	37	11.5	4.2	0.012
	6	3304 08 06	24.5	34	37	11.5	4.2	0.010
10	6	3304 10 06	36	44	40.5	14.5	4.2	0.019
	8	3304 10 08	36	44	40.5	15.5	4.2	0.015

3310 In-Line Manifold

Treated aluminium, NBR

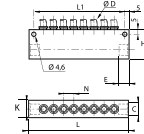

ØD	C		Number of Outlets	E	H	K	L	L1	N	Kg
4	G1/4	3310 04 13	8	10	33	20	114	104	11.5	0.164
6	G1/4	3310 06 13	8	10	33	20	114	104	12.5	0.160
8	G3/8	3310 08 17	6	12	33	20	114	104	15	0.149
10	G1/2	3310 10 21	6	16	48	25	145.5	135.5	17	0.329
12	G1/2	3310 12 21	4	16	45	25	158	148	20.5	0.354

Parker Legris offers the solution to enable many types of configuration options.

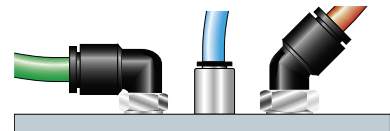

3182 Equal and Unequal Plug-In Elbow

Technical polymer, NBR

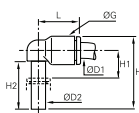

ØD1	ØD2		G	H	H1	H2	L	Kg
4	4	3182 04 00	8.5	23	6	15.5	14	0.005
4	6	3182 04 06	10.5	26.5	7	17	16	0.004
	4	3182 06 04	10.5	24.5	7	15.5	16	0.001
6	6	3182 06 00	10.5	26.5	7	17	16	0.001
	8	3182 06 08	13.5	33.5	8	21.5	23	0.007
8	8	3182 08 00	13.5	33.5	8	21.5	23	0.003
	10	3182 08 10	16	39	10	24.5	26.5	0.010
10	10	3182 10 00	16	39	10	24.5	26.5	0.004
	12	3182 10 12	19	44.5	10.5	27.5	31	0.016
12	12	3182 12 00	19	45.5	10.5	27.5	31	0.007

The references in diameter 4mm and 12mm are not grooved in standard version

3180 45° Plug-In Equal Elbow

Technical polymer, NBR

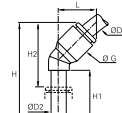

ØD1	ØD2		G	H	H1	H2	L	Kg
4	4	3180 04 00	9	33.5	19	21	13	0.001
6	6	3180 06 00	11	39	21	25	14.5	0.002
8	8	3180 08 00	13.5	44	21.5	25.5	19.5	0.003
10	10	3180 10 00	16	53	27	32.5	23	0.004
12	12	3180 12 00	19	58.5	27.5	34	26.5	0.007

3182 Equal Plug-In Elbow

Inch

Technical polymer, NBR

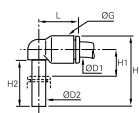

ØD1	ØD2		G	H	H1	H2	L	Kg
1/4	1/4	3182 56 00	11	27.5	7.5	18	18.5	0.002
3/8	3/8	3182 60 00	16	38.5	9	24	26	0.010

5/32"(4 mm) and 5/16"(8 mm) also available

3183 Equal and Unequal Plug-In Run Tee

Technical polymer, NBR

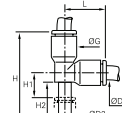

ØD1	ØD2		G	H	H1	H2	L	Kg
4	4	3183 04 00	8.5	33	6	15.5	14.5	0.002
	6	3183 04 06	10.5	38.5	7	17	17.5	0.006
6	6	3183 06 00	10.5	38.5	7	17	17	0.002
	8	3183 06 08	13.5	48.5	8	21.5	23	0.014
8	8	3183 08 00	13.5	49	8	21.5	23	0.004
	10	3183 08 10	16	56.5	10.5	24.5	26.5	0.018
10	10	3183 10 00	16	57	10.5	24.5	26.5	0.007
	12	3183 10 12	19	65.5	10.5	27.5	31	0.034
12	12	3183 12 00	19	65.5	10.5	27.5	31	0.011

3184 Extended Equal and Unequal Plug-In Elbow

Technical polymer, NBR

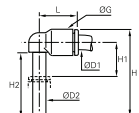

ØD1	ØD2		G	H	H1	H2	L	Kg
4	4	3184 04 00	8.5	32.5	15.5	25	14	0.004
	6	3184 04 06	10.5	38.5	19	29	16	0.004
6	6	3184 06 00	10.5	38.5	19	29	16	0.002
	8	3184 06 08	13.5	49	23.5	37	23	0.007
8	8	3184 08 00	13.5	49	23.5	37	23	0.003
	10	3184 08 10	16	56	26.5	41.5	26.5	0.011
10	10	3184 10 00	16	56	26.5	41.5	26.5	0.005
	12	3184 10 12	19	62.5	28	45.5	31	0.017
12	12	3184 12 00	19	62.5	28	45.5	31	0.008

The references in diameter 4mm and 12mm are not grooved in standard version

3188 Equal and Unequal Plug-In Branch Tee

Technical polymer, NBR

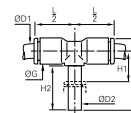

ØD1	ØD2		G	H	H1	H2	L/2	Kg
4	4	3188 04 00	8.5	25	8	15.5	14.5	0.001
	6	3188 04 06	10.5	28.5	9	17	16	0.007
6	6	3188 06 00	10.5	28.5	9	17	16	0.002
	8	3188 06 08	13.5	36.5	11	21.5	22	0.014
8	8	3188 08 00	13.5	36.5	11	21.5	23	0.004
	10	3188 08 10	16	41	12.5	24.5	26.5	0.018
10	10	3188 10 00	16	41	12.5	24.5	26.5	0.007
	12	3188 10 12	19	46.5	12.5	27.5	31	0.030
12	12	3188 12 00	19	46.5	12.5	27.5	31	0.012

3142 Equal and Unequal Plug-In Single Y Piece

Technical polymer, NBR

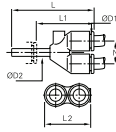

ØD1	ØD2		L	L1	L2	N	Kg
4	4	3142 04 00	34	21.5	17.5	9	0.002
	6	3142 04 06	35.5	21.5	17.5	9	0.002
6	6	3142 06 00	39.5	25.5	21.5	11	0.004
	8	3142 06 08	44.5	26	22	11	0.006
8	8	3142 08 00	50.5	32	28	14.5	0.007
	10	3142 08 10	53.5	32	28	14.5	0.022
10	10	3142 10 00	57.5	36	33	17	0.010
	12	3142 10 12	60	35	33	17	0.035
12	12	3142 12 00	66	41	39	20	0.017

3166 Plug-In Reducer

Technical polymer, NBR

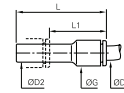

ØD1	ØD2		G	L	L1	Kg
3	4	3166 03 04	8.5	37.5	23.5	0.002
	6	3166 04 06	8.5	37.5	23.5	0.001
4	8	3166 04 08	8.5	37.5	19	0.001
	10	3166 04 10	10.5	38	18	0.003
6	8	3166 06 08	10.5	37.5	20	0.001
	10	3166 06 10	10.5	38	17.5	0.002
8	12	3166 06 12	14.5	46	23	0.005
	14	3166 06 14	14.5	48	23	0.007
10	10	3166 08 10	13.5	49	28.5	0.003
	12	3166 08 12	13.5	49	24.5	0.004
14	14	3166 08 14	17	48	23	0.007
	12	3166 10 12	21.5	56.5	33.5	0.005
10	14	3166 10 14	21.5	58.5	33.5	0.005
	12	3166 12 14	23.5	58.5	33.5	0.007

3143 Multiple Plug-In Y Piece

Technical polymer, Nickel-plated brass, NBR

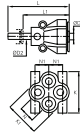

ØD1	ØD2		K	K1	L	L1	N	N1	Kg
4	6	3143 04 06	26	21.5	49.5	35.5	11	8.5	0.018
	8	3143 04 08	26	21.5	51	32	11	8.5	0.021
6	8	3143 06 08	31.5	26.5	57.5	39	12	10	0.035

3166 Plug-In Reducer

Inch

Technical polymer, NBR

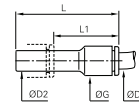

ØD1	ØD2		G	L	L1	Kg
1/4	5/16	3166 56 08	11	41	23	0.002
	3/8	3166 56 60	11	41	21	0.002

3120 Stem Connector

Technical polymer

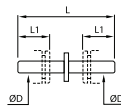

ØD		L	L1	Kg
4	3120 04 00	34.5	12	0.001
6	3120 06 00	38.5	14	0.001
8	3120 08 00	41	18.5	0.001
10	3120 10 00	51.5	20.5	0.002
12	3120 12 00	60	24.5	0.004
14	3120 14 00	69.5	25.5	0.007

3168 Plug-In Increaser

Technical polymer, NBR

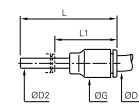

ØD1	ØD2		G	L	L1	Kg
6	4	3168 06 04	10.5	35	23	0.002
	6	3168 08 06	13.5	45	31.5	0.003
8	1/4	3168 08 56	16	40	25.5	0.009
	8	3168 10 08	16	42.5	21	0.004
12	10	3168 12 10	19	49	24.5	0.006

This model exists in nickel-plated brass; please use suffix 85. Example: 3120 06 00 85
Only compatible with Parker Legris fittings. Drawing available upon request.

3168 Plug-In Increaser

Inch

Technical polymer, NBR

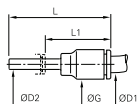

ØD1	ØD2		G	L	L1	Kg
1/4	3/16	3168 56 55	20.5	41	25	0.002
	5/32	3168 56 04	11	41	29	0.002

3126 Blanking Plug

Technical polymer

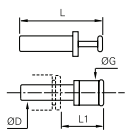

ØD		G	L	L1	Kg
3	3126 03 00	6	25	13.5	0.001
4	3126 04 00	4	30	15.5	0.001
6	3126 06 00	8	33	16.5	0.001
8	3126 08 00	10	35	17.5	0.001
10	3126 10 00	12	42	21	0.002
12	3126 12 00	14	45	22	0.003
14	3126 14 00	16	49	23.5	0.005
16	3126 16 00*	19	57	30	0.064

*Nickel-plated brass

3126 Blanking Plug

Inch

Technical polymer

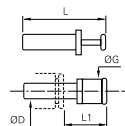

ØD		G	L	L1	Kg
1/4	3126 56 00	8	36.5	22	0.001
3/8	3126 60 00	12	42	22	0.002
1/2	3126 62 00	15	48.5	21.5	0.003

5/32"(4 mm) and 5/16"(8 mm) also available

3122 Plug-In Barb Connector

Technical polymer

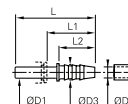

ØD1	ØD2	ØD3		L	L1	L2	Kg
4	3.2	5	3122 04 53	37	25	17	0.004
	5	7	3122 04 05	37	25	17	0.001
6	5	7	3122 06 05	39	25	17	0.001
	6.3	8.5	3122 08 56	39.5	21	17	0.001
8	8	10	3122 08 08	44.5	26	22	0.001
	6.3	8	3122 10 56	45	24.5	17	0.002
10	8	10	3122 10 08	50	29.5	22	0.002
	8	10	3122 12 08	50	26	22	0.002
12	10	12	3122 12 10	48.5	25.5	22.5	0.002
	12.5	14.5	3122 12 62	57	34	22.5	0.004
14	12.5	14.5	3122 14 62	59.5	34.5	22.5	0.006

3151 End Cap

Technical polymer, NBR

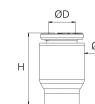

ØD		G	H	Kg
4	3151 04 00	8.5	15	0.001
6	3151 06 00	10.5	17	0.001
8	3151 08 00	13.5	22	0.002
10	3151 10 00	16	22	0.003
12	3151 12 00	19	28	0.005
14	3151 14 00	22	31	0.009

LF 3000® Push-In Fittings / Banjo Fittings



..... A modular solution designed to orientate the tube according to the application.

Ø metric:
4 to 12 mm

Technical Characteristics

- **Compatible Fluids:** Compressed air
Other fluids: please consult us
- **Working Pressure:** Vacuum to 20 bar
- **Working Temperature:** -20°C to +80°C

Tightening Torque (daN.m)	Threads					
	M3 x0.5	M5 x0.8	G1/8	G1/4	G3/8	G1/2
	0.05	0.1	0.4	0.5	0.6	0.7

Reliable performance is dependent upon the type of fluid conveyed, component materials and tubing being used.
Use is guaranteed with a vacuum of 755 mm Hg (99% vacuum).

Advantages

- Screwed from above, for minimum space between connections
- 360° orientable
- Stacking of banjo bodies to allow construction of 2 to 6 outlets

Installation Configurations

Thread and bore diameters for part numbers 3524 - 3527 - 3528 - 3529:

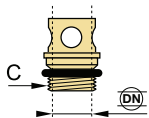

Thread (C)	M5x0.8	G1/8	G1/4	G3/8	G1/2
DN	2.5	5.5	8.5	11	13

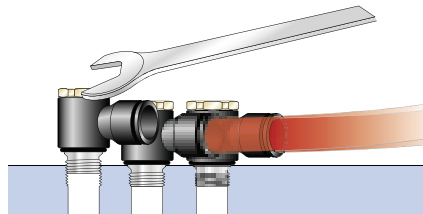

Component Materials

Silicone-free

Bolt: nickel-plated brass, with or without pre-coating, depending on the configuration

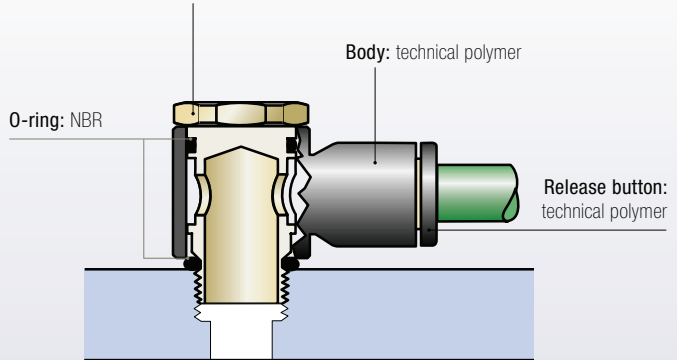

Regulations

- ISO 14743
- PED
- RoHS
- REACH

3118 Single Banjo, Male BSPP and Metric Thread

Technical polymer, Nickel-plated brass, NBR

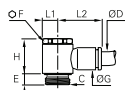

ØD	C		E	F	G	H	L1	L2	Kg
3	M3x0.5	3118 03 09*	3	-	8.5	13	5	16	0.005
	M5x0.8	3118 04 19*	4	-	8.5	13	5	16.5	0.004
4	G1/8	3118 04 10	4	13	8.5	17	7	18.5	0.012
	M5x0.8	3118 06 19*	4	-	10.5	13	7	18.5	0.004
6	G1/8	3118 06 10	4	13	10.5	17	7	20	0.013
	G1/4	3118 06 13	5.5	17	10.5	21	9.5	22	0.023
	G1/8	3118 08 10	4	13	13.5	16.5	7	25	0.014
8	G1/4	3118 08 13	5.5	17	13.5	21	9	27	0.024
	G3/8	3118 08 17	5.5	20	13.5	24.5	11	29	0.038
	G1/4	3118 10 13	5.5	17	16	21	9.5	29	0.025
10	G3/8	3118 10 17	5.5	20	16	24.5	11	31	0.039
	G1/2	3118 10 21	8	25	19	27.5	13.5	36.5	0.083
12	G3/8	3118 12 17	5.5	20	19	24.5	11	34.5	0.040
	G1/2	3118 12 21	8	25	19	27.5	13.5	36.5	0.075

*With screwdriver slot

3018 Single Banjo, Male BSPT Thread

Technical polymer, Nickel-plated brass, NBR

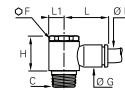

ØD	C		F	G	H	L	L1	Kg
6	R1/8	3018 06 10	13	10.5	18.5	20	7	0.015
	R1/4	3018 06 13	17	10.5	22.5	22	9.5	0.029
8	R1/8	3018 08 10	13	13.5	18.5	25	7	0.016
	R1/4	3018 08 13	17	13.5	22.5	27	9.5	0.030
10	R1/4	3018 10 13	17	16	22.5	29	9.5	0.031
	R3/8	3018 10 17	21	16	26.5	31	11	0.048
12	R1/4	3018 12 13	21	19	26.5	34.5	11	0.052
	R3/8	3018 12 17	21	19	26.5	34.5	11	0.050

Pre-coated thread

LF 3000® Push-In Fittings / Banjo Fittings

3124 Single Banjo, Male/Female BSPP and Metric Thread

Technical polymer, Nickel-plated brass, NBR

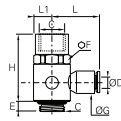

ØD	C		E	F	G	H	L	L1	Kg
4	G1/8	3124 04 10	4	13	8.5	25.5	18.5	7	0.015
6	G1/4	3124 06 13	5.5	17	10.5	33	22	9	0.029
8	G3/8	3124 08 17	5.5	20	13.5	37.5	29	11	0.043

This product family was developed to allow assembly of a function fitting on a cylinder.

3538 Single Banjo Bodies

Technical polymer, NBR

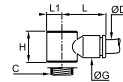

ØD	C		G	H	L	L1	Kg
4	M5x0.8	3538 04 19	8.5	13	16	5	0.001
	G1/8	3538 04 10	10.5	14.5	18.5	7	0.002
6	M5x0.8	3538 06 19	11	13	18.5	5	0.002
	G1/8	3538 06 10	10.5	14.5	20	7	0.002
8	G1/4	3538 08 13	13.5	18	22	9.5	0.003
	G1/8	3538 08 10	13.5	14.5	25	7	0.003
10	G1/4	3538 10 13	16	18	29	9.5	0.005
	G3/8	3538 10 17	16	21.5	31	11.5	0.006
12	G3/8	3538 12 17	19	21.5	34.5	11.5	0.008

3149 Twin Banjo, Male BSPP and Metric Thread

Technical polymer, Nickel-plated brass, NBR

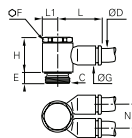

ØD	C		E	F	G	H	L	L1	N	Kg
4	M5x0.8	3149 04 19*	4		8.5	13	16	4.5	9	0.005
	G1/8	3149 04 10	4	13	10.5	16.5	18.5	7	11.5	0.018
6	G1/8	3149 06 10	4	13	10.5	16.5	18.5	7	11.5	0.014
	G1/4	3149 06 13	5.5	17	13.5	21	27	9.5	14.5	0.035
8	G1/4	3149 08 13	5.5	17	13.5	21	27	9.5	14.5	0.026
	G3/8	3149 08 17	5.5	20	16	24.5	31	11	17	0.053
10	G3/8	3149 10 17	5.5	20	16	24.5	31	11	17	0.042

*With screwdriver slot

3539 Double Banjo Bodies

Technical polymer, NBR

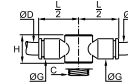

ØD	C		G	H	L/2	Kg
6	G1/8	3539 06 10	10.5	14.3	20	0.011
	G1/4	3539 06 13	13.5	18	26	0.015
8	G1/4	3539 08 13	13.5	18	27	0.005
	G3/8	3539 08 17	16	21.5	30.5	0.020
10	G3/8	3539 10 17	16	21.5	31	0.008

3119 Double Banjo, BSPP and Metric Thread

Technical polymer, Nickel-plated brass, NBR

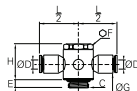

ØD	C		E	F	G	H	L/2	Kg
4	M5x0.8	3119 04 19*	4		8.5	13	8	0.005
6	G1/8	3119 06 10	4	13	11	17	20	0.014
	G1/4	3119 06 13	5.5	17	13.5	21	26.5	0.035
8	G1/4	3119 08 13	5.5	17	13.5	21	27	0.026
	G3/8	3119 08 17	5.5	20	16	24.5	30.5	0.053

*With screwdriver slot

3549 Twin Banjo Bodies

Technical polymer, NBR

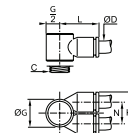

ØD	C		G	K	L	N	Kg
4	M5x0.8	3549 04 19	10	17.5	15.5	9	0.003
	G1/4	3549 04 13	18.5	28	25	14.5	0.020
6	G1/8	3549 06 10	14	22.5	20.5	12	0.003
	G1/4	3549 06 13	18.5	28	25	14.5	0.015
8	G3/8	3549 06 17	22.5	33	28.5	17	0.031
	G1/4	3549 08 13	18.5	28	26	14.5	0.006
10	G3/8	3549 08 17	22.5	33	29.5	17	0.020
	G3/8	3549 10 17	22.5	33	29.5	17	0.009

LF 3000® Push-In Fittings / Modular Banjo Fittings

3527 Single Banjo Bolts, Male BSPP and Metric Thread

Nickel-plated brass, NBR

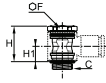

C		F	H	H1	Kg	
M5x0.8	3527 00 19*		17	7.5	0.003	
G1/8	3527 00 10		13	17	7.5	0.011
G1/4	3527 00 13		17	21	9.5	0.020
G3/8	3527 00 17		20	24.5	11	0.033

*With screwdriver slot
Full bore

3529 Stacking Banjo for 3 Body High Modules, Male BSPP Thread

Nickel-plated brass, NBR

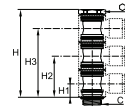

C		F	H	H1	H2	H3	Kg	
G1/8	3529 00 10		13	45.5	7.5	22	36	0.023
G1/4	3529 00 13		17	54	9.5	27.5	45.5	0.042
G3/8	3529 00 17		20	67.5	11	32.5	54	0.069

Full bore
Designed for use with 3 banjo bodies

3528 Stacking Banjo for 2 Body High Modules, Male BSPP and Metric Thread

Nickel-plated brass, NBR

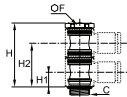

C		F	H	H1	H2	Kg	
M5x0.8	3528 00 19*		24.5	7.5	18.5	0.005	
G1/8	3528 00 10		13	31	7.5	22	0.017
G1/4	3528 00 13		17	39	9.5	27.5	0.031
G3/8	3528 00 17		20	46	11	32.5	0.053

*With screwdriver slot
Full bore
Designed for use with 2 banjo bodies

3524 Threaded Banjo Bolts, Male/Female BSPP and Metric Thread

Nickel-plated brass, NBR

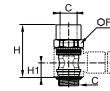

C		F	H	H1	Kg	
G1/8	3524 00 10		13	24.5	7.5	0.013
G1/4	3524 00 13		17	33	9.5	0.027
G3/8	3524 00 17		20	37.5	11	0.039
G1/2	3524 00 21		26	42	11.5	0.067

Full bore

Banjo bolts 3527, 3528, 3529 and 3524 are only usable in association with the corresponding bodies for modular construction 3538, 3539 and 3549.

Thread and passage size for part numbers 3527, 3528, 3529 and 3524.

Thread	M5x0.8	G1/8	G1/4	G3/8	G1/2
	2.5	5.5	8.5	11	13

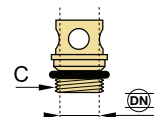

LF 3000® Push-In Fittings / Modular Plug-In Connectors

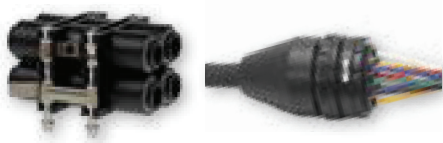

These connectors secure and facilitate the connection of several circuits by mechanical coding.

Ø metric:
4 to 8 mm

Technical Characteristics

- **Compatible Fluids:** Compressed air
Other fluids: please consult us
- **Working Pressure:** Vacuum to 10 bar
- **Working Temperature:** -20°C to +80°C

Reliable performance is dependent upon the type of fluid conveyed, component materials and tubing being used.

Use is guaranteed with a vacuum of 755 mm Hg (99% vacuum).

Advantages

- 3 types of solutions: in-line, panel-mounted or DIN rail connector
- Minimized connection space
- Prevents incorrect assembly
- Customised multi-connectors upon request

Component Materials

Silicone-free

- Multi-connectors:**
- panel-mounted: zinc-plated steel, technical polymer
 - in-line: aluminium, technical polymer
 - DIN rail: technical polymer

Connections: LF 3000®



Regulations

- ISO 14743
- PED
- RoHS
- REACH

Installations Configurations

Panel-Mounted

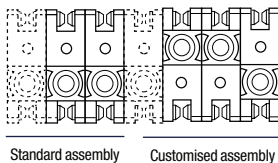

Standard assembly Customised assembly

A box contains:

- 10 units
- 20 joining clips and 4 end pins
- 4 mounting brackets
- 4 coupling clips
- 1 dismantling tool

In-Line



DIN Rail Connector

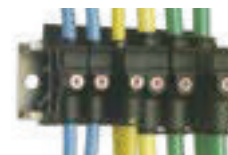

The module is constructed from a number of symmetrical components connected by joining clips. A coupling clip locks the module closed. A dismantling tool allows disconnection.

Maximum 5 modules recommended for the mating module; the fixed module is not limited.

3300 Modular Plug-In Connector

Technical polymer, NBR

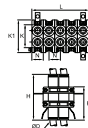

ØD		B	H	H1	K	K1	L	L1	L2	N	Kg
4	3300 04 00	21	40.5	29.5	32	20	55	22	6	11	0.079
6	3300 06 00	28	48	38.5	39	27.5	70	28	7.5	14	0.213
8	3300 08 00	28	50	39	39	27.5	70	28	7.5	14	0.125

Clearance hole for Ø3 mm screw

3320 Multi-Connector Male Screw Body

Technical polymer, NBR

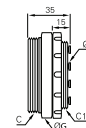

ØD	C	C1		Number of Outlets	G	Kg
	M46x1.5	M40x1.5	3320 04 00 04	4	50	0.069
4	M46x1.5	M40x1.5	3320 04 00 07	7	50	0.071
	M65x1.5	M58x1.5	3320 04 00 12	12	70	0.137
	M46x1.5	M40x1.5	3320 06 00 04	4	50	0.070
6	M46x1.5	M40x1.5	3320 06 00 07	7	50	0.073

The number of male body outlets must correspond to the same number of outlets on the female body.

3321 Multi-Connector Female Screw Body

Technical polymer, NBR

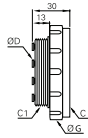

ØD	C	C1		Number of Outlets	G	Kg
4	M46x1.5	M40x1.5		3321 04 00 04	4	55 0.065
	M46x1.5	M40x1.5		3321 04 00 07	7	55 0.063
	M65x1.5	M58x1.5		3321 04 00 12	12	75 0.125
6	M46x1.5	M40x1.5		3321 06 00 04	4	55 0.065
	M46x1.5	M40x1.5		3321 06 00 07	7	55 0.064

The number of female body outlets must correspond to the same number of outlets on the male body.

3329 Multi-Connector Screw Cap

Technical polymer

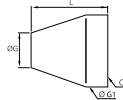

C		Number of Outlets	G	G1	L	Kg
M40x1.5		3329 00 02	4-7	35	50	55 0.062
M58x1.5		3329 00 03	12	34	70	70 0.139

3379 DIN Rail Connector for 2 Tubes

Technical polymer, NBR

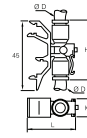

ØD		H	K	L	Kg
4		3379 04 00	34.5	11	39.5 0.010
6		3379 06 00	34.5	11	39.5 0.006
8		3379 08 00	46	13	44.5 0.008

Start pressure test point on the system

3381 DIN Rail Connector for 3 Tubes

Technical polymer, NBR

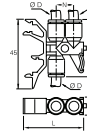

ØD		H	K	L	N	Kg
4		3381 04 00	36.5	11	39.5	11.5 0.013
6		3381 06 00	36.5	11	39.5	11.5 0.007
8		3381 08 00	46	13	44.5	14.5 0.033

Start pressure test point on the system

Overall Dimensions for Bulkhead Mounting

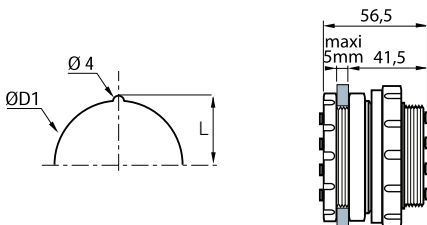

Number of Outlets	L	ØD1
2	17	32.5
4-7	21	40.5
12	30.3	58.5

LF 3000® Push-In Fittings / Self-Sealing and Oscillating Fittings



2 functions available for quick machine intervention and to facilitate the operation of the installations.

Ø metric:
4 to 12 mm

Technical Characteristics

- **Compatible Fluids:** Compressed air
Other fluids: please consult us
- **Working Pressure:** Vacuum to 20 bar
(10 bar: self-sealing fitting)
- **Working Temperature:** -20°C to +80°C

Reliable performance is dependent upon the type of fluid conveyed, component materials and tubing being used.

Use is guaranteed with a vacuum of 755 mm Hg (99% vacuum).

Advantages

- **Self-Sealing Fittings**
 - Prevents fluid flow when there is no tube connected
 - When connected, the compressed air flow is restored
- **Oscillating Fittings**
 - Fitting swivels when cylinder is in movement : no bending of the tube
 - High durability of the fitting/tube assembly

Component Materials

Swivel Fitting

- Body:
- Self-sealing fitting: nickel-plated brass
 - Oscillating fitting: technical polymer

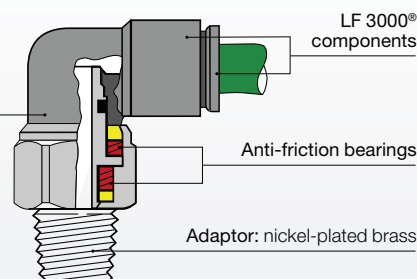

Silicone-free

Regulations

- ISO 14743
- PED
- RoHS
- REACH

Installation Configurations

Self-Sealing Fitting

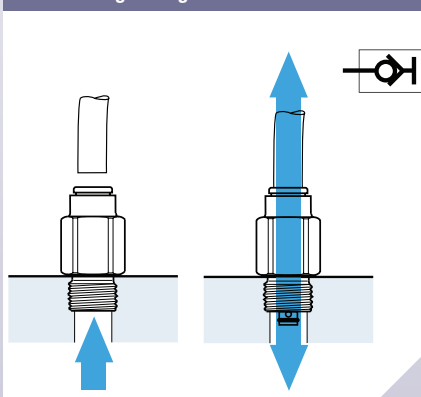

Oscillating Fitting

Tube O.D. (mm)	Torque (daN.m)	Max. Rotation Speed (turn/min.)
4	$2.5 \cdot 10^{-3}$	190
6	$4 \cdot 10^{-3}$	160
8	$7 \cdot 10^{-3}$	120
10	$11 \cdot 10^{-3}$	90
12	$16 \cdot 10^{-3}$	80

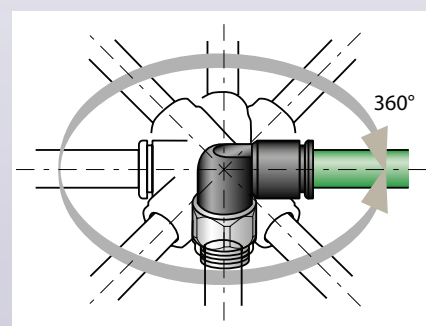

3391 Self-Sealing Stud Fitting, Male BSPP Thread

Nickel-plated brass, NBR

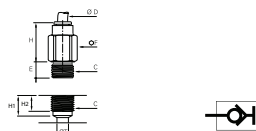

ØD	C		E	F	H	H1	H2	ØT	Kg
4	G1/8	3391 04 10	5	13	18	7.5	6	5	0.017
6	G1/8	3391 06 10	5	14	19.5	9	6	7.5	0.018
8	G1/8	3391 08 10	5	14	29.5	10	6	7.5	0.025
	G1/4	3391 08 13	5.5	16	25.5	11	8	9	0.032
10	G3/8	3391 10 17	5.5	20	27.5	13	11	10	0.055

Maximum working pressure: 10 bar

3091 Self-Sealing Stud Fitting, Male BSPT Thread

Nickel-plated brass, NBR

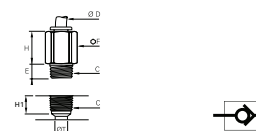

ØD	C		E	F	H	H1	ØT	Kg
4	R1/8	3091 04 10	7.5	12	18	9.5	5	0.014
6	R1/8	3091 06 10	7.5	13	19.5	9.5	7.5	0.015
8	R1/8	3091 08 10	6.5	14	25	10.5	7.5	0.024
	R1/4	3091 08 13	11	14	25.5	13.5	9	0.021

Maximum working pressure: 10 bar

3160 Self-Sealing Plug-In Fitting

Technical polymer, NBR

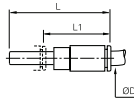

ØD		L	L1	Kg
4	3160 04 00	46	33.5	0.006
6	3160 06 00	53.5	31	0.009
8	3160 08 00	58	31	0.014

3159 Oscillating Elbow, Male BSPT Thread

Technical polymer, Nickel-plated brass, NBR

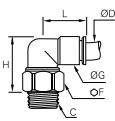

ØD	C		F	G	H	L	Kg
4	R1/8	3159 04 10	12	11	22	17.5	0.013
6	R1/8	3159 06 10	14	14	26.5	20.5	0.020
	R1/4	3159 06 13	14	14	23.5	20.5	0.022
8	R1/8	3159 08 10	17	16	32	23.5	0.034
	R1/4	3159 08 13	17	16	29	23.5	0.034
10	R3/8	3159 08 17	17	16	25	23.5	0.031
	R1/4	3159 10 13	19	19.5	37.5	29	0.051
12	R3/8	3159 10 17	19	19.5	33.5	29	0.046
	R1/4	3159 12 13	21	22	44.5	33.5	0.074
	R3/8	3159 12 17	21	22	41	33.5	0.068

Pre-coated thread

3189 Oscillating Elbow, Male BSPP and Metric Thread

Technical polymer, Nickel-plated brass, NBR

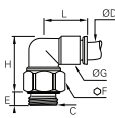

ØD	C		E	F	G	H	L	Kg
4	M5x0.8	3189 04 19	3	12	11	24.5	17.5	0.012
	G1/8	3189 04 10	5	13	11	23	17.5	0.014
6	M5x0.8	3189 06 19	3	12	14	27.5	20.5	0.017
	G1/8	3189 06 10	5	14	14	27	20.5	0.019
8	G1/4	3189 06 13	5.5	16	14	25.5	20.5	0.023
	G1/8	3189 08 10	5	17	16	33.5	23.5	0.034
10	G1/4	3189 08 13	5.5	17	16	31	23.5	0.032
	G3/8	3189 08 17	5.5	20	16	29.5	23.5	0.039
12	G1/4	3189 10 13	5.5	19	19.5	39	29	0.053
	G3/8	3189 10 17	5.5	20	19.5	37	29	0.051
12	G1/4	3189 12 13	5.5	21	22	46.5	33.5	0.073
	G3/8	3189 12 17	5.5	21	22	45.5	33.5	0.071

LF 3000® Push-In Fittings / Maintenance Kit



The essential tool to rapidly carry out the main maintenance operations and reduce production interruptions.

Advantages

- 2 kits available: for BSPP products and BSPT products
- A selection of 24 references covering the most-used products
- Products available in the most common diameters: 4 mm, 6 mm and 8 mm
- A kit contains more than 300 products and can be easily completed with our standard products

Part Numbers Common to Both Kits

ØD	Part Numbers	Qty	ØD	Part Numbers	Qty	
4	3104 04 00	10	4	3106 04 00	10	
6	3104 06 00	10	6	3106 06 00	10	
8	3104 08 00	10	8	3106 08 00	10	
ØD1	ØD2	Part Numbers	Qty	ØD	Part Numbers	Qty
4	6	3166 04 06	10	6	3102 06 00	10
6	8	3166 06 08	10	8	3102 08 00	10
ØD	Part Numbers	Qty	3000 71 00	1		
4	3126 04 00	20	0605 12 12	1		
6	3126 06 00	20				
8	3126 08 00	20				



ADDITIONAL PART NUMBERS IN BSPP KIT

ØD	C	Part Numbers	Qty
4	G1/8	3101 04 10	20
6	M5x0.8	3101 06 19	20
6	G1/8	3101 06 10	20
6	G1/4	3101 06 13	20
8	G1/4	3101 08 13	20
4	M5x0.8	3199 04 19	10
4	G1/8	3199 04 10	10
6	M5x0.8	3199 06 19	10
6	G1/8	3199 06 10	10
6	G1/4	3199 06 13	10
8	G1/4	3199 08 13	10

ADDITIONAL PART NUMBERS IN BSPT KIT

ØD	C	Part Numbers	Qty
4	R1/8	3175 04 10	20
4	R1/4	3175 04 13	20
6	R1/8	3175 06 10	20
6	R1/4	3175 06 13	20
8	R1/4	3175 08 13	20
4	R1/8	3109 04 10	10
6	R1/8	3109 06 10	10
6	R1/4	3109 06 13	10
8	R1/8	3109 08 10	10
8	R1/4	3109 08 13	10

3150..57 Maintenance kit, BSPP Thread



3150 00 01 57UN

H L L1 Kg
81 413 330 3,221

3150..58 Maintenance kit, BSPT Thread



3150 00 01 58UN

H L L1 Kg
81 413 330 3,750

LF 3200 Push-In Fittings (3 mm)



A miniaturized and ergonomic range that maintains high mechanical characteristics.

Ø metric:
3 mm

Technical Characteristics

- **Compatible Fluids:** Compressed air
- **Working Pressure:** Vacuum to 20 bar
- **Working Temperature:** -15°C to +80°C
- **Tightening Torque (daN.m):** 0.01 to 0.1

Reliable performance is dependent upon the type of fluid conveyed, component materials and tubing being used.

Use is guaranteed with a vacuum of 755 mm Hg (99% vacuum).

Advantages

- Optimization of equipment: weight, small dimensions
- Nickel-plated brass components for better impact and corrosion resistance
- Working pressures: from vacuum to 20 bar

Component Materials

Silicone-free



Regulations

- ISO 14743
- PED
- RoHS
- ATEX (please consult us)
- REACH

3281 Stud Fitting, Male Metric Thread

Nickel-plated brass, NBR



ØD	C		F	G	H	Kg
3	M3x0.5	3281 03 09	1.5	6	9.5	0.001
	M5x0.8	3281 03 19	1.5	8	9.5	0.002

3229 Extended Stud Elbow, Male Metric Thread

Nickel-plated brass, NBR

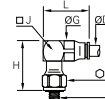

ØD	C		F	G	H	J	L	Kg
3	M3x0.5	3229 03 09	6	6	16	6	13.5	0.004
	M5x0.8	3229 03 19	8	6	17	6	13.5	0.005

3299 Compact Stud Elbow, Male Metric Thread

Nickel-plated brass, NBR

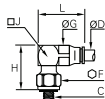

ØD	C		F	G	H	J	L	Kg
3	M3x0.5	3299 03 09	6	6	13.5	6	13.5	0.004
	M5x0.8	3299 03 19	8	6	13	6	13.5	0.005

3298 Stud Branch Tee, Male Metric Thread

Nickel-plated brass, NBR

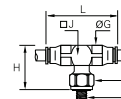

ØD	C		F	G	H	J	L	Kg
3	M3x0.5	3298 03 09	6	6	13.5	6	20.5	0.004
	M5x0.8	3298 03 19	8	6	13	6	20.5	0.005

LF 3200 Push-In Fittings (3 mm)

3293 Stud Run Tee, Male Metric Thread

Nickel-plated brass, NBR

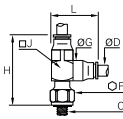

ØD	C		F	G	H	J	L	Kg
3	M3x0.5	3293 03 09	6	6	20	6	13.5	0.004
	M5x0.8	3293 03 19	8	6	20	6	13.5	0.005

3204 Equal Tee

Nickel-plated brass, NBR

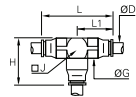

ØD			G	H	J	L	L1	Kg
3	3204 03 00		6	13.5	6	20.5	10.5	0.004

3218 Single Banjo, Male Metric Thread

Nickel-plated brass, NBR

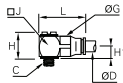

ØD	C		G	H	H1	J	L	Kg
3	M3x0.5	3218 03 09	6	9.5	4	6	12.5	0.002
	M5x0.8	3218 03 19	6	10.5	4.5	8	15	0.005

3266 Plug-In Reducer

Nickel-plated brass, NBR, technical polymer

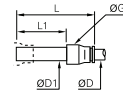

ØD	ØD1		G	L	L1	Kg
3	4	3266 03 04	6	28	19	0.001

3206 Equal Tube/Tube Connector

Nickel-plated brass, NBR



ØD			G	L	Kg
3	3206 03 00		6	17	0.002

3226 Blanking Plug

Nickel-plated brass

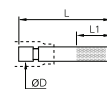

ØD			L	L1	Kg
3	3226 03 00		20	10	0.004

3202 Equal Elbow

Nickel-plated brass, NBR

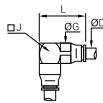

ØD			G	J	L	Kg
3	3202 03 00		6	6	13.5	0.003

Installation Configurations



The LF 3200 fitting, connected with a 3 mm polyurethane or antistatic polyurethane tube, is the perfect solution for compact installations:

- which are highly stressed
- whose reliability is critical



LIQUIfit® Push-in Fittings / Stud Fittings

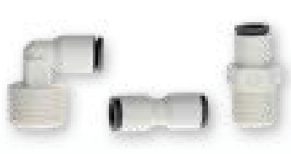

Innovative and compact connectors for the transfer of fluids and liquids.

Ø metric: 4 to 16 mm
Ø inch: 1/4" to 1/2"

Technical Characteristics

- **Compatible Fluids:** Water, beverages, CO₂ (inert use)
Chemical fluids: please consult us
- **Working Pressure:** Vacuum to 16 bar
- **Working Temperature:**
-10°C to +130°C (up to 10 bar) for 4, 6, 8 mm O.D. tube-to-tube fittings
-10°C to +95°C for all other products

Tightening Torques (BSPT/NPTF)	Thread	1/8" and 1/4"	3/8" and 1/2"
	daN.m		0.15

Reliable performance is dependent upon the type of fluid conveyed, component materials and tubing being used.

Use is guaranteed with a vacuum of 755 mm Hg (99% vacuum).

Advantages

- Bio-sourced polymer meeting food process regulations
- Compliant with FDA, NSF, DM174, WRAS, KTW, ACS standards
- Easy-to-clean external surfaces
- Free of bisphenol and phthalates

Component Materials

Silicone-free

Grey release button: technical polymer

Body and adaptor: bio-based polymer

Seal: EPDM

Gripping ring or collet (6501 and 6599): stainless steel



Regulations

- RoHS
- REACH
- FDA: 21 CFR
- NSF: 51
- NSF 61 - C HOT
- 1935/2004
- DM 174
- ACS
- WRAS
- KTW
- W270

Pressure and Temperature of the Different Diameters and Related Products of the LIQUIfit® Range

-10°C		Pressure (bar)	
mm Ø	inch Ø	Fittings	PE Tubing
4	5/32	16	16
6	1/4	16	16
8	5/16	16	16
10	3/8	13	15
12	1/2	11	11

+1°C		Pressure (bar)	
mm Ø	inch Ø	Fittings	PE Tubing
4	5/32	16	16
6	1/4	16	16
8	5/16	16	16
10	3/8	13	15
12	1/2	11	11

+20°C		Pressure (bar)	
mm Ø	inch Ø	Fittings	PE Tubing
4	5/32	16	16
6	1/4	16	16
8	5/16	16	16
10	3/8	13	15
12	1/2	11	11

+40°C		Pressure (bar)	
mm Ø	inch Ø	Fittings	PE Tubing
4	5/32	16	16
6	1/4	16	16
8	5/16	16	16
10	3/8	13	15
12	1/2	11	11

+65°C		Pressure (bar)	
mm Ø	inch Ø	Fittings	PE Tubing
4	5/32	12	10
6	1/4	12	10
8	5/16	12	10
10	3/8	7	7
12	1/2	7	7

+95°C		Pressure (bar)	
mm Ø	inch Ø	Fittings	PE Tubing
4	5/32	12	4
6	1/4	12	4
8	5/16	12	4
10	3/8	4	4
12	1/2	4	4

6501 Stud Fitting, Male BSPP Thread

POM, EPDM



ØD	C		E	F	G	H	Kg
6	G1/8	6501 06 10WP2	6	15	18	18	0.003
	G1/4	6501 06 13WP2	8.5	18	18	15.5	0.004
8	G1/8	6501 08 10WP2	6	17	18	18.5	0.005
	G1/4	6501 08 13WP2	8.5	18	18	20	0.006
	G3/8	6501 08 17WP2	6	21	20	17.5	0.007
	G1/4	6501 10 13WP2	8.5	19	20	22	0.007
10	G3/8	6501 10 17WP2	9	21	20	17	0.007
	G1/2	6501 10 21WP2	12.5	26	21.5	17	0.011
12	G3/8	6501 12 17WP2	9	24	21.5	25	0.011
	G1/2	6501 12 21WP2	12.5	26	21.5	20	0.012

Collet technology

6505 Stud Fitting, Male BSPT Thread

Bio-based polymer, EPDM

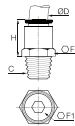

ØD	C		F	F1	H	Kg
4	R1/8	6505 04 10WP2	11	3	18	0.003
	R1/4	6505 04 13WP2	14	3	18	0.004
6	R1/8	6505 06 10WP2	11	4	18	0.002
	R1/4	6505 06 13WP2	14	4	18	0.004
8	R1/8	6505 08 10WP2	17	6	20	0.004
	R1/4	6505 08 13WP2	14	6	20	0.004
	R3/8	6505 08 17WP2	17	6	20	0.005
10	R1/4	6505 10 13WP2	17	7	21.5	0.005
	R3/8	6505 10 17WP2	19	7	21.5	0.007
12	R1/2	6505 10 21WP2	22	7	21.5	0.010
	R3/8	6505 12 17WP2	19	9	24.5	0.008
	R1/2	6505 12 21WP2	22	9	24.5	0.012

6505 Stud Fitting, Male NPTF Thread

Inch

Bio-based polymer, EPDM

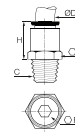

ØD	C		F	F1	H	Kg
1/4	NPT1/8	6505 56 11WP2	12	532	17	0.002
	NPT1/4	6505 56 14WP2	9/16	532	17	0.003
3/8	NPT1/4	6505 60 14WP2	34	14	22	0.006
	NPT3/8	6505 60 18WP2	34	14	22	0.007
1/2	NPT3/8	6505 62 18WP2	15/16	38	28	0.012
	NPT1/2	6505 62 22WP2	15/16	38	28	0.013

Thread without pre-coating

6505 Stud Fitting, Male BSPT Thread

Inch

Bio-based polymer, EPDM

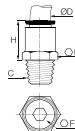

ØD	C		F	F1	H	Kg
1/4	R1/8	6505 56 10WP2	11	5	17	0.002
	R1/4	6505 56 13WP2	14	5	17	0.003
3/8	R3/8	6505 60 17WP2	19	7	22	0.006
	R1/2	6505 60 21WP2	22	7	28	0.012
1/2	R1/2	6505 62 21WP2	24	9	28	0.017

5/32" (4mm) and 5/16" (8mm) are available
Thread without pre-coating

6315 Stud Connector, Female BSPT Thread

Bio-based polymer, EPDM

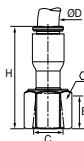

ØD	C		E	F	H	Kg
6	R1/8	6315 06 10WP2	11	13	32	0.003
	R1/4	6315 06 13WP2	14	16	33	0.004
8	R1/4	6315 08 13WP2	14	16	33.5	0.004
	R3/8	6315 08 17WP2	14	20	36	0.009

WP3 = high volumes (number of parts per bag: 40, 50 or 100, depending on the diameters).

6315 Stud Fitting, Female NPTF Thread

Inch

Bio-based polymer, EPDM

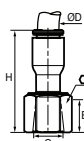

ØD	C		F	H	Kg
1/4	NPT1/4	6315 56 14WP2	11/16	30	0.003
3/8	NPT3/8	6315 60 18WP2	13/16	36	0.007

6352 Stud Fitting Flat Type, Female BSPP Thread Inch

Bio-based polymer, EPDM

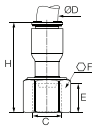

ØD	C		E	F	H	Kg
3/8	G3/8	6352 60 17WP2	12	22	36	0.008
	G1/2	6352 60 21WP2	12	27	36	0.011

6325 Faucet Connector, Female UNS Thread Inch

Bio-based polymer, EPDM

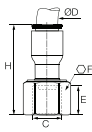

ØD	C		E	F	H	Kg
1/4	UNS7/16-24	6325 56 133WP2	7	9/16	31	0.002

6521 Stud Standpipe, Male BSPT Thread

Bio-based polymer

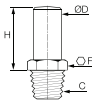

ØD	C		F	H	Kg
6	R1/8	6521 06 10WP2	13	19	0.002
	R1/4	6521 06 13WP2	14	19	0.003
	R3/8	6521 06 17WP2	17	19	0.004
8	R1/8	6521 08 10WP2	19	23	0.003
	R1/4	6521 08 13WP2	19	23	0.004
	R3/8	6521 08 17WP2	19	23	0.004
10	R1/4	6521 10 13WP2	19	25	0.004
	R3/8	6521 10 17WP2	19	25	0.005
	R1/2	6521 10 21WP2	22	25	0.008
12	R3/8	6521 12 17WP2	22	28	0.005
	R1/2	6521 12 21WP2	22	28	0.007

Thread without pre-coating.

6521 Stud Standpipe, Male NPTF Thread Inch

Bio-based polymer

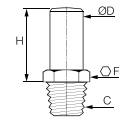

ØD	C		F	H	Kg
3/8	NPT1/4	6521 60 14WP2	3/4	25	0.004
	NPT3/8	6521 60 18WP2	3/4	25	0.004

Thread without pre-coating.

6521 Stud Standpipe, Male BSPT Thread Inch

Bio-based polymer

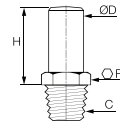

ØD	C		F	H	Kg
1/4	R1/8	6521 56 10WP2	14	19	0.002
	R1/4	6521 56 13WP2	14	19	0.002
	R3/8	6521 56 17WP2	17	19	0.004
3/8	R3/8	6521 60 17WP2	19	25	0.004

Thread without pre-coating.
5/16" (8mm) also available.

6300 LIQUIfit® Cartridge

Brass, EPDM

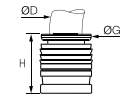

ØD		G	G1	H	L	Kg
4	6300 04 00	8	11	10	554	0.002
6	6300 06 00	10	14.5	11.5	629	0.002
8	6300 08 00	13	15	15	794	0.003
10	6300 10 00	15.5	19.5	17	930	0.005
12	6300 12 00	18.5	21	19.5	1038	0.010

50 cartridges per Carstick®

Please consult us for detailed drawings of cavity dimensions and tolerances

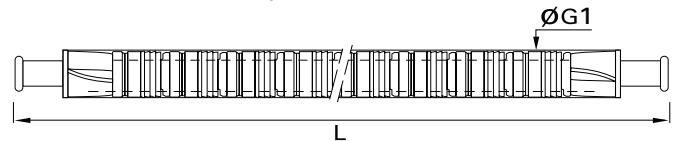

Sealing Profile for Female Thread Stud Fitting

Stud Fitting,
Female NPTF Thread
6315

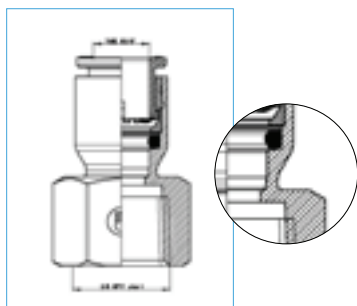

Stud Fitting Flat Type,
Female BSPP Thread,
6352

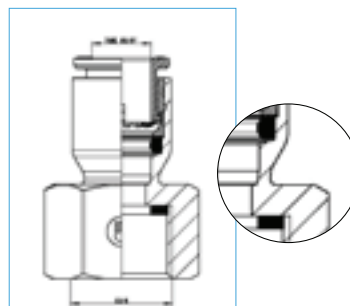

6300 LIQUIfit® Cartridge

Inch

Brass, EPDM

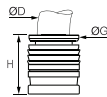

ØD		G	G1	H	L	Kg
1/4	6300 56 00	10.5	14.5	12.5	600	0.002
3/8	6300 60 00	15.5	19	17	930	0.005
1/2	6300 62 00	22	25	23	1038	0.011

50 cartridges per Carstick®
5/32" (4 mm) and 5/16" (8 mm) also available.
Please consult us for detailed drawings of cavity dimensions and tolerances

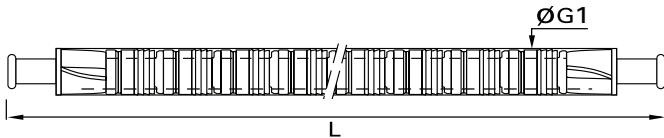

6579 Fixed Elbow, Male BSPT Thread

Bio-based polymer, EPDM

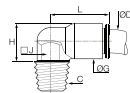

ØD	C		G	H	J	L	Kg
6	R1/8	6579 06 10WP2	11	14	10	19	0.002
	R1/4	6579 06 13WP2	11	14	10	19	0.003
	R3/8	6579 06 17WP2	11	14	10	19	0.004

Thread without pre-coating.

6579 Fixed Elbow, Male NPTF Thread

Inch

Bio-based polymer, EPDM

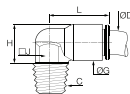

ØD	C		G	H	J	L	Kg
1/4	NPT1/8	6579 56 11WP2	11	22	38	18	0.009
	NPT1/4	6579 56 14WP2	11	26	38	18	0.003
3/8	NPT1/4	6579 60 14WP2	16	32	12	26	0.006

Thread without pre-coating.

6579 Fixed Elbow, Male BSPT Thread

Inch

Bio-based polymer, EPDM

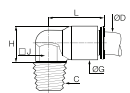

ØD	C		G	H	J	L	Kg
1/4	R1/4	6579 56 13WP2	11	26	10	18	0.003
3/8	R3/8	6579 60 17WP2	16	32	13	26	0.006

Thread without pre-coating.

6599 Stud Elbow, Male BSPP Thread

POM, EPDM



ØD	C		E	F	G	H	Kg
6	G1/8	6599 06 10WP2	6	17	15	24.5	0.007
	G1/4	6599 06 13WP2	8.5	18	15	33	0.008
	G1/8	6599 08 10WP2	6	18	17.5	26	0.010
8	G1/4	6599 08 13WP2	8.5	18	17.5	26	0.011
	G3/8	6599 08 17WP2	9	22	17.5	26	0.012
	G1/4	6599 10 13WP2	8.5	22	20	29.5	0.015
10	G3/8	6599 10 17WP2	9	22	20	29.5	0.015
	G1/2	6599 10 21WP2	12.5	26	20	29.5	0.019
	G3/8	6599 12 17WP2	9	26	23	34.5	0.023
12	G1/2	6599 12 21WP2	12.5	26	23	34.5	0.025

Collet technology

Thread without pre-coating; the body swivels for positioning purposes.

6509 Stud Elbow, Male BSPT Thread

Bio-based polymer, EPDM

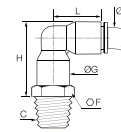

ØD	C		F	G	H	L	Kg
6	R1/8	6509 06 10WP2	13	10.5	28	24	0.037
	R1/4	6509 06 13WP2	14	10.5	28	24	0.007
	R3/8	6509 06 17WP2	17	10.5	28	24	0.008
8	R1/8	6509 08 10WP2	19	13.5	34	29.5	0.010
	R1/4	6509 08 13WP2	19	13.5	34	29.5	0.011
	R3/8	6509 08 17WP2	19	13.5	34	29.5	0.011
10	R1/4	6509 10 13WP2	19	16	38	34.5	0.019
	R3/8	6509 10 17WP2	19	16	38	34.5	0.020
	R1/2	6509 10 21WP2	22	16	38	34.5	0.023
12	R3/8	6509 12 17WP2	22	19	44	40	0.022
	R1/2	6509 12 21WP2	22	19	44	40	0.024

Thread without pre-coating; the body swivels for positioning purposes.

6509 Stud Elbow, Male NPTF Thread

Inch

Bio-based polymer, EPDM

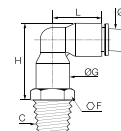

ØD	C		F	G	H	L	Kg
1/4	NPT1/8	6509 56 11WP2	1/2	11	28	23.5	0.003
	NPT1/4	6509 56 14WP2	9/16	11	28	23.5	0.004
	NPT3/8	6509 56 18WP2	3/4	11	28.5	23.5	0.006

Thread without pre-coating, the body swivels for positioning purposes.

6509 Stud Elbow, Male BSPT Thread

Inch

Bio-based polymer, EPDM

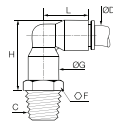

ØD	C		F	G	H	L	Kg
1/2	R1/2	6509 62 21WP2	24	22	50.5	46.5	0.027

5/16" (8 mm) also available.

Thread without pre-coating, the body swivels for positioning purposes.

6508 Branch Tee, Male BSPT Thread

Bio-based polymer, EPDM

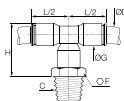

ØD	C		F	G	H	L/2	Kg
6	R1/8	6508 06 10WP2	13	10.5	28	18	0.008
	R1/4	6508 06 13WP2	14	10.5	28	18	0.009
	R3/8	6508 06 17WP2	17	10.5	28	18	0.010
8	R1/8	6508 08 10WP2	19	13.5	34	23	0.012
	R1/4	6508 08 13WP2	19	13.5	34	23	0.013
	R3/8	6508 08 17WP2	19	13.5	34	23	0.013
10	R1/4	6508 10 13WP2	19	16	38	26.5	0.018
	R3/8	6508 10 17WP2	19	16	38	26.5	0.019
	R1/2	6508 10 21WP2	22	16	38	26.5	0.022
12	R1/2	6508 12 21WP2	22	19	44	31	0.026

Thread without pre-coating, the body swivels for positioning purposes.

6503 Run Tee, Male BSPT Thread

Bio-based polymer, EPDM

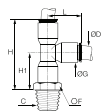

ØD	C		F	G	H	H1	L	Kg
6	R1/4	6503 06 13WP2	14	10.5	40	22	18.5	0.009
	R1/8	6503 08 10WP2	19	13.5	50	27	23	0.012
8	R1/4	6503 08 13WP2	19	13.5	50	27	23	0.013
	R3/8	6503 08 17WP2	19	13.5	50	27	23	0.013
12	R3/8	6503 12 17WP2	22	19	65.5	34.5	31	0.024
	R1/2	6503 12 21WP2	22	19	65.5	34.5	31	0.026

Thread without pre-coating, the body swivels for positioning purposes.

6355 Unequal Connector, Female BSPP Thread

Bio-based polymer, EPDM

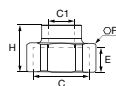

C	C1		E	F	H	Kg
G3/4	G1/4	6355 13 27WP2	10	32	23.5	0.050

6306 Equal and Unequal Tube-to-Tube Connector

Bio-based polymer, EPDM

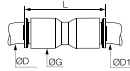

ØD	ØD1		G	L	Kg
4	4	6306 04 00WP2	8.5	26.5	0.002
	6	6306 04 06WP2	10.5	29	0.002
	8	6306 04 08WP2	13.5	37	0.005
6	6	6306 06 00WP2	10.5	30	0.004
	8	6306 06 08WP2	13.5	37	0.005
	10	6306 06 10WP2	16	42	0.007
8	8	6306 08 00WP2	13.5	37	0.004
	10	6306 08 10WP2	16	42	0.007
	12	6306 08 12WP2	19	50	0.012
10	10	6306 10 00WP2	16	42	0.009
	12	6306 10 12WP2	19	50	0.013
12	12	6306 12 00WP2	19	50.5	0.009
16	16	6306 16 00	27	60.5	0.023

6302 Equal and Unequal Union Elbow

Inch

Bio-based polymer, EPDM

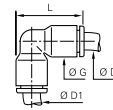

ØD	ØD1		G	L	Kg
5/16	3/8	6302 08 60WP2	16	34	0.009
	1/4	6302 56 00WP2	11	24	0.005
1/4	5/16	6302 56 08WP2	13.5	29.5	0.006
	3/8	6302 56 60WP2	16	34	0.008
3/8	3/8	6302 60 00WP2	16	34	0.006
	1/2	6302 60 62WP2	22	46.5	0.011
1/2	1/2	6302 62 00WP2	22	46.5	0.017

6306 Equal and Unequal Union Connector

Inch

Bio-based polymer, EPDM

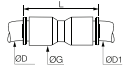

ØD	ØD1		G	L	Kg
5/16	3/8	6306 08 60WP2	16	42	0.008
	1/2	6306 08 62WP2	22	55	0.018
1/4	1/4	6306 56 00WP2	11	30	0.004
	3/8	6306 56 60WP2	16	41	0.007
3/8	3/8	6306 60 00WP2	16	42	0.006
	1/2	6306 60 62WP2	22	56	0.020
1/2	1/2	6306 62 00WP2	22	57	0.016

6304 Union Tee

Bio-based polymer, EPDM

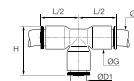

ØD	ØD1		G	H	L/2	Kg
4	4	6304 04 00WP2	8.5	20	15.5	0.004
6	6	6304 06 00WP2	10.5	23	18	0.006
8	8	6304 08 00WP2	13.5	29	22.5	0.006
10	10	6304 10 00WP2	16	34.5	26.5	0.009
12	12	6304 12 00WP2	19	40	31	0.014
16	16	6304 16 00	27	53	39	0.037
	12	6304 16 12	27	53	39	0.063

6302 Equal and Unequal Elbow

Bio-based polymer, EPDM

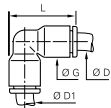

ØD	ØD1		G	L	Kg
4	4	6302 04 00WP2	8.5	19	0.002
	6	6302 04 06WP2	10.5	24	0.004
6	6	6302 06 00WP2	10.5	24	0.004
	8	6302 06 08WP2	13.5	29.5	0.006
8	8	6302 08 00WP2	13.5	29	0.004
	10	6302 08 10WP2	16	34.5	0.008
10	10	6302 10 00WP2	16	34.5	0.005
	12	6302 10 12WP2	19	40.5	0.013
12	12	6302 12 00WP2	19	40.5	0.010
16	16	6302 16 00	27	53	0.024

6304 Equal and Unequal Union Tee

Inch

Bio-based polymer, EPDM

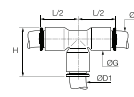

ØD	ØD1		G	H	L/2	Kg
1/4	1/4	6304 56 00WP2	11	24	18	0.002
3/8	3/8	6304 60 00WP2	16	34	26	0.009
	1/4	6304 60 56WP2	16	34	26	0.011
1/2	1/2	6304 62 00WP2	22	47	36	0.027
	3/8	6304 62 60WP2	22	47	36	0.009

5/32" (4mm) and 5/16" (8mm) also available

6340 Equal Single Y Piece

Bio-based polymer, EPDM

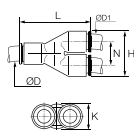

ØD	ØD1		H	K	L	N	Kg
4	4	6340 04 00WP2	17.5	8.5	30	9	0.004
6	6	6340 06 00WP2	21.5	10.5	36.5	11	0.008
8	8	6340 08 00WP2	28	13.5	44.5	14.5	0.007
10	10	6340 10 00WP2	33	16	53	17	0.010
12	12	6340 12 00WP2	39	19	60.5	20	0.025

6340 Equal Single Y Piece

Inch

Bio-based polymer, EPDM

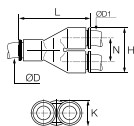

ØD	ØD1		H	K	L	N	Kg
1/4	1/4	6340 56 00WP2	22	11	36	11.5	0.010
3/8	3/8	6340 60 00WP2	33	16	53	17	0.011
1/2	1/2	6340 62 00WP2	45	22	67	23	0.028

5/32" (4 mm) and 5/16" (8 mm) also available.

6307 Equal Cross

Bio-based polymer, EPDM

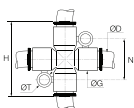

ØD		G	H	N	ØT	Kg
6	6307 06 00WP2	11	36	20	4.2	0.005
8	6307 08 00WP2	13.5	45	22.5	4.2	0.020

6307 Equal Cross

Inch

Bio-based polymer, EPDM

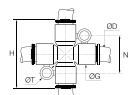

ØD		G	H	L	ØT	Kg
1/4	6307 56 00WP2	11	36	20	4.2	0.010

5/16" (8 mm) also available

6316 Equal Bulkhead Union

Bio-based polymer, EPDM

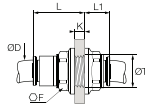

ØD		F	K max	L	L1	ØT min	Kg
4	6316 04 00WP2	13	5.5	15.5	10.5	10.5	0.018
6	6316 06 00WP2	15	8.5	20	10	12.5	0.004
8	6316 08 00WP2	18	14.5	27	10.5	15.5	0.007
10	6316 10 00WP2	22	14.5	30	13	18.5	0.012
12	6316 12 00WP2	26	18.5	35	15.5	22.5	0.020

6316 Bulkhead Union

Inch

Bio-based polymer, EPDM

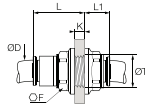

ØD		F	K max	L	L1	ØT min	Kg
1/4	6316 56 00WP2	15	8.5	20	10	12.5	0.004
3/8	6316 60 00WP2	22	14.5	29.5	12.5	18.5	0.012
1/2	6316 62 00WP2	29	20.5	40.5	17	25.5	0.030

5/32" (4mm) and 5/16" (8mm) also available

6976 Bulkhead Union

Stainless steel 316L, EPDM

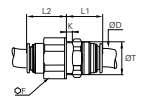

ØD		F	K max	L1	L2	ØT min	Kg
16	6976 16 00	32	10.5	33	30	27.5	0.166

Electrical protection class IP55

Complementary LIQUIfit® Range Products

The other LIQUIfit® range products are presented in the corresponding chapters of this catalogue:

Technical Tubing and Hose

Advanced PE



Function Fittings

Non-Return Valves



Industrial Ball Valves

LIQUIfit® Ball Valves



6382 Equal and Unequal Plug-In Elbow

Bio-based polymer, EPDM

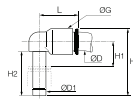

ØD	ØD1		G	H	H1	H2	L	Kg
4	4	6382 04 00WP2	8.5	23	6	15.5	15	0.003
	6	6382 04 06WP2	10.5	26.5	7	17	16.5	0.002
	6	6382 06 00WP2	10.5	26.5	7	17	17	0.003
6	4	6382 06 04WP2	10.5	25	7	15.5	17	0.001
	8	6382 06 08WP2	13.5	33.5	8	21.5	22.5	0.004
8	8	6382 08 00WP2	13.5	33.5	8	21.5	22.5	0.004
	10	6382 08 10WP2	16	39	9.5	24.5	26	0.007
10	10	6382 10 00WP2	16	39	9.5	24.5	26.5	0.004
	12	6382 10 12WP2	19	44.5	10	27	30	0.011
12	12	6382 12 00WP2	19	44.5	10	27	31	0.012

The references in diameter 4mm and 12mm are not grooved in standard version

6383 Plug-In Equal Run Tee

Bio-based polymer, EPDM

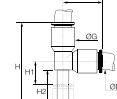

ØD	ØD1		G	H	H1	H2	L	Kg
4	4	6383 04 00WP2	8.5	33	6	15.5	15	0.002
6	6	6383 06 00WP2	10.5	38.5	7	17	18	0.002
8	8	6383 08 00WP2	13.5	49	8	21.5	23	0.005
10	10	6383 10 00WP2	16	57	10.5	25.5	26.5	0.012

6382 Equal and Unequal Plug-In Elbow

Inch

Bio-based polymer, EPDM

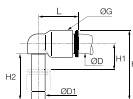

ØD	ØD1		G	H	H1	H2	L	Kg
5/16	3/8	6382 08 60WP2	16	39	10	24.5	26	0.009
1/4	1/4	6382 56 00WP2	11	30.5	11	18	18	0.002
	3/8	6382 56 60WP2	16	39	9	24.5	25.5	0.006
3/8	3/8	6382 60 00WP2	16	39	9	24.5	26.5	0.005
1/2	1/2	6382 62 00WP2	22	49	13	28.5	36	0.004

Equal plug-in elbow: 5/32" (4 mm) and 5/16" (8 mm) also available
The references in diameter 4mm and 12mm are not grooved in standard version

6388 Plug-In Equal Branch Tee

Bio-based polymer, EPDM

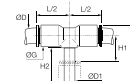

ØD	ØD1		G	H	H1	H2	L/2	Kg
4	4	6388 04 00WP2	8.5	25	6	15.5	15	0.005
6	6	6388 06 00WP2	10.5	28.5	7	17	16	0.006
8	8	6388 08 00WP2	13.5	33.5	8	21.5	23	0.005
10	10	6388 10 00WP2	16	41	9.5	24.5	26.5	0.007

6380 Plug-In 45° Equal Elbow

Bio-based polymer, EPDM

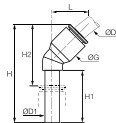

ØD	ØD1		G	H	H1	H2	L	Kg
4	4	6380 04 00WP2	8.5	33.5	19	21	13	0.001
6	6	6380 06 00WP2	11	39	21	25	14.5	0.002
8	8	6380 08 00WP2	13.5	44	21.5	25.5	19.5	0.006
10	10	6380 10 00WP2	16	53	27	32.5	23	0.004
12	12	6380 12 00WP2	19	58	27	34	26	0.012

6388 Plug-In Branch Tee

Inch

Bio-based polymer, EPDM

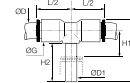

ØD	ØD1		G	H	H1	H2	L/2	Kg
1/4	1/4	6388 56 00WP2	11	30.5	11	20	18	0.002
3/8	3/8	6388 60 00WP2	16	42	12	25	25	0.008

5/32" (4 mm) and 5/16" (8 mm) also available.
For rotary applications, we recommend the use of a special grooved version, available upon request.

6366 Plug-In Reducer

Bio-based polymer, EPDM

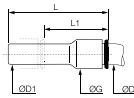

ØD	ØD1		G	L	L1	Kg
4	6	6366 04 06WP2	8.5	38	23.5	0.004
	8	6366 04 08WP2	8.5	38	19	0.004
6	8	6366 06 08WP2	10.5	38	20	0.004
	10	6366 06 10WP2	10.5	39	17.5	0.002
8	10	6366 08 10WP2	13.5	48.5	28.5	0.009
	12	6366 08 12WP2	13.5	48.5	24.5	0.004
10	12	6366 10 12WP2	16	52	33.5	0.005
	14	6366 10 14WP2	16	53	33.5	0.005

6366 Plug-In Reducer

Inch

Bio-based polymer, EPDM

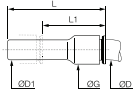

ØD	ØD1		G	L	L1	Kg
1/4	5/16	6366 56 08WP2	11	41	22.5	0.015
	3/8	6366 56 60WP2	11	41	20.5	0.002
5/16	3/8	6366 08 60WP2	13.5	48.5	29	0.003
	1/2	6366 08 62WP2	16	48.5	22	0.007
3/8	1/2	6366 60 62WP2	16	51	30	0.011

6368 Plug-In Increaser

Inch

Bio-based polymer, EPDM

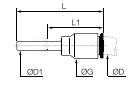

ØD	ØD1		G	L	L1	Kg
3/8	5/16	6368 60 08WP2	16	44	25.5	0.004

6326 Blanking Plug

Bio-based polymer

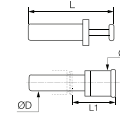

ØD		G	L	L1	Kg
4	6326 04 00WP2	6	30	15.5	0.002
6	6326 06 00WP2	8	33	16.5	0.002
8	6326 08 00WP2	10	35	17.5	0.002
10	6326 10 00WP2	12	42	21	0.003
12	6326 12 00WP2	14	45	22	0.004

6326 Blanking Plug

Inch

Bio-based polymer

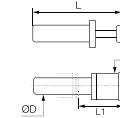

ØD		G	L	L1	Kg
1/4	6326 56 00WP2	8	36.5	22	0.002
3/8	6326 60 00WP2	11.6	42.5	22	0.002
1/2	6326 62 00WP2	14.7	48.5	21.5	0.004

5/32" (4 mm) and 5/16" (8 mm) also available

6322 Plug-In Barb Connector

Bio-based polymer

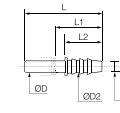

ØD	ØD1	ØD2		L	L1	L2	Kg
6	4	6	6322 06 04WP2	39	25	17	0.004
8	6	8	6322 08 06WP2	43	25	17	0.005
10	7	9	6322 10 07WP2	50	29.5	22	0.006
12	12.5	15.5	6322 12 62WP2	56	32	27.5	0.004

6322 Plug-In Barb Connector

Inch

Bio-based polymer

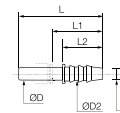

ØD	ØD1	ØD2		L	L1	L2	Kg
1/4	0.28	0.32	6322 56 56WP2	39	24.5	17	0.001
	0.33	0.38	6322 60 08WP2	50	29.5	22	0.002
3/8	0.28	0.32	6322 60 56WP2	45	24.5	17	0.008
	0.40	0.45	6322 60 60WP2	50	29	22	0.002
1/2	0.40	0.45	6322 62 60WP2	58	37.5	30	0.005

6351 End Cap

Bio-based polymer, EPDM



ØD		G	H	Kg
4	6351 04 00WP2	8.5	15	0.001
6	6351 06 00WP2	10.5	17	0.002
8	6351 08 00WP2	13.5	21.5	0.003
10	6351 10 00WP2	16	22	0.003
12	6351 12 00WP2	19	27.5	0.006

6351 End Cap

Inch

Bio-based polymer, EPDM



ØD		G	H	Kg
1/4	6351 56 00WP2	11	16	0.001
3/8	6351 60 00WP2	16	22.5	0.003

5/32" (4 mm) and 5/16" (8 mm) also available

6986 Blanking Plug

Stainless steel 316L

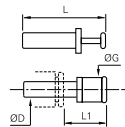

	6986 16 00			
--	-------------------	--	--	--

Up to +150°C

LIQUIfit® Push-in Fittings with Stainless Steel Adaptor



Made of nickel-plated brass or stainless steel, the metal base reinforces the installation of the fitting.

Ø metric:
4 to 16 mm

Technical Characteristics

- **Compatible Fluids:** Water, beverages, industrial fluids: stainless steel threads
Industrial fluids: FDA chemical nickel-plated brass threads
- **Working Pressure:** Vacuum to 16 bar
- **Working Temperature:** -10°C to +130°C (up to 10 bar) for O.D. 4, 6, 8 mm
-10°C to +95°C for all other products

Tightening Torques (BSPP)

Thread	M5 X0.8	G1/8	G1/4	G3/8	G1/2
daN.m	0.16	0.8	1.2	3	3.5

Reliable performance is dependent upon the type of fluid conveyed, component materials and tubing being used.
Use is guaranteed with a vacuum of 755 mm Hg (99% vacuum).

Advantages

- Increased mechanical resistance to tightening
- Compliance with FDA and NSF standards in stainless steel version
- Chemical and mechanical resistance, at high temperature (up to 130°C)
- Bisphenol and phthalate-free

Regulations

- **RoHS**
- **REACH**
- **FDA:** 21 CFR
- **1935/2004**
- **DM 174**
- **ACS**
- **WRAS**
- **KTW** (stainless steel only)
- **W270** (stainless steel only)

Component Materials

Silicone-free

Body:
bio-based polymer

Adaptor:
stainless steel 316L or FDA chemical nickel-plated brass

Grey release button:
technical polymer

Gripping ring:
stainless steel

Seals: EPDM

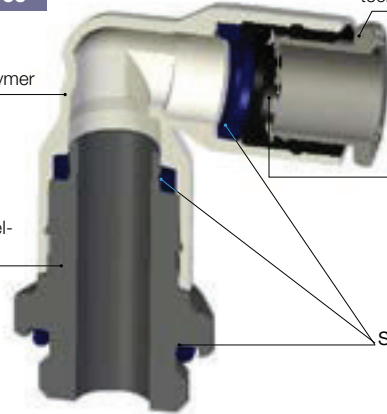

Performance

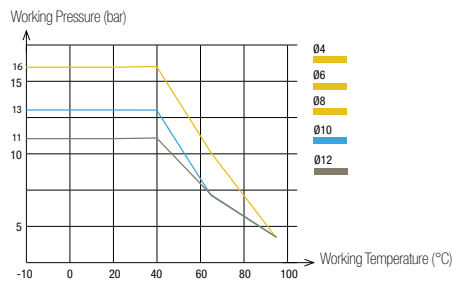

6911 Stud Fitting, Male BSPP and Metric Thread

Stainless steel 316L, EPDM

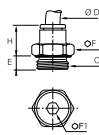

ØD	C	E	F	F1	H	Kg
4	M5x0.8 6911 04 19	3	10	2.5	14	0.006
	G1/8 6911 04 10	4.5	13	3	11.5	0.007
	G1/4 6911 04 13	5.5	16	3	10.5	0.011
6	M5x0.8 6911 06 19	3	11	2.5	16	0.005
	G1/8 6911 06 10	4.5	13	4	13	0.007
	G1/4 6911 06 13	5.5	16	4	12.5	0.011
8	G1/8 6911 08 10	4.5	13	5	20.5	0.011
	G1/4 6911 08 13	5.5	16	6	19.5	0.016
	G3/8 6911 08 17	5.5	21	6	18	0.022
10	G1/4 6911 10 13	5.5	16	7	23	0.018
	G3/8 6911 10 17	5.5	21	8	19.5	0.021
	G1/2 6911 10 21	7	24	8	18	0.033
12	G3/8 6911 12 17	5.5	21	9	27	0.029
	G1/2 6911 12 21	7	24	10	22.5	0.035
	G3/8 6911 16 17	7.5	27	9	32.5	0.060
16	G1/2 6911 16 21	9	27	12	32.5	0.063
	G3/4 6911 16 27	7.5	32	12	32.5	0.096

6975 Stud Fitting, Male BSPT Thread

Stainless steel 316L, EPDM

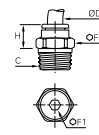

ØD	C	F	F1	H	Kg
4	R1/8 6975 04 10	10	3	9.5	0.005
	R1/4 6975 04 13	14	3	6.5	0.012
6	R1/8 6975 06 10	10	4	11.5	0.005
	R1/4 6975 06 13	14	4	8.5	0.011
8	R1/8 6975 08 10	13	5	20	0.011
	R1/4 6975 08 13	14	6	17	0.014
10	R3/8 6975 08 17	17	6	13	0.021
	R1/4 6975 10 13	16	7	20	0.017
	R3/8 6975 10 17	17	8	16.5	0.019
12	R1/2 6975 10 21	21	8	14	0.037
	R3/8 6975 12 17	19	9	24	0.028
12	R1/2 6975 12 21	21	10	19.5	0.036

6959 Stud Elbow, Male BSPP and Metric Thread

Bio-based polymer, stainless steel 316L, EPDM

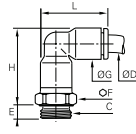

ØD	C		E	F	G	H	L	Kg
4	M5x0.8	6959 04 19	3.5	10	8.5	23	19	0.009
	G1/8	6959 04 10	4.5	13	8.5	22.5	19	0.009
	G1/4	6959 04 13	5.5	16	8.5	22.5	19	0.014
6	M5x0.8	6959 06 19	3.5	10	10.5	26.5	22.5	0.008
	G1/8	6959 06 10	4.5	13	10.5	26.5	22.5	0.011
	G1/4	6959 06 13	5.5	16	10.5	26.5	22.5	0.016
8	G1/8	6959 08 10	4.5	13	13.5	35	29.5	0.018
	G1/4	6959 08 13	5.5	16	13.5	33	29.5	0.020
	G3/8	6959 08 17	5.5	21	13.5	33	29.5	0.028
10	G1/4	6959 10 13	5.5	16	16	40.5	34	0.029
	G3/8	6959 10 17	5.5	21	16	39	34	0.037
	G1/2	6959 10 21	7	24	16	39	34	0.042
12	G1/4	6959 12 13	5.5	19	19	44	40	0.042
	G3/8	6959 12 17	5.5	21	19	42	40	0.040
	G1/2	6959 12 21	7	24	19	42	40	0.049
16	G3/8	6959 16 17	7.5	27	27	54	52	0.088
	G1/2	6959 16 21	9	27	27	55	52	0.084
	G3/4	6959 16 27	10.5	32	27	55	52	0.120

The body swivels for positioning purposes.

6979 Stud Elbow, Male BSPT Thread

Bio-based polymer, stainless steel 316L, EPDM

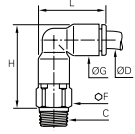

ØD	C		F	G	H	L	Kg
4	R1/8	6979 04 10	10	8.5	23	19	0.008
	R1/4	6979 04 13	14	8.5	23.5	19	0.018
6	R1/8	6979 06 10	10	10.5	27	22.5	0.010
	R1/4	6979 06 13	14	10.5	27.5	22.5	0.020
8	R1/8	6979 08 10	13	13.5	33.5	29.5	0.018
	R1/4	6979 08 13	14	13.5	32.5	29.5	0.022
10	R3/8	6979 08 17	17	13.5	33	29.5	0.032
	R1/4	6979 10 13	15	16	39.5	34	0.031
12	R3/8	6979 10 17	17	16	39.5	34	0.041
	R1/2	6979 10 21	21	16	39.5	34	0.060
12	R3/8	6979 12 17	19	19	45.5	40.5	0.051
	R1/2	6979 12 21	21	19	45.5	40.5	0.065

The body swivels for positioning purposes.

6974 Stud Fitting, Female BSPP Thread

Stainless steel 316L, EPDM

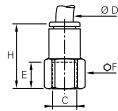

ØD	C		E	F	H	Kg
	G3/8	6974 16 17	17	27	44	0.060
16	G1/2	6974 16 21	21.5	27	17	0.065
	G3/4	6974 16 27	19	32	47	0.097

6958 Stud Branch Tee, Male BSPP and Metric Thread

Bio-based polymer, stainless steel 316L, EPDM

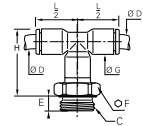

ØD	C		E	F	G	H	L/2	Kg
4	G1/8	6958 04 10	5	13	8.5	22	14	0.009
	G1/4	6958 04 13	5.5	16	8.5	22	14	0.014
6	G1/8	6958 06 10	5	13	10.5	28.5	16	0.011
	G1/4	6958 06 13	5.5	16	10.5	28.5	16	0.016
8	G1/8	6958 08 10	4.5	13	13.5	38	23	0.019
	G3/8	6958 08 17	5.5	21	13.5	36	23	0.030
10	G1/4	6958 10 13	5.5	16	16	43	26.5	0.032
	G3/8	6958 10 17	5.5	21	16	43	26.5	0.055
12	G1/2	6958 10 21	7.5	24	16	43	26.5	0.051
	G3/8	6958 12 17	5.5	21	19	45.5	31	0.042
	G1/2	6958 12 21	7	24	19	45.5	31	0.049

The body swivels for positioning purposes.

6978 Stud Branch Tee, Male BSPT Thread

Bio-based polymer, stainless steel 316L, EPDM

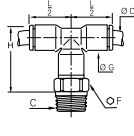

ØD	C		F	G	H	L/2	Kg
4	R1/8	6978 04 10	10	8.5	17	14	0.009
	R1/4	6978 04 13	14	8.5	17	14	0.020
6	R1/8	6978 06 10	10	10.5	23	16	0.011
	R1/4	6978 06 13	14	10.5	23	16	0.011
8	R1/8	6978 08 10	13	13.5	30	23	0.020
	R1/4	6978 08 13	14	13.5	30	23	0.025
8	R3/8	6978 08 17	17	13.5	30	23	0.036
	R1/4	6978 10 13	15	16	34.5	26.5	0.033
10	R3/8	6978 10 17	17	16	34.5	26.5	0.043
	R1/2	6978 10 21	21	16	34.5	26.5	0.065
12	R3/8	6978 12 17	19	19	40.5	31	0.053
	R1/2	6978 12 21	21	19	40.5	31	0.061

6973 Stud Run Tee, Male BSPT Thread

Bio-based polymer, stainless steel 316L, EPDM

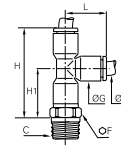

ØD	C		F	G	H	H1	L	Kg
4	R1/8	6973 04 10	10	8.5	31	18	14.5	0.009
	R1/4	6973 04 13	14	8.5	31	19	14.5	0.020
6	R1/8	6973 06 10	10	10.5	38	22	17.5	0.011
	R1/4	6973 06 13	14	10.5	39	23	17.5	0.011
8	R1/8	6973 08 10	13	13.5	53	30	23	0.020
	R1/4	6973 08 13	14	13.5	52	29	23	0.025
8	R3/8	6973 08 17	17	13.5	52	29	23	0.036
	R1/4	6973 10 13	15	16	61	35	26.5	0.033
10	R3/8	6973 10 17	17	16	61	35	26.5	0.043
	R1/2	6973 10 21	21	16	61	35	26.5	0.065
12	R3/8	6973 12 17	19	19	70	39	31	0.053
	R1/2	6973 12 21	21	19	70	39	31	0.061

6953 Stud Run Tee, Male BSPP and Metric Thread

Bio-based polymer, stainless steel 316L, EPDM

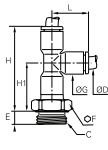

ØD	C		E	F	G	H	H1	L	Kg
4	G1/8	6953 04 10	5	13	8.5	30	18	14.5	0.009
	G1/4	6953 04 13	5.5	16	8.5	30	18	14.5	0.014
6	G1/8	6953 06 10	5	13	10.5	38	22	17.5	0.011
	G1/4	6953 06 13	5.5	16	10.5	38	22	17.5	0.016
8	G1/4	6953 08 13	5.5	16	13.5	52	29	23	0.022
	G3/8	6953 08 17	5.5	21	13.5	52	29	23	0.030
8	G1/4	6953 10 13	5.5	16	16	61	35	26.5	0.032
	G3/8	6953 10 17	5.5	21	16	61	35	26.5	0.055
10	G1/2	6953 10 21	7.5	24	16	61	35	26.5	0.051
	G3/8	6953 12 17	5.5	21	19	67	36	31	0.042
12	G1/2	6953 12 21	7	24	19	67	36	31	0.049

Complementary Products for LIQUIfit® with Stainless Steel Adaptors

Technical Tubing and Hose

Advanced PE

FEP

PFA



6901 Stud Fitting, Male BSPP and Metric Thread

FDA chemical Nickel-plated brass, EPDM

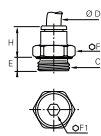

ØD	C		E	F	F1	H	Kg
4	M5x0.8	6901 04 19	3	8	2.5	14	0.003
	G1/8	6901 04 10	5.5	13	3	11.5	0.007
	G1/4	6901 04 13	5.5	16	3	10.5	0.011
6	M5x0.8	6901 06 19	3	11	2.5	16	0.005
	G1/8	6901 06 10	4.5	13	4	13	0.007
	G1/4	6901 06 13	5.5	16	4	12.5	0.011
	G1/8	6901 08 10	4.5	13	5	20.5	0.011
8	G1/4	6901 08 13	5.5	16	6	19.5	0.016
	G3/8	6901 08 17	5.5	20	6	18	0.022
	G1/4	6901 10 13	5.5	16	7	23	0.018
10	G3/8	6901 10 17	5.5	20	8	19.5	0.021
	G1/2	6901 10 21	7	24	8	18	0.033
12	G1/2	6901 12 21	7	24	10	22.5	0.035

6999 Stud Elbow, Male BSPP and Metric Thread

Bio-based polymer, FDA chemical Nickel-plated brass, EPDM

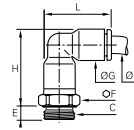

ØD	C		E	F	G	H	L	Kg
4	M5x0.8	6999 04 19	3.5	8	8.5	23	19	0.005
	G1/8	6999 04 10	4.5	13	8.5	22.5	19	0.009
	M5x0.8	6999 06 19	3.5	10	10.5	26.5	22.5	0.008
6	G1/8	6999 06 10	4.5	13	10.5	26.5	22.5	0.011
	G1/4	6999 06 13	5.5	16	10.5	26.5	22.5	0.016
	G1/8	6999 08 10	4.5	13	13.5	35	29.5	0.018
8	G1/4	6999 08 13	5.5	16	13.5	33	29.5	0.020
	G3/8	6999 08 17	5.5	20	13.5	33	29.5	0.028
	G1/4	6999 10 13	5.5	16	16	40.5	34	0.029
10	G3/8	6999 10 17	5.5	20	16	39	34	0.037
	G1/2	6999 10 21	7	24	16	39	34	0.042
12	G3/8	6999 12 17	5.5	20	19	42	40	0.040
	G1/2	6999 12 21	7	24	19	42	40	0.049

The body swivels for positioning purposes.

6905 Stud Fitting, Male BSPT Thread

FDA chemical Nickel-plated brass, EPDM

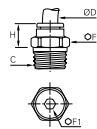

ØD	C		F	F1	H	Kg
4	R1/8	6905 04 10	10	3	9.5	0.005
	R1/4	6905 04 13	14	3	6.5	0.012
6	R1/8	6905 06 10	10	4	11.5	0.005
	R1/4	6905 06 13	14	4	8.5	0.011
	R1/8	6905 08 10	13	5	20	0.011
8	R1/4	6905 08 13	14	6	17	0.014
	R3/8	6905 08 17	17	6	13	0.021
	R1/4	6905 10 13	16	7	20	0.017
10	R3/8	6905 10 17	17	8	16.5	0.019
	R1/2	6905 10 21	21	8	14	0.037
12	R3/8	6905 12 17	19	9	24	0.028
	R1/2	6905 12 21	21	10	19.5	0.036

6909 Stud Elbow, Male BSPT Thread

Bio-based polymer, FDA chemical Nickel-plated brass, EPDM

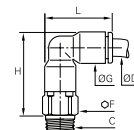

ØD	C		F	G	H	L	Kg
4	R1/8	6909 04 10	10	8.5	23	19	0.008
	R1/4	6909 04 13	14	8.5	23.5	19	0.018
6	R1/8	6909 06 10	10	10.5	27	22.5	0.010
	R1/4	6909 06 13	14	10.5	27.5	22.5	0.020
	R1/8	6909 08 10	13	13.5	33.5	29.5	0.018
8	R1/4	6909 08 13	14	13.5	32.5	29.5	0.022
	R3/8	6909 08 17	17	13.5	33	29.5	0.032
	R1/4	6909 10 13	15	16	39.5	34	0.031
10	R3/8	6909 10 17	17	16	39.5	34	0.041
	R1/2	6909 10 21	21	16	39.5	34	0.060
12	R3/8	6909 12 17	19	19	45.5	40.5	0.051
	R1/2	6909 12 21	21	19	45.5	40.5	0.065

The body swivels for positioning purposes.

6998 Stud Branch Tee, Male BSPP and Metric Thread

Bio-based polymer, FDA chemical Nickel-plated brass, EPDM

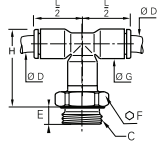

ØD	C		E	F	G	H	L/2	Kg
4	M5x0.8	6998 04 19	3.5	8	8.5	24	14	0.006
	G1/8	6998 04 10	5	13	8.5	22	14	0.009
	G1/4	6998 04 13	5.5	16	8.5	22	14	0.014
6	M5x0.8	6998 06 19	3.5	10	10.5	30	16	0.009
	G1/4	6998 06 13	5.5	16	10.5	29	16	0.016
8	G1/8	6998 08 10	4.5	13	13.5	38	23	0.019
	G1/4	6998 10 13	5.5	16	16	43	26.5	0.032
10	G3/8	6998 10 17	5.5	20	16	43	26.5	0.055
	G1/2	6998 10 21	7.5	24	16	43	26.5	0.051
12	G3/8	6998 12 17	5.5	20	19	45.5	31	0.042
	G1/2	6998 12 21	7	24	19	45.5	31	0.049

The body swivels for positioning purposes.

6993 Stud Run Tee, Male BSPP and Metric Thread

Bio-based polymer, FDA chemical Nickel-plated brass, EPDM

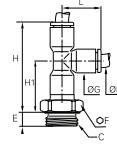

ØD	C		E	F	G	H	H1	L	Kg
4	M5x0.8	6993 04 19	3.5	8	8.5	32	19	14.5	0.006
	G1/8	6993 04 10	5	13	8.5	30	18	14.5	0.009
	G1/4	6993 04 13	5.5	16	8.5	30	18	14.5	0.014
6	M5x0.8	6993 06 19	3.5	10	10.5	39	23	17.5	0.009
	G1/4	6993 06 13	5.5	16	10.5	38	22	17.5	0.016
8	G1/8	6993 08 10	4.5	13	13.5	54	31	23	0.019
	G3/8	6993 08 17	5.5	20	13.5	52	29	23	0.030
10	G3/8	6993 10 17	5.5	20	16	61	35	26.5	0.055
	G1/2	6993 10 21	7.5	24	16	61	35	26.5	0.051
12	G3/8	6993 12 17	5.5	20	19	67	36	31	0.042
	G1/2	6993 12 21	7	24	19	67	36	31	0.049

The body swivels for positioning purposes.

6908 Stud Branch Tee, Male BSPT Thread

Bio-based polymer, FDA chemical Nickel-plated brass, EPDM

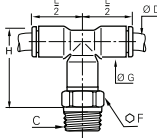

ØD	C		F	G	H	L/2	Kg
4	R1/8	6908 04 10	10	8.5	17	14	0.009
	R1/4	6908 04 13	14	8.5	17	14	0.020
6	R1/4	6908 06 13	14	10.5	23	16	0.011
	R1/8	6908 08 10	13	13.5	30	23	0.020
8	R1/4	6908 08 13	14	13.5	30	23	0.025
	R3/8	6908 08 17	17	13.5	30	23	0.036
	R1/4	6908 10 13	15	16	34.5	26.5	0.033
10	R3/8	6908 10 17	17	16	34.5	26.5	0.043
	R1/2	6908 10 21	21	16	34.5	26.5	0.065
12	R3/8	6908 12 17	19	19	40.5	31	0.053
	R1/2	6908 12 21	21	19	40.5	31	0.061

The body swivels for positioning purposes.

6903 Stud Run Tee, Male BSPT Thread

Bio-based polymer, FDA chemical Nickel-plated brass, EPDM

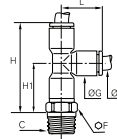

ØD	C		F	G	H	H1	L	Kg
4	R1/8	6903 04 10	10	8.5	31	18	14.5	0.009
	R1/4	6903 04 13	14	8.5	31	19	14.5	0.020
6	R1/4	6903 06 13	14	10.5	39	23	17.5	0.011
	R1/8	6903 08 10	13	13.5	53	30	23	0.020
8	R1/4	6903 08 13	14	13.5	52	29	23	0.025
	R3/8	6903 08 17	17	13.5	52	29	23	0.036
	R1/4	6903 10 13	15	16	61	35	26.5	0.033
10	R3/8	6903 10 17	17	16	61	35	26.5	0.043
	R1/2	6903 10 21	21	16	61	35	26.5	0.065
12	R3/8	6903 12 17	19	19	70	39	31	0.053
	R1/2	6903 12 21	21	19	70	39	31	0.061

The body swivels for positioning purposes.

LF 3600 Push-In Fittings / Stud Fittings



Made of chemical nickel-plated brass, this range of metal fittings is resistant to industrial and food fluids.

Ø metric:
4 to 14 mm

Technical Characteristics

- **Suitable Fluids:** compressed air, grease, lubricant, water...
- **Working Pressure:** vacuum to 30 bar (20 bar: 3699, 3609, 3639)
- **Working Temperature:** -25°C to +150°C

Maximum Tightening Torque (daN.m)	Threads							
	M5 x0.8	M6 x1	M8 x1	M10 x1	G1/8	G1/4	G3/8	G1/2
	0.16	0.18	0.6	0.8	0.8	1.2	3	3.5

Reliable performance is dependent upon the type of fluid conveyed, component materials and tubing being used.

Use is guaranteed with a vacuum of 755 mm Hg (99% vacuum).

Advantages

- Wide range of working temperatures: up to +150°C
- Wide range of working pressures: from vacuum up to 30 bar
- Materials conform to FDA standards
- Extended chemical compatibility

Component Materials

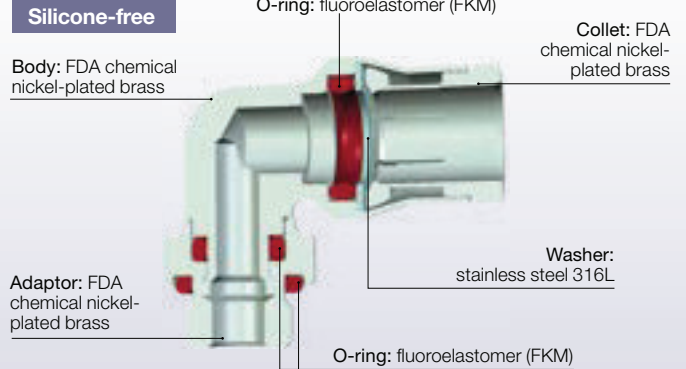

Regulations

- PED
- RoHS
- REACH
- EN 45545-2

3675 Stud Fitting, Male BSPT Thread

FDA chemical Nickel-plated brass, FKM

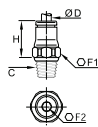

ØD	C		F1	F2	H	Kg
4	R1/8	3675 04 10	10	3	15	0.009
	R1/4	3675 04 13	14	3	15	0.017
6	R1/8	3675 06 10	13	4	17	0.011
	R1/4	3675 06 13	14	4	17	0.018
8	R1/8	3675 08 10	15	5	19	0.015
	R1/4	3675 08 13	16	6	18	0.019
10	R3/8	3675 08 17	17	6	18.5	0.027
	R1/4	3675 10 13	18	7	23	0.026
12	R3/8	3675 10 17	18	8	22.5	0.031
	R1/2	3675 10 21	22	8	22.5	0.056
14	R1/4	3675 12 13	20	7	25.5	0.033
	R3/8	3675 12 17	20	9	24	0.035
14	R1/2	3675 12 21	22	10	23	0.051
	R3/8	3675 14 17	22	9	27	0.042
14	R1/2	3675 14 21	24	11	26	0.057

3601 Stud Fitting, Male BSPP and Metric Thread

FDA chemical Nickel-plated brass, FKM

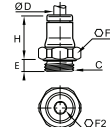

ØD	C		E	F1	F2	H	Kg
4	M5x0.8	3601 04 19	3.5	10	2.5	15.5	0.006
	M6x1	3601 04 52	4.5	10	3	16	0.006
6	M8x1	3601 04 56	5	11	3	14.5	0.007
	G1/8	3601 04 10	5.5	13	3	14.5	0.009
6	G1/4	3601 04 13	6.5	16	3	14.5	0.015
	M5x0.8	3601 06 19	3.5	13	2.5	19	0.010
6	M10x1	3601 06 60	5.5	13	4	17.5	0.011
	G1/8	3601 06 10	5.5	13	4	17.5	0.011
6	G1/4	3601 06 13	6.5	16	4	17	0.015
	G1/8	3601 08 10	5.5	16	5	21	0.014
8	G1/4	3601 08 13	6.5	16	6	18	0.016
	G3/8	3601 08 17	7.5	20	6	19	0.028
8	G1/4	3601 10 13	6.5	18	7	25	0.025
	G3/8	3601 10 17	7.5	20	8	22.5	0.028
10	G1/2	3601 10 21	9	24	8	22.5	0.043
	G1/4	3601 12 13	6.5	20	7	26.5	0.030
12	G3/8	3601 12 17	7.5	20	9	26	0.034
	G1/2	3601 12 21	9	24	10	23.5	0.042
14	G3/8	3601 14 17	7.5	22	9	28	0.038
	G1/2	3601 14 21	9	24	11	26.5	0.045

LF 3600 Push-In Fittings / Stud Fittings

3681 Stud Fitting with Internal Hexagon, Male Metric Thread

FDA chemical Nickel-plated brass, FKM

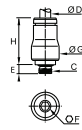

ØD	C		E	F	G	H	Kg
4	M5x0.8	3681 04 19	3.5	2.5	10	16	0.005

3614 Stud Fitting, Female BSPP and Metric Thread

FDA chemical Nickel-plated brass, FKM

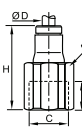

ØD	C		E	F	H	Kg
4	M5x0.8	3614 04 19	5	10	22	0.009
	G1/8	3614 04 10	7.5	14	25	0.016
	G1/4	3614 04 13	11	17	29	0.026
6	G1/8	3614 06 10	7.5	14	27.5	0.019
	G1/4	3614 06 13	11	17	31.5	0.028
8	G1/8	3614 08 10	9.5	15	28.5	0.022
	G1/4	3614 08 13	13.5	17	32.5	0.028
10	G3/8	3614 10 17	14	22	38	0.052
	G3/8	3614 12 17	14	22	39	0.055
12	G1/2	3614 12 21	18.5	24	43.5	0.062

3621 Stud Standpipe, Male BSPT Thread

FDA chemical Nickel-plated brass

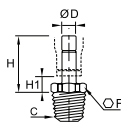

ØD	C		F	H	H1	Kg
4	R1/8	3621 04 10	10	21	7	0.006
6	R1/8	3621 06 10	10	23.5	6.5	0.008
	R1/4	3621 06 13	14	23.5	6.5	0.016
8	R1/8	3621 08 10	10	24	6.5	0.009
	R1/4	3621 08 13	14	24	6.5	0.017
10	R1/4	3621 10 13	14	22	6.5	0.018
	R3/8	3621 10 17	17	30	7.5	0.022
12	R3/8	3621 12 17	17	31	7.5	0.023
	R1/2	3621 12 21	22	31	7.5	0.041
14	R1/2	3621 14 21	22	33	8	0.042

3631 Stud Standpipe, Male BSPP and Metric Thread

FDA chemical Nickel-plated brass, FKM

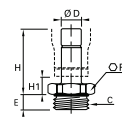

ØD	C		E	F	H	H1	Kg
4	M5x0.8	3631 04 19	3.5	13	21.5	7	0.003
	G1/8	3631 04 10	5.5	13	20	7	0.007
	G1/4	3631 04 13	6.5	8	20	7.5	0.011
6	G1/8	3631 06 10	5.5	13	22.5	6.5	0.009
	G1/4	3631 06 13	6.5	16	22.5	6.5	0.012
8	G1/8	3631 08 10	5.5	13	22.5	6.5	0.010
	G1/4	3631 08 13	6.5	16	23	6.5	0.013
10	G3/8	3631 08 17	7.5	20	23	7.5	0.018
	G1/4	3631 10 13	6.5	16	28	6.5	0.015
10	G3/8	3631 10 17	7.5	20	28	7.5	0.022
	G1/2	3631 10 21	9	24	28	7.5	0.028
12	G3/8	3631 12 17	7.5	20	29	7.5	0.023
	G1/2	3631 12 21	9	24	29	7.5	0.033
14	G1/2	3631 14 21	9	24	31	8	0.033

3600 Cartridge

FDA chemical Nickel-plated brass, FKM

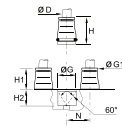

ØD		G	G1	H	H1	H2	N	Kg
4	3600 04 00	9.8	8	17	8.5	8.5	11	0.006
6	3600 06 00	12.1	10	19	10.5	8.5	13.5	0.009
8	3600 08 00	14.8	13	21	12.5	8.5	16	0.012
10	3600 10 00	17.5	15	24.5	14	10.5	20	0.019
12	3600 12 00	20	17	25	14.5	10.5	22.5	0.023
14	3600 14 00	22	20	28.5	16.5	12	25	0.031

Cavity dimension available upon request

3609 Stud Elbow, Male BSPT Thread

FDA chemical Nickel-plated brass, FKM

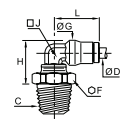

ØD	C		F	G	H	J	L	Kg
4	R1/8	3609 04 10	13	10	15	7	18	0.014
	R1/4	3609 04 13	14	10	17	7	18	0.020
6	R1/8	3609 06 10	13	12	17.5	8	21.5	0.018
	R1/4	3609 06 13	14	12	19	8	21.5	0.025
8	R1/8	3609 08 10	13	15	19.5	10	23.5	0.022
	R1/4	3609 08 13	14	15	21	10	23.5	0.029
10	R3/8	3609 08 17	17	15	21	10	23.5	0.035
	R1/4	3609 10 13	15	17.5	23.5	12	29	0.037
10	R3/8	3609 10 17	17	17.5	25.5	12	29	0.043
	R1/4	3609 12 13	15	19.5	26	15	31	0.049
12	R3/8	3609 12 17	17	19.5	28.5	15	31	0.055
	R1/2	3609 12 21	21	19.5	28.5	15	31	0.072
14	R3/8	3609 14 17	19	21.5	29	16	34	0.063
	R1/2	3609 14 21	22	21.5	30	16	34	0.072

The body swivels for positioning purposes. Maxi pressure = 20 bar

LF 3600 Push-In Fittings / Stud Fittings

3629 Extended Stud Elbow, Male BSPT Thread

FDA chemical Nickel-plated brass, FKM

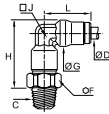

ØD	C		F	G	H	J	L	Kg
4	R1/8	3629 04 10	10	10	24.5	7	18	0.025
	R1/8	3629 06 10	13	12	29.5	8	21.5	0.024
6	R1/4	3629 06 13	14	12	30.5	8	21.5	0.031
	R1/8	3629 08 10	14	15	32.5	10	23.5	0.031
8	R1/4	3629 08 13	14	15	34	10	23.5	0.037
	R1/4	3629 10 13	18	17.5	39	12	29	0.054

The body swivels for positioning purposes.

3669 Extended Stud Elbow, Male BSPP and Metric Thread

FDA chemical Nickel-plated brass, FKM

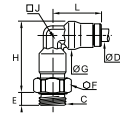

ØD	C		E	F	G	H	J	L	Kg
4	M5x0.8	3669 04 19	3.5	10	10	27.5	7	18	0.014
	G1/8	3669 04 10	5.5	13	10	25.5	7	18	0.017
6	G1/8	3669 06 10	5.5	13	12	31	8	21.5	0.024
	G1/4	3669 06 13	6.5	16	12	30.5	8	21.5	0.028
8	G1/8	3669 08 10	5.5	14	15	33.5	10	23.5	0.031
	G1/4	3669 08 13	5.5	16	15	34	10	23.5	0.035
10	G1/4	3669 10 13	6.5	18	17.5	42	12	29	0.052
	G3/8	3669 10 17	7.5	20	17.5	41	12	29	0.056
12	G1/4	3669 12 13	6.5	20	19.5	47	15	31	0.070
	G3/8	3669 12 17	7.5	20	19.5	46	15	31	0.341
14	G1/2	3669 14 21	9	24	21.5	49	16	34	0.094

The body swivels for positioning purposes.

3699 Compact Elbow, Male BSPP and Metric Thread

FDA chemical Nickel-plated brass, FKM

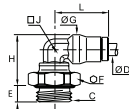

ØD	C		E	F	G	H	J	L	Kg
4	M5x0.8	3699 04 19	3.5	10	10	18	7	18	0.011
	M6x1	3699 04 52	4.5	10	10	18	7	18	0.011
	M8x1	3699 04 56	5	11	10	18	7	18	0.013
	G1/8	3699 04 10	5.5	13	10	17	7	18	0.014
	G1/4	3699 04 13	6.5	16	10	17.5	7	18	0.019
6	M10x1	3699 06 60	5.5	13	12	19	8	21.5	0.017
	G1/8	3699 06 10	5.5	13	12	19	8	21.5	0.018
	G1/4	3699 06 13	6.5	16	12	19.5	8	21.5	0.022
8	G1/8	3699 08 10	5.5	13	15	20.5	10	23.5	0.021
	G1/4	3699 08 13	6.5	16	15	21.5	10	23.5	0.027
	G3/8	3699 08 17	7.5	20	15	21.5	10	23.5	0.033
10	G1/4	3699 10 13	6.5	16	17.5	27	12	29	0.037
	G3/8	3699 10 17	7.5	20	17.5	25.5	12	29	0.043
	G1/4	3699 12 13	6.5	16	19.5	29.5	15	31	0.050
12	G3/8	3699 12 17	7.5	20	19.5	28.5	15	31	0.057
	G1/2	3699 12 21	9	24	19.5	28.5	15	31	0.065
14	G3/8	3699 14 17	7.5	20	21.5	29	16	34	0.059
	G1/2	3699 14 21	9	24	21.5	29.5	16	34	0.062

The body swivels for positioning purposes. Maxi pressure = 20 bar

3608 Stud Branch Tee, Male BSPT Thread

FDA chemical Nickel-plated brass, FKM

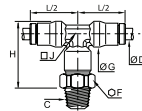

ØD	C		F	G	H	J	L/2	Kg
4	R1/8	3608 04 10	10	10	24.5	7	18	0.020
	R1/8	3608 06 10	13	12	29.5	8	21.5	0.031
6	R1/4	3608 06 13	14	12	30.5	8	21.5	0.038
	R1/8	3608 08 10	14	15	32.5	10	23.5	0.040
8	R1/4	3608 08 13	14	15	34	10	23.5	0.047
	R1/4	3608 10 13	18	17.5	39	12	29	0.067
10	R3/8	3608 10 17	18	17.5	41	12	29	0.070
	R3/8	3608 12 17	20	19.5	46.5	15	31	0.094
14	R1/2	3608 14 21	22	21.5	50.5	16	34	0.125

The body swivels for positioning purposes.

3603 Stud Run Tee, Male BSPT Thread

FDA chemical Nickel-plated brass, FKM

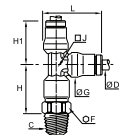

ØD	C		F	G	H	H1	J	L	Kg
4	R1/8	3603 04 10	10	10	19.5	18	7	23	0.018
	R1/8	3603 06 10	13	12	23.5	21.5	8	28	0.031
6	R1/4	3603 06 13	14	12	24.5	21.5	8	28	0.037
	R1/8	3603 08 10	14	15	25	23.5	10	31	0.041
8	R1/4	3603 08 13	14	15	26.5	23.5	10	31	0.044
	R1/4	3603 10 13	18	17.5	30.5	29	12	37.5	0.067
10	R3/8	3603 10 17	18	17.5	32.5	29	12	37.5	0.069
	R3/8	3603 12 17	20	19.5	36.5	31	15	40.5	0.103
14	R1/2	3603 14 21	22	21.5	40	34	16	45	0.147

The body swivels for positioning purposes.

3698 Stud Branch Tee, Male BSPP and Metric Thread

FDA chemical Nickel-plated brass, FKM

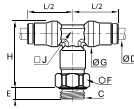

ØD	C		E	F	G	H	J	L/2	Kg
4	M5x0.8	3698 04 19	3.5	10	10	27.5	7	18	0.018
	G1/8	3698 04 10	5.5	13	10	25.5	7	18	0.021
6	G1/8	3698 06 10	5.5	13	12	31	8	21.5	0.031
	G1/4	3698 06 13	6.5	16	12	30.5	8	21.5	0.035
8	G1/8	3698 08 10	5.5	14	15	33.5	10	23.5	0.041
	G1/4	3698 08 13	6.5	16	15	34	10	23.5	0.045
10	G1/4	3698 10 13	6.5	18	17.5	42	12	29	0.066
12	G3/8	3698 12 17	7.5	20	19.5	46	15	31	0.088
14	G1/2	3698 14 21	9	24	21.5	49	16	34	0.119

The body swivels for positioning purposes.

3693 Stud Run Tee, Male BSPP and Metric Thread

FDA chemical Nickel-plated brass, FKM

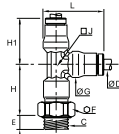

ØD	C		E	F	G	H	H1	J	L	Kg
4	M5x0.8	3693 04 19	3.5	10	10	22.5	18	7	23	0.019
	G1/8	3693 04 10	5.5	13	10	20.5	18	7	23	0.021
6	G1/8	3693 06 10	5.5	13	12	25	21.5	8	28	0.031
	G1/4	3693 06 13	6.5	16	12	24.5	21.5	8	28	0.035
8	G1/8	3693 08 10	5.5	14	15	26.5	23.5	10	31	0.041
	G1/4	3693 08 13	6.5	16	15	26.5	23.5	10	31	0.044
10	G1/4	3693 10 13	6.5	18	17.5	33	29	12	37.5	0.066
12	G3/8	3693 12 17	7.5	20	19.5	36.5	31	15	40.5	0.090
14	G1/2	3693 14 21	9	24	21.5	38.5	34	16	45	0.112

The body swivels for positioning purposes.

3618 Single Banjo, Male BSPP and Metric Thread

FDA chemical Nickel-plated brass, FKM

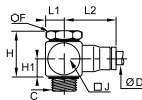

ØD	C		F	H	H1	J	L1	L2	Kg
4	M5x0.8	3618 04 19	8	13	6	10	6	18.5	0.011
	G1/8	3618 04 10	13	16.5	7	15	7.5	22	0.029
6	M5x0.8	3618 06 19	8	13	6	10	5	22.5	0.015
	G1/8	3618 06 10	13	16.5	7	15	7.5	24	0.031
8	G1/4	3618 06 13	17	21	9	18	9	24	0.049
	G1/8	3618 08 10	13	16.5	7	15	7.5	25.5	0.033
10	G1/4	3618 08 13	17	21	9	18	9	26.5	0.051
	G3/8	3618 10 17	20	24.5	11	21.5	11	33	0.105

Maximum temperature: +80°C

3606 Equal Tube-to-Tube Connector

FDA chemical Nickel-plated brass, FKM

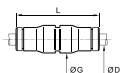

ØD		G	L	Kg
4	3606 04 00	10	30.5	0.010
6	3606 06 00	12	36.5	0.016
8	3606 08 00	15	37.5	0.021
10	3606 10 00	17.5	47.5	0.034
12	3606 12 00	19.5	50	0.042
14	3606 14 00	21.5	52.5	0.050

3602 Equal Elbow

FDA chemical Nickel-plated brass, FKM

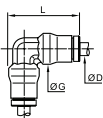

ØD		G	L	Kg
4	3602 04 00	10	23	0.010
6	3602 06 00	12	28	0.016
8	3602 08 00	15	31	0.022
10	3602 10 00	17.5	37.5	0.033
12	3602 12 00	19.5	40.5	0.045
14	3602 14 00	21.5	45	0.056

3604 Equal Tee

FDA chemical Nickel-plated brass, FKM

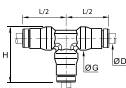

ØD		G	H	L/2	Kg
4	3604 04 00	10	23	18	0.014
6	3604 06 00	12	28	21.5	0.023
8	3604 08 00	15	31	23.5	0.032
10	3604 10 00	17.5	37.5	29	0.048
12	3604 12 00	19.5	40.5	31	0.063
14	3604 14 00	21.5	45	34	0.078

3616 Equal Bulkhead Connector

FDA chemical Nickel-plated brass, FKM

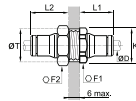

ØD		F1	F2	K	L1	L2	ØT min	Kg
4	3616 04 00	13	14	14	14	20	12.5	0.018
6	3616 06 00	16	17	17.5	17	22	15	0.028
8	3616 08 00	18	19	19.5	18.5	23.5	17	0.036
10	3616 10 00	22	27	24	21.5	26.5	21	0.063
12	3616 12 00	24	24	26	23	27	23	0.062
14	3616 14 00	27	27	29.5	25.5	29.5	25	0.079

3636 Bulkhead Connector, Female BSPP Thread

FDA chemical Nickel-plated brass, FKM

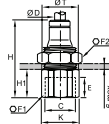

ØD	C	E	F1	F2	H	H1	K	ØT min	Kg
4	G1/8	3636 04 10	8.5	14	14	30.5	11	15	0.020
6	G1/8	3636 06 10	8.5	17	17	33	11	18.5	0.033
	G1/4	3636 06 13	11.5	17	17	37	15	18.5	0.033
8	G1/8	3636 08 10	8.5	19	19	34	10.5	21	0.044
	G1/4	3636 08 13	11.5	19	19	38	14.5	21	0.044
10	G3/8	3636 10 17	12	22	27	42.5	16	24	0.073
12	G3/8	3636 12 17	12	24	24	43	16	26	0.077
	G1/2	3636 12 21	16	27	24	48.5	21.5	29.5	0.133

3639 Equal Bulkhead Elbow

FDA chemical Nickel-plated brass, FKM

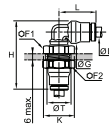

ØD		F1	F2	G	H	K	L	ØT min	Kg
4	3639 04 00	13	14	10	35	14	18	12.5	0.023
6	3639 06 00	16	17	12	40.5	17.5	21.5	15	0.035
8	3639 08 00	18	19	15	44	19.5	23.5	17	0.046
10	3639 10 00	22	27	17.5	51	24	29	21	0.080
12	3639 12 00	24	24	19.5	55	26	31	23	0.086
14	3639 14 00	27	27	21.5	59	29.5	34	25	0.144

The body swivels for positioning purposes.
Maxi pressure = 20 bar

LF 3600 Push-In Fittings / Plug-In Accessories

3666 Plug-In Reducer

FDA chemical Nickel-plated brass, FKM

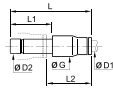

ØD1	ØD2		G	L	L1	L2	Kg
4	6	3666 04 06	10	35	19.5	18	0.008
	8	3666 04 08	10	35.5	20	18	0.009
6	8	3666 06 08	12	38	20	20.5	0.012
	10	3666 06 10	12	43.5	25	21	0.015
8	10	3666 08 10	15	44	25	21.5	0.016
	12	3666 08 12	15	44	26	20.5	0.018
10	12	3666 10 12	17.5	50	26	27	0.026
12	14	3666 12 14	19.5	53	28	28.5	0.032

3667 Plug-In Metric/Inch Adaptor

FDA chemical Nickel-plated brass, FKM

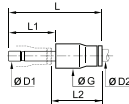

ØD1	ØD2		G	L	L1	L2	Kg
6	1/4	3667 06 56	12.5	38.5	19.5	21	0.012
10	3/8	3667 10 60	17	49.5	25	27	0.026
12	1/2	3667 12 62	20	51	26	27.5	0.030

3668 Plug-In Increaser

FDA chemical Nickel-plated brass, FKM

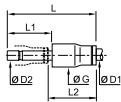

ØD1	ØD2		G	L	L1	L2	Kg
6	4	3668 06 04	12	36	17	21.5	0.010

3622 Plug-In Barb Connector

FDA chemical Nickel-plated brass

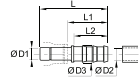

ØD1	ØD2	ØD3		L	L1	L2	Kg
4	3.2	5	3622 04 53	40.5	27	22.5	0.003
	5	7	3622 04 05	40.5	27	22.5	0.005
6	5	7	3622 06 05	43	27	22.5	0.006
	6.3	8.3	3622 08 56	42	25	22.5	0.008
8	8	10	3622 08 08	44	27	22.5	0.010
	6.3	8.3	3622 10 56	47.5	25.5	22.5	0.011
10	8	10	3622 10 08	47.5	25.5	22.5	0.011
	8	10	3622 12 08	48.5	25.5	22.5	0.015
12	10	12	3622 12 10	48.5	25.5	22.5	0.014
	12.5	14.5	3622 12 62	57	34	29.5	0.019
14	12.5	14.5	3622 14 62	57.5	33	29.5	0.022
	14	16	3622 14 14	59.5	35	29.5	0.023

3620 Male Stem Connector

FDA chemical Nickel-plated brass

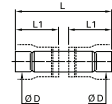

ØD		L	L1	Kg
4	3620 04 00	31	14	0.002
6	3620 06 00	36.5	17	0.005
8	3620 08 00	37.5	17.5	0.007
10	3620 10 00	47.5	22.5	0.011
12	3620 12 00	49.5	23.5	0.015
14	3620 14 00	53	25	0.016

3626 Blanking Plug

FDA chemical Nickel-plated brass

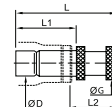

ØD		G	L	L1	L2	Kg
4	3626 04 00	6	25.5	17.5	11.5	0.004
6	3626 06 00	8	30.5	19.5	13.5	0.009
8	3626 08 00	10	33	20	16	0.009
10	3626 10 00	12	40	25	18	0.015
12	3626 12 00	14	43	26	20	0.021
14	3626 14 00	16	47	28	22.5	0.029

LF 3600 Push-In Fittings / Maintenance Kit



.....
The essential tool to rapidly carry out the main maintenance operations and reduce production interruptions.
.....

Advantages

- A selection of 24 references covering the most-used products
- Products available in the most common diameters: 4 mm, 6 mm and 8 mm
- A kit contains more than 232 products and can be easily completed with our standard products

3650..33 Maintenance Kit



3650 00 00 33

H L L1 Kg

81 413 330 2.900

Low Lead Brass LF 3600 Push-In Fittings



This range is designed for applications that require low lead content within the circuit components. These products are made to order, according to your needs and specifications. Please contact us for any project.

Ø metric:
4 to 8 mm

Technical Characteristics

- **Compatible Fluids:** drinking water and vapour
Other fluids: please consult us
- **Working Pressure:** Vacuum to 30 bar. Models 3609, 3699 and 3639 are limited to 20 bar
- **Working Temperature:** -25°C to +150°C

Maximum Tightening Torque (daN.m)	Threads		
	M5x0.8	G1/8	G1/4
	0.06	0.8	1.2

Les performances dépendent des fluides, du diamètre et de la nature du tube utilisé. L'utilisation est garantie pour un vide de 755 mm HG (99% de vide).

Advantages

- Dedicated to coffee machines and beverage vending machines

Component Materials

Silicone-free

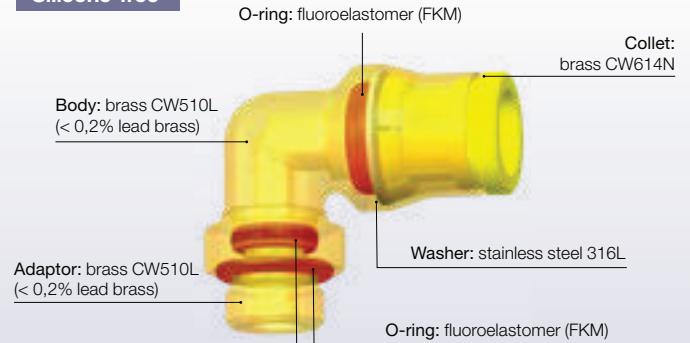

Regulations

- 1935/2004
- NSF/ANSI 169
- DM 174
- FDA : 21 CFR
- RoHS
- REACH
- EN 16889
- LFGB

3601 Stud Fitting, Male BSPP and Metric Thread

Low lead brass, FKM

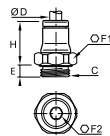

ØD	C		E	F1	F2	H	Kg
4	G1/8	3601 04 10 84	5.5	13	3	14.5	0.009
	G1/4	3601 04 13 84	6.5	16	3	14.5	0.015
	M5x0.8	3601 04 19 84	3.5	10	2.5	15.5	0.006
6	G1/8	3601 06 10 84	5.5	13	4	17.5	0.011
	G1/4	3601 06 13 84	6.5	16	4	17	0.015
8	G1/8	3601 08 10 84	5.5	16	5	21	0.014

3609 Stud Elbow, Male BSPT Thread

Low lead brass, FKM

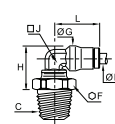

ØD	C		F	G	H	J	L	Kg
4	R1/8	3609 04 10 84	13	10	15	7	18	0.014
	R1/4	3609 04 13 84	14	10	17	7	18	0.020
6	R1/8	3609 06 10 84	13	12	17.5	8	21.5	0.018
	R1/4	3609 06 13 84	14	12	19	8	21.5	0.025

The body swivels for positioning purposes.

3608 Stud Branch Tee, Male BSPT Thread

Low lead brass, FKM

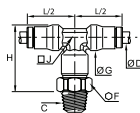

ØD	C		F	G	H	J	L/2	Kg
4	R1/8	3608 04 10 84	10	10	24.5	7	18	0.020

The body swivels for positioning purposes.

3614 Stud Fitting, Female BSPP Thread

Low lead brass, FKM

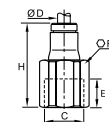

ØD	C		E	F	H	Kg
4	G1/8	3614 04 10 84	7.5	14	25	0.016
	G1/4	3614 04 13 84	11	17	29	0.026
6	G1/8	3614 06 10 84	7.5	14	27.5	0.019
	G1/4	3614 06 13 84	11	17	31.5	0.028

Low Lead Brass LF 3600 Push-In Fittings

3621 Stud Standpipe, Male BSPT Thread

Low lead brass

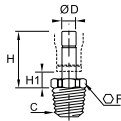

ØD	C		F	H	H1	Kg
6	R1/8	3621 06 10 84	10	23.5	6.5	0.008

3631 Stud Standpipe, Male BSPP Thread

Low lead brass, FKM

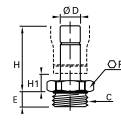

ØD	C		E	F	H	H1	Kg
8	G1/8	3631 08 10 84	5.5	13	22.5	6.5	0.010

3675 Stud Fitting, Male BSPT Thread

Low lead brass, FKM

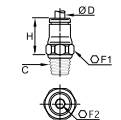

ØD	C		F1	F2	H	Kg
4	R1/8	3675 04 10 84	10	3	15	0.009
	R1/4	3675 04 13 84	14	3	15	0.017
6	R1/8	3675 06 10 84	13	4	17	0.011

3693 Stud Run Tee, Male BSPP and Metric Thread

Low lead brass, FKM

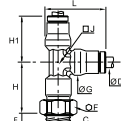

ØD	C		E	F	G	H	H1	J	L	Kg
4	G1/8	3693 04 10 84	5.5	13	10	20.5	18	7	23	0.021
6	G1/8	3693 06 10 84	5.5	13	12	25	21.5	8	28	0.031

The body swivels for positioning purposes.

3698 Stud Branch Tee, Male BSPP and Metric Thread

Low lead brass, FKM

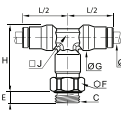

ØD	C		E	F	G	H	J	L/2	Kg
6	G1/8	3698 06 10 84	5.5	13	12	31	8	21.5	0.031

The body swivels for positioning purposes.

3699 Compact Elbow, Male BSPP and Metric Thread

Low lead brass, FKM

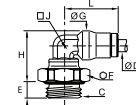

ØD	C		E	F	G	H	J	L	Kg
4	M5x0.8	3699 04 19 84	3.5	10	10	18	7	18	0.011
	G1/8	3699 04 10 84	5.5	13	10	17	7	18	0.014
	G1/4	3699 04 13 84	6.5	16	10	17.5	7	18	0.019
6	G1/8	3699 06 10 84	5.5	13	12	19	8	21.5	0.018
	G1/4	3699 06 13 84	6.5	16	12	19.5	8	21.5	0.022
8	G1/8	3699 08 10 84	5.5	13	15	20.5	10	23.5	0.021

The body swivels for positioning purposes.

3602 Equal Elbow

Low lead brass, FKM

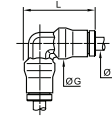

ØD			G	L	Kg
4	3602 04 00 84		10	23	0.010

3603 Stud Run Tee, Male BSPT Thread

Low lead brass, FKM

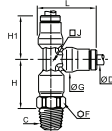

ØD	C		F	G	H	H1	J	L	Kg
4	R1/8	3603 04 10 84	10	10	19.5	18	7	23	0.018

The body swivels for positioning purposes.

3604 Equal Tee

Low lead brass, FKM

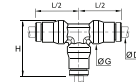

ØD			G	H	L/2	Kg
4	3604 04 00 84		10	23	18	0.014
6	3604 06 00 84		12	28	21.5	0.023

3639 Equal Bulkhead Elbow

Low lead brass, FKM

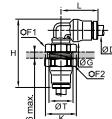

ØD			F1	F2	G	H	K	L	ØT min	Kg
4	3639 04 00 84		13	14	10	35	14	18	12.5	0.023

The body swivels for positioning purposes.

Low Lead Brass LF 3600 Push-In Fittings

3620 Male Stem Connector

Low lead brass

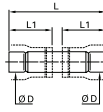

ØD		L	L1	Kg
4	3620 04 00 84	31	14	0.002
6	3620 06 00 84	36.5	17	0.005

3622 Plug-In Barb Connector

Low lead brass

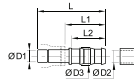

ØD1	ØD2	ØD3		L	L1	L2	Kg
4	3.2	5	3622 04 53 84	40.5	27	22.5	0.003

3626 Blanking Plug

Low lead brass

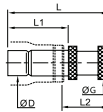

ØD		G	L	L1	L2	Kg
4	3626 04 00 84	6	25.5	17.5	11.5	0.004

Related Products

- Polyurethane Tubing
- Polyamide Tubing
- Polyethylene Tubing
- Fluoropolymer Tubing
- Anti-Spark Tubing
- Fireproof PA Tubing
- Brass Flow Control Regulators

LF 3800 Push-In Fittings / Stud Fittings



Made of 316L stainless steel, this range is suitable for conveying corrosive or food fluids, in aggressive environments or for high hygiene requirements.

Ø metric: 4 to 12 mm
Ø inch: 3/16" to 1/2"

Technical Characteristics

- **Compatible Fluids:** All fluids compatible with the fitting component materials
- **Working Pressure:** Vacuum to 30 bar (20 bar: 3879 and 3889)
- **Working Temperature:** -25°C to +150°C

Adaptor Tightening Torque	Threads	M5 x0.8	G1/8	G1/4	G3/8	G1/2
	daN.m	0.16	0.8	1.2	3	3.5

Bulkhead Tightening Torque	Ø (mm)	4	6	8	10	12
	daN.m min. max.		0.5 0.9	0.5 0.9	0.6 1	0.6 1

Reliable performance is dependent upon the type of fluid conveyed, component materials and tubing being used.

Use is guaranteed with a vacuum of 755 mm Hg (99% vacuum).

Technical performance tested at -25°C according to the ISO 14743 standard.

Regulations

- ISO 14743
- RoHS
- REACH
- FDA : 21 CFR
- PED

Component Materials

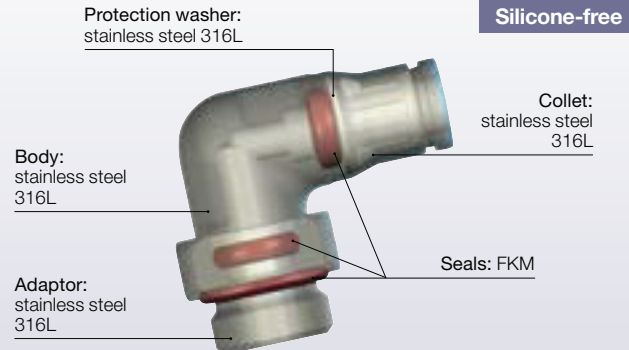

Advantages

- Resistance to corrosion thanks to the component material
- Suitable for permanent food contact
- Suitable for industrial cleaning agents and detergents
- Hygienic external design, for reducing retention zones

3805 Stud Fitting, Male BSPT Thread

Stainless steel 316L, FKM

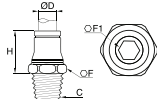

ØD	C		F	F1	H	Kg
4	R1/8	3805 04 10	10	3	14.5	0.008
	R1/4	3805 04 13	14	3	14.5	0.015
6	R1/8	3805 06 10	13	4	18	0.012
	R1/4	3805 06 13	14	4	16.5	0.018
8	R1/8	3805 08 10	15	5	19	0.014
	R1/4	3805 08 13	15	6	18	0.018
	R3/8	3805 08 17	17	6	18.5	0.025
10	R1/4	3805 10 13	19	6	24	0.029
	R3/8	3805 10 17	19	6	22.5	0.030
12	R1/4	3805 12 13	22	7	25	0.034
	R3/8	3805 12 17	22	8	24	0.040
	R1/2	3805 12 21	22	10	23	0.046

3805 Stud Fitting, Male NPT Thread

Stainless steel 316L, FKM

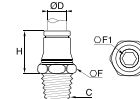

ØD	C		F	F1	H	Kg
4	NPT1/8	3805 04 11	11	3	14.5	0.009
	NPT1/8	3805 06 11	13	4	18	0.012
6	NPT1/4	3805 06 14	14	4	16.5	0.017
	NPT1/8	3805 08 11	15	5	19	0.015
8	NPT1/4	3805 08 14	15	6	18	0.018
	NPT1/8	3805 10 14	19	6	24	0.028
10	NPT3/8	3805 10 18	19	7	22.5	0.031
	NPT1/4	3805 12 14	22	7	25	0.034
12	NPT3/8	3805 12 18	22	8	24	0.039
	NPT1/2	3805 12 22	22	10	23	0.045

LF 3800 Push-In Fittings / Stud Fittings

3805 Stud Fitting, Male NPT Thread

Inch

Stainless steel 316L, FKM

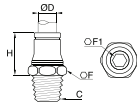

ØD	C		F	F1	H	Kg
3/16	NPT1/8	3805 55 11	10	3	15.5	0.010
	NPT1/8	3805 56 11	13	4	19	0.012
1/4	NPT1/4	3805 56 14	14	4	17.5	0.017
	NPT1/4	3805 60 14	19	6	25	0.029
3/8	NPT3/8	3805 60 18	19	7	24	0.031
	NPT1/4	3805 62 14	22	7	26	0.036
1/2	NPT3/8	3805 62 18	22	8	25	0.041
	NPT1/2	3805 62 22	22	10	25	0.049

5/32" (4 mm) and 5/16" (8 mm) also available

3801 Stud Fitting, Male BSPP and Metric Thread

Stainless steel 316L, FKM

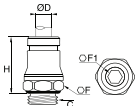

ØD	C		F	F1	H	Kg
4	M5x0.8	3801 04 19	10	2.5	17	0.005
	G1/8	3801 04 10	13	3	16.5	0.009
6	M5x0.8	3801 06 19	13	2.5	20.5	0.010
	G1/8	3801 06 10	13	4	18	0.010
8	G1/4	3801 06 13	17	4	18	0.015
	G1/8	3801 08 10	15	5	19	0.013
10	G1/4	3801 08 13	17	5	20.5	0.017
	G3/8	3801 08 17	21	6	20	0.027
12	G1/4	3801 10 13	19	7	25	0.025
	G3/8	3801 10 17	21	7	25	0.034
12	G1/4	3801 12 13	21	7	27	0.030
	G3/8	3801 12 17	21	9	26.5	0.034

3821 Stud Standpipe, Male BSPT Thread

Stainless steel 316L

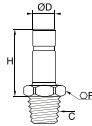

ØD	C		F	H	Kg
4	R1/8	3821 04 10	10	21	0.006
	R1/8	3821 06 10	10	23	0.007
6	R1/4	3821 06 13	14	24	0.015
	R1/8	3821 08 10	11	24	0.008
8	R1/4	3821 08 13	14	25	0.016
	R1/4	3821 10 13	19	30	0.017
10	R3/8	3821 10 17	19	30	0.022
	R1/4	3821 12 13	19	31	0.017
12	R3/8	3821 12 17	19	31	0.022
	R1/2	3821 12 21	22	32	0.037

3821 Stud Standpipe, Male NPT Thread

Stainless steel 316L

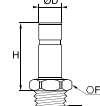

ØD	C		F	H	Kg
4	NPT1/8	3821 04 11	10	21	0.006
	NPT1/8	3821 06 11	10	23	0.007
6	NPT1/4	3821 06 14	14	24	0.016
	NPT1/8	3821 08 11	14	24	0.008
8	NPT1/4	3821 08 14	14	25	0.016
	NPT1/4	3821 10 14	14	30	0.018
10	NPT3/8	3821 10 18	17	30	0.010
	NPT1/4	3821 12 14	14	31	0.018

3821 Stud Standpipe, Male NPT Thread

Inch

Stainless steel 316L

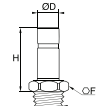

ØD	C		F	H	Kg
1/4	NPT1/8	3821 56 11	10	26	0.009
	NPT1/4	3821 56 14	14	27	0.016
3/8	NPT1/4	3821 60 14	19	32	0.018
	NPT3/8	3821 60 18	19	32	0.028
1/2	NPT1/4	3821 62 14	19	36	0.020
	NPT3/8	3821 62 18	19	37	0.025
1/2	NPT1/2	3821 62 22	22	37	0.042

5/32"(4 mm) and 5/16"(8 mm) also available

3831 Stud Standpipe, Male BSPP and Metric Thread

Stainless steel 316L, FKM

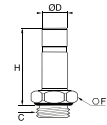

ØD	C		F	H	Kg
4	M5x0.8	3831 04 19	10	23.5	0.004
	G1/8	3831 04 10	13	22	0.008
6	G1/8	3831 06 10	13	24	0.009
	G1/4	3831 06 13	17	24	0.015
8	G1/8	3831 08 10	13	25	0.010
	G1/4	3831 08 13	17	27	0.019
10	G3/8	3831 08 17	21	27	0.024
	G1/4	3831 10 13	17	32	0.021
12	G3/8	3831 10 17	21	32	0.025
	G1/4	3831 12 13	17	33	0.021
12	G3/8	3831 12 17	21	33	0.028
	G1/2	3831 12 21	24	36	0.043

Stud standpipe 3821 and 3831 can be used as illustrated, allowing:

- stock optimisation
- installation of tees and elbows where required

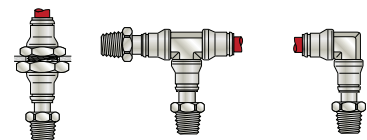

LF 3800 Push-In Fittings / Stud Fittings

3800 Cartridge

Stainless steel 316L, FKM

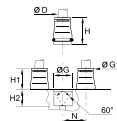

ØD		G	G1	H	H1	H2	N	Kg
4	3800 04 00	9.8	8	17	8.5	8.5	11	0.006
6	3800 06 00	12.1	10	19	10.5	8.5	13.5	0.008
8	3800 08 00	14.8	13	21	12.5	8.5	16	0.012
10	3800 10 00	17.5	15	24.5	14	10.5	20	0.019

Cavity dimensions available on request

3809 Stud Elbow, Male BSPT Thread

Stainless steel 316L, FKM

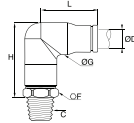

ØD	C	F	G	H	L	Kg
4	R1/8 3809 04 10	10	10	23.5	16.5	0.020
	R1/8 3809 06 10	13	12	27.5	20	0.030
6	R1/4 3809 06 13	14	12	27.5	25	0.036
	R1/8 3809 08 10	14	15	32	25	0.040
8	R1/4 3809 08 13	14	14.5	34	25	0.045
	R1/4 3809 10 13	19	17.5	37.5	27.5	0.068
10	R3/8 3809 10 17	19	17.5	37.5	27.5	0.069

The body swivels for positioning purposes.

3809 Stud Elbow, Male NPT Thread

Stainless steel 316L, FKM

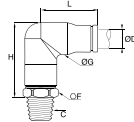

ØD	C	F	G	H	L	Kg
6	NPT1/8 3809 06 11	13	12.5	29	22.5	0.031
	NPT1/4 3809 06 14	14	12.5	29	22.5	0.036
8	NPT1/8 3809 08 11	14	15	34	24	0.040
	NPT1/4 3809 08 14	14	15	34	24	0.045
10	NPT1/4 3809 10 14	19	17.5	39.5	30	0.068
	NPT3/8 3809 10 18	19	17.5	39.5	30	0.071

The body swivels for positioning purposes.

3899 Stud Elbow, Male BSPP and Metric Thread

Stainless steel 316L, FKM

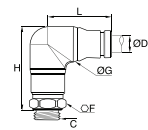

ØD	C	F	G	H	L	Kg
4	M5x0.8 3899 04 19	10	10	26	18	0.020
	G1/8 3899 04 10	13	10	27	19	0.022
	G1/4 3899 04 13	17	10	27	19	0.018
6	M5x0.8 3899 06 19	13	12	33	24	0.031
	G1/8 3899 06 10	6	12	33	24	0.031
	G1/4 3899 06 13	17	12	32	24	0.036
8	G1/8 3899 08 10	14	15	35	25	0.039
	G1/4 3899 08 13	17	15	35	25	0.044
	G3/8 3899 08 17	21	15	34.5	25	0.048
10	G1/4 3899 10 13	19	17	43	31	0.069
	G3/8 3899 10 17	21	17	42	31	0.072

The body swivels for positioning purposes.

3889 Compact Stud Elbow, Male BSPT Thread

Stainless steel 316L, FKM

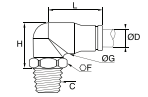

ØD	C	F	G	H	L	Kg
4	R1/8 3889 04 10	13	10	18	17	0.019
	R1/4 3889 04 13	17	10	19.5	16.5	0.018
6	R1/8 3889 06 10	13	12	21.5	20.5	0.025
	R1/4 3889 06 13	14	12	21.5	20.5	0.032
8	R1/8 3889 08 10	14	15	24	22	0.036
	R1/4 3889 08 13	14	15	24	22	0.036
10	R1/4 3889 10 13	17	17.5	28.5	27.5	0.058
	R3/8 3889 10 17	19	17.5	28.5	27.5	0.068
12	R1/4 3889 12 13	22	20	33.5	30	0.088
	R3/8 3889 12 17	22	20	33.5	30	0.090
	R1/2 3889 12 21	22	20	33.5	33	0.097

The body swivels for positioning purposes. Max. 20 bar

3889 Compact Male Stud Elbow, Male NPT Thread

Stainless steel 316L, FKM

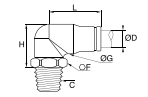

ØD	C	F	G	H	L	Kg
4	NPT1/8 3889 04 11	13	10	17.5	19	0.019
6	NPT1/8 3889 06 11	13	12.5	20	22.5	0.026
	NPT1/4 3889 06 14	14	12.5	20	22.5	0.033
8	NPT1/8 3889 08 11	13	15	25	24	0.036
	NPT1/4 3889 08 14	14	15	24	24	0.036
10	NPT1/4 3889 10 14	17	17.5	27.5	27.5	0.059
	NPT3/8 3889 10 18	19	17.5	28.5	26.5	0.068
12	NPT1/4 3889 12 14	22	20	31.5	32.5	0.086
	NPT3/8 3889 12 18	22	20	32.5	32.5	0.089
	NPT1/2 3889 12 22	22	20	27.5	32.5	0.098

The body swivels for positioning purposes. Max. 20 bar

LF 3800 Push-In Fittings / Stud Fittings

3889 Compact Stud Elbow, Male NPT Thread Inch

Stainless steel 316L, FKM

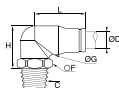

ØD	C		F	G	H	L	Kg
1/4	NPT1/8	3889 56 11	13	12	22	23	0.025
	NPT1/4	3889 56 14	14	12	22	23	0.032
3/8	NPT1/4	3889 60 14	17	17.5	28	30.5	0.058
	NPT3/8	3889 60 18	19	17.5	28	30.5	0.066
1/2	NPT1/4	3889 62 14	22	20	34	33	0.089
	NPT3/8	3889 62 18	22	20	34	33	0.089
	NPT1/2	3889 62 22	22	20	27	33	0.091

The body swivels for positioning purposes. Max. 20 bar.
5/32" (4 mm) and 5/16" (8 mm) also available.

3879 Compact Stud Elbow, Male BSPP Thread

Stainless steel 316L, FKM

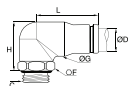

ØD	C		F	G	H	L	Kg
4	G1/8	3879 04 10	13	11	22	19	0.022
	G1/4	3879 04 13	17	11	20	19	0.027
6	G1/8	3879 06 10	13	12	24	24	0.029
	G1/4	3879 06 13	17	12	22	24	0.034
8	G1/8	3879 08 10	13	15	25	25	0.035
	G1/4	3879 08 13	17	15	25	25	0.039
	G3/8	3879 08 17	21	15	23	25	0.047
10	G1/4	3879 10 13	18	17	28.5	31	0.057
	G3/8	3879 10 17	21	17	28.5	31	0.065
12	G1/4	3879 12 13	17	20	33	33	0.077
	G3/8	3879 12 17	21	20	33	33	0.084
	G1/2	3879 12 21	24	20	30	33	0.096

The body swivels for positioning purposes. Max. 20 bar

3893 Stud Run Tee, Male BSPP and Metric Thread

Stainless steel 316L, FKM

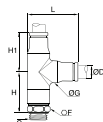

ØD	C		F	G	H	H1	L	Kg
8	G3/8	3893 08 17	21	15	27	25	35.5	0.094

The body swivels for positioning purposes.

LF 3800 push-in fittings allow connection with several types of Parker tubing shown in Chapter 3 of this catalogue, "Technical Tubing and Hose":

- PFA tubing
- Fluoropolymer tubing
- Polyethylene tubing
- Semi-rigid polyamide and flexible Crystal polyurethane tubing

LF 3800 Push-In Fittings / Tube-to-Tube Fittings

3806 Equal Tube-to-Tube Connector

Stainless steel 316L, FKM

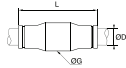

ØD		G	L	Kg
4	3806 04 00	10	29	0.009
6	3806 06 00	12	34	0.015
8	3806 08 00	15	36	0.019
10	3806 10 00	17.5	45	0.032
12	3806 12 00	20	46.5	0.040

3804 Equal Tee

Stainless steel 316L, FKM

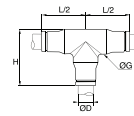

ØD		G	H	L/2	Kg
4	3804 04 00	10	22	19	0.020
6	3804 06 00	12	26	24	0.031
8	3804 08 00	15	29.5	25	0.040
10	3804 10 00	17.5	36.5	31	0.063
12	3804 12 00	20	40	33	0.087

3806 Equal Tube-to-Tube Connector

Inch

Stainless steel 316L, FKM

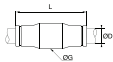

ØD		G	L	Kg
3/16	3806 55 00	11	31	0.010
1/4	3806 56 00	12	36	0.015
3/8	3806 60 00	17	47	0.030
1/2	3806 62 00	20	48	0.039

5/32" (4 mm) and 5/16" (8 mm) also available

3804 Equal Tee

Inch

Stainless steel 316L, FKM

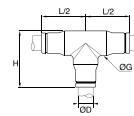

ØD		G	H	L/2	Kg
1/4	3804 56 00	12	30	23	0.031
3/8	3804 60 00	17	38	29	0.059
1/2	3804 62 00	20	43	33	0.088

5/32" (4 mm) and 5/16" (8 mm) also available

3802 Equal Elbow

Stainless steel 316L, FKM

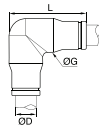

ØD		G	L	Kg
4	3802 04 00	10	21.5	0.015
6	3802 06 00	12	26.5	0.024
8	3802 08 00	15	29.5	0.031
10	3802 10 00	17.5	36.5	0.050
12	3802 12 00	20	40	0.071

3802 Equal Stud Elbow

Inch

Stainless steel 316L, FKM

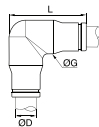

ØD		G	L	Kg
1/4	3802 56 00	12	29	0.023
3/8	3802 60 00	17	38	0.047
1/2	3802 62 00	20	43	0.071

5/32" (4 mm) and 5/16" (8 mm) also available

LF 3800 Push-In Fittings

3816 Equal Bulkhead Connector

Stainless steel 316L, FKM

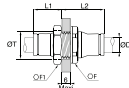

ØD		F	F1	L1	L2	ØT	Kg
4	3816 04 00	13	14	13.5	19.5	13	0.017
6	3816 06 00	17	17	16.5	21.5	14	0.027
8	3816 08 00	19	19	18	24	16	0.034
10	3816 10 00	22	22	21.5	27.5	21	0.048
12	3816 12 00	24	24	24	29	23	0.059

IP55 sealing

3826 Blanking Plug

Stainless steel 316L

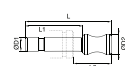

ØD1	ØD2		L	L1	L2	Kg
4	6	3826 04 00	25	17	11	0.003
6	8	3826 06 00	30.4	19.5	13.5	0.007
8	10	3826 08 00	33	20	14	0.014
10	12	3826 10 00	40	25	17	0.025
12	14	3826 12 00	43	26	19	0.039

3816 Equal Bulkhead Connector

Inch

Stainless steel 316L, FKM

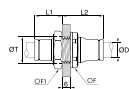

ØD		F	F1	L1	L2	ØT	Kg
3/16	3816 55 00	17	13	15	18	12.5	0.017
1/4	3816 56 00	19	17	19	21	15	0.027
3/8	3816 60 00	22	22	22	27	21	0.052
1/2	3816 62 00	27	27	25	28	25	0.076

IP55 sealing

5/32" (4 mm) and 5/16" (8 mm) also available

3800 Pre-Grooving Tool for Metallic Tubing

Treated steel

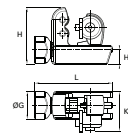

	G	H	H1	K	L	Kg
3800 70 00	25	51	13	36	70	0.326

This tool correctly pre-grooves 4-12 mm O.D. and 3/16"-1/2" O.D. stainless steel tubing, to ensure that the LF 3800 collet grips the tube securely.

3866 Push-In Reducer

Stainless steel 316L, FKM

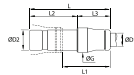

ØD1	ØD2		G	L	L1	L2	L3	Kg
4	6	3866 04 06	10	35	19	19	16	0.008
4	8	3866 04 08	10	34	17	20	14	0.011
6	8	3866 06 08	12	42	24	23	19	0.015
6	10	3866 06 10	12	41	19	25	16	0.019
8	10	3866 08 10	15	45	22.5	25	20	0.021
8	12	3866 08 12	15	43	20	26	17	0.025
10	12	3866 10 12	17	50	23	26	24	0.029

LF 6800 Push-In Fittings



Push-in fittings with reinforced cleanliness, for medical applications, bio-medical equipment, breathing systems, diagnosis devices, pharmaceutical process in accordance with the standards of the field of application.

Ø metric:
4 to 12 mm

Technical Characteristics

- **Compatible Fluids:** Breathing, neutral & pure medical gases. Other fluids: please consult us
- **Working Pressure:** Vacuum to 15 bar. Working pressure varies according to temperature (see below)
- **Working Temperature:** -10°C to +95°C

Tightening Torque (Metric & BSPP)	Thread	M5 x0.8	G1/8	G1/4	G3/8	G1/2
	daN.m		1.16	0.8	1.2	3

Reliable performance is dependent upon the type of fluid conveyed, component materials and tubing being used.

Use is guaranteed with a vacuum of 755 mm Hg (99% vacuum).

Advantages

- Compatibility with ASTM standards
- Recommended for O₂ applications and pure gases
- Bisphenol and phthalate-free

Component Materials

Silicone-free

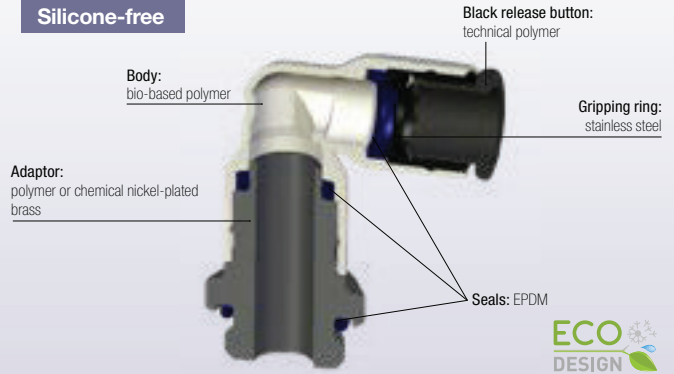

Regulations

- RoHS
 - REACH
- BAM:** Grease certification residue

6801 Stud Fitting, Male BSPP and Metric Thread

Chemical nickel-plated brass, EPDM

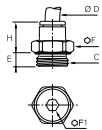

ØD	C		E	F	F1	H	Kg
4	M5x0.8	6801 04 19	3	8	2.5	14	0.003
	G1/8	6801 04 10	5.5	13	3	11.5	0.007
	G1/4	6801 04 13	5.5	16	3	10.5	0.011
6	M5x0.8	6801 06 19	3	10	2.5	16	0.005
	G1/8	6801 06 10	4.5	13	4	13	0.007
	G1/4	6801 06 13	5.5	16	4	12.5	0.011
8	G1/8	6801 08 10	4.5	13	5	20.5	0.011
	G1/4	6801 08 13	5.5	16	6	19.5	0.016
	G3/8	6801 08 17	5.5	20	6	18	0.022
10	G1/4	6801 10 13	5.5	16	7	23	0.018
	G3/8	6801 10 17	5.5	20	8	19.5	0.021
	G1/2	6801 10 21	7	24	8	18	0.033
12	G3/8	6801 12 17	5.5	20	9	27	0.029
	G1/2	6801 12 21	7	24	10	22.5	0.035

6814 Stud Fitting, Female BSPP Thread

Chemical nickel-plated brass, EPDM

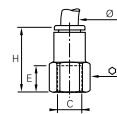

ØD	C		E	F	H	Kg
4	G1/8	6814 04 10	9.5	13	22.5	0.010
	G1/4	6814 04 13	9.5	13	24.5	0.011
6	G1/8	6814 06 10	13.5	16	28.5	0.017
	G1/4	6814 06 13	9.5	13	29	0.015
8	G1/4	6814 08 13	13.5	16	33	0.021
	G3/8	6814 08 17	14	19	34	0.025
	G1/4	6814 10 13	13.5	16	36	0.027
10	G3/8	6814 10 17	14	19	36	0.027
	G1/2	6814 10 21	19.5	24	41.5	0.048
12	G3/8	6814 12 17	14	19	40	0.033
	G1/2	6814 12 21	19.5	24	45.5	0.052

Applications Overview for Medical and Clean Room Environments



LF 6800 Push-In Fittings

6899 Stud Elbow, Male BSPP and Metric Thread

Bio-based polymer, chemical nickel-plated brass, EPDM

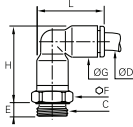

ØD	C		E	F	G	H	L	Kg
4	M5x0.8	6899 04 19	3.5	8	8.5	23	19	0.002
	G1/8	6899 04 10	4.5	13	8.5	22.5	19	0.006
	G1/4	6899 04 13	5.5	16	8.5	22.5	19	0.011
6	M5x0.8	6899 06 19	3.5	10	10.5	26.5	22.5	0.003
	G1/8	6899 06 10	4.5	13	10.5	26.5	22.5	0.006
	G1/4	6899 06 13	5.5	16	10.5	26.5	22.5	0.011
8	G1/8	6899 08 10	4.5	13	13.5	35	29.5	0.009
	G1/4	6899 08 13	5.5	16	13.5	33	29.5	0.012

The body swivels for positioning purposes.

6806 Equal Tube-to-Tube Connector

Bio-based polymer, EPDM

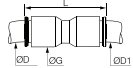

ØD	ØD1		G	L	Kg
4	4	6806 04 00	8.5	26.5	0.002
6	6	6806 06 00	10.5	30	0.004
8	8	6806 08 00	13.5	37	0.004
10	10	6806 10 00	16	42	0.009
12	12	6806 12 00	19	50.5	0.009

6802 Equal Elbow

Bio-based polymer, EPDM

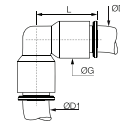

ØD	ØD1		G	L	Kg
4	4	6802 04 00	8.5	19	0.002
6	6	6802 06 00	10.5	24	0.004
8	8	6802 08 00	13.5	29	0.004
10	10	6802 10 00	16	34.5	0.005
12	12	6802 12 00	19	40.5	0.010

6804 Equal Tee

Bio-based polymer, EPDM

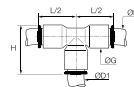

ØD	ØD1		G	H	L/2	Kg
4	4	6804 04 00	8.5	20	15.5	0.004
6	6	6804 06 00	10.5	23	18	0.006
8	8	6804 08 00	13.5	29	22.5	0.006
10	10	6804 10 00	16	34.5	26.5	0.009
12	12	6804 12 00	19	40	31	0.014

6840 Equal Single Y Piece

Bio-based polymer, EPDM

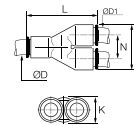

ØD	ØD1		H	K	L	N	Kg
4	4	6840 04 00	17.5	8.5	30	9	0.004
6	6	6840 06 00	21.5	10.5	36.5	11	0.008
8	8	6840 08 00	28	13.5	44.5	14.5	0.007
10	10	6840 10 00	33	16	53	17	0.010
12	12	6840 12 00	39	19	60.5	20	0.025

Complementary Products for LF 6800 Push-In Fittings

PU & PFA Tubing



Universal Customised Series Ball Valves, O₂ Applications



With Suffix 30

Cartridges for O₂ Applications



Upon Request Only

Function Fittings for O₂ Applications

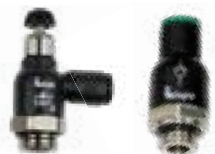

Upon Request Only

6816 Equal Bulkhead Connector

Bio-based polymer, EPDM

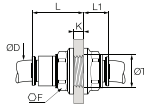

ØD		F	K max	L	L1	ØT min	Kg
4	6816 04 00	13	5.5	15.5	10.5	10.5	0.018
6	6816 06 00	15	8.5	20	10	12.5	0.004
8	6816 08 00	18	14.5	27	10.5	15.5	0.007
10	6816 10 00	22	14.5	30	13	18.5	0.012
12	6816 12 00	26	18.5	35	15.5	22.5	0.020

6866 Plug-In Reducer

Bio-based polymer, EPDM

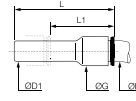

ØD	ØD1		G	L	L1	Kg
4	6	6866 04 06	8.5	38	23.5	0.004
6	8	6866 06 08	10.5	38	20	0.004
	10	6866 06 10	10.5	39	17.5	0.002
8	10	6866 08 10	13.5	48.5	28.5	0.009
	12	6866 08 12	13.5	48.5	24.5	0.004

6882 Equal and Unequal Plug-In Elbow

Bio-based polymer, EPDM

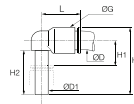

ØD	ØD1		G	H	H1	H2	L	Kg
4	4	6882 04 00	8.5	23	6	15.5	15	0.005
	6	6882 04 06	10.5	26.5	7	17	16.5	0.002
6	6	6882 06 00	10.5	26.5	7	17	17	0.003
	8	6882 06 08	13.5	33.5	8	21.5	22.5	0.004
8	8	6882 08 00	13.5	33.5	8	21.5	22.5	0.004

The reference in diameter 4mm is not grooved in standard version

6826 Blanking Plug

Bio-based polymer

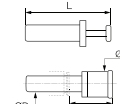

ØD		G	L	L1	Kg
4	6826 04 00	6	30	15.5	0.001
6	6826 06 00	8	33	16.5	0.001
8	6826 08 00	10	35	17.5	0.002
10	6826 10 00	12	42	21	0.003
12	6826 12 00	14	45	22	0.004

6888 Plug-In Equal Branch Tee

Bio-based polymer, EPDM

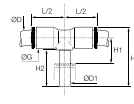

ØD	ØD1		G	H	H1	H2	L/2	Kg
4	4	6888 04 00	8.5	25	6	15.5	15	0.005
6	6	6888 06 00	10.5	28.5	7	17	16	0.006
8	8	6888 08 00	13.5	33.5	8	21.5	23	0.005

6883 Plug-In Equal Run Tee

Bio-based polymer, EPDM

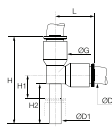

ØD	ØD1		G	H	H1	H2	L	Kg
4	4	6883 04 00	8.5	33	6	15.5	15	0.002
6	6	6883 06 00	10.5	38.5	7	17	18	0.002
8	8	6883 08 00	13.5	49	8	21.5	23	0.005

LF 6100 Push-In Fittings



Dedicated to lubrication and vacuum systems, this technology secures the connection and sealing performance at high pressures.

Ø metric:
4 to 10 mm

Technical Characteristics

- **Compatible Fluids:** Lubricants, compressed air, vacuum, other fluids and compatible gases
- **Working Pressure:** Vacuum to 60 bar
- **Working Temperature:** -40°C to +120°C

Max./Min. Tightening Torques (daN.m)	Thread	M6 x1	M8 x1	M8 x1.25	M10 x1	M12 x1	M14 x1.5	R 1/8	R 1/4
	Taper	0.2/0.6	0.2/1.2	0.2/1	0.2/1.2	0.2/2	0.5/1.5	0.2/1.0	0.5/1.5
	Parallel	-	0.6/1	-	0.6/1	1.8/2.2	-	-	-

Reliable performance is dependent upon the type of fluid conveyed, component materials and tubing being used.

Use is guaranteed with a vacuum of 755 mm Hg (99% vacuum).

Advantages

- Sealing guaranteed by 3 seals
- Tube cannot be disconnected without the use of a spanner
- Up to 60 bar, with rigid polymer or grooved metal tubing

Component Materials

Silicone-free

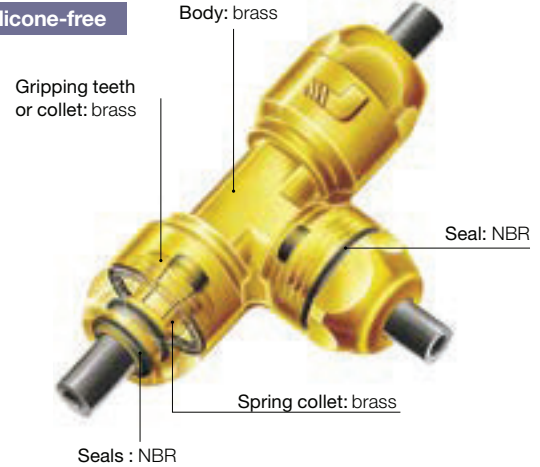

Regulations

- PED
- RoHS
- REACH

6105 Stud Fitting, Male BSPT and Taper Metric Thread

Brass, NBR

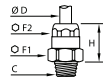

ØD	C		F1	F2	H	Kg
4	M6x1	6105 04 52	13	11	16.5	0.013
	M8x1	6105 04 56	13	11	14.5	0.012
	M8x1.25	6105 04 57	13	11	14.5	0.012
	M10x1	6105 04 60	13	11	14.5	0.015
	R1/8	6105 04 10	13	11	14.5	0.014
	R1/4	6105 04 13	14	11	12.5	0.018
6	M10x1	6105 06 60	17	14	16.5	0.024
	R1/8	6105 06 10	17	14	17.5	0.026
8	R1/4	6105 06 13	17	14	16.5	0.029
	M12x1	6105 08 65	19	21	24	0.041
10	M14x1.5	6105 10 71	22	24	26	0.005

6101 Stud Fitting, Male Parallel and Metric Thread

Brass, NBR

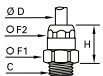

ØD	C		F1	F2	H	Kg
4	M10x1	6101 04 60	13	11	14	0.014
	M10x1	6101 06 60	17	14	17.5	0.026
6	M12x1	6101 06 65	17	14	16.5	0.025

6114 Stud Fitting, Female Metric Parallel Thread

Brass, NBR

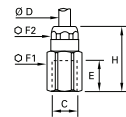

ØD	C		E	F1	F2	H	Kg
4	M8x1	6114 04 56	8	13	11	25.5	0.021
6	M8x1	6114 06 56	8	17	14	28.5	0.043

6179 Stud Elbow, Male BSPT and Taper Metric Thread

Brass, NBR

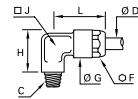

ØD	C		F	G	H	J	L	Kg
4	M6x1	6179 04 52	11	12.5	14.5	8	20	0.017
	M8x1	6179 04 56	11	12.5	14.5	8	20	0.018
	M8x1.25	6179 04 57	11	12.5	15	8	20	0.017
	M10x1	6179 04 60	11	12.5	15.5	8	20	0.019
	R1/8	6179 04 10	11	12.5	15	8	20	0.019
	R1/4	6179 04 13	11	12.5	17	10	20	0.030
6	M10x1	6179 06 60	14	16	18	10	25.5	0.033
	M12x1	6179 06 65	14	16	18	10	25.5	0.032
8	R1/8	6179 06 10	14	16	18	10	25.5	0.035
	R1/4	6179 06 13	14	16	19	10	25.5	0.036
8	M12x1	6179 08 65	17	19	17.5	12	30	0.054

LF 6100 Push-In Fittings

6106 Tube-to-Tube Connector

Brass, NBR

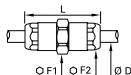

ØD		F1	F2	L	Kg
4	6106 04 00	13	11	34	0.025
6	6106 06 00	17	14	39	0.044
8	6106 08 00	19	17	46	0.069

6104 Equal Tee

Brass, NBR

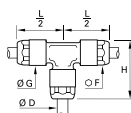

ØD		F	G	H	L/2	Kg
4	6104 04 00	11	12.5	26.5	20	0.034
6	6104 06 00	14	16	36	25.5	0.081
8	6104 08 00	17	19	39	30	0.111

0138 Copper Washer

Copper

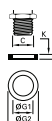

C		G1	G2	K	Kg
M6	0138 06 00	6.2	9.9	1	0.033
M8	0138 08 00	8.2	11.4	1	0.001
G1/8	0138 10 00	10.2	13.4	1	0.001
M12	0138 12 00	12.2	15.4	1.5	0.001
M14	0138 14 00	14.2	17.9	1.5	0.001
M16	0138 16 00	16.2	19.9	1.5	0.001
M18	0138 18 00	18.2	21.9	1.5	0.001
M20	0138 20 00	20.2	23.9	1.5	0.001
M22	0138 22 00	22.2	26.9	1.5	0.002
M24	0138 24 00	24.3	28.9	2	0.003
M26	0138 26 00	26.3	30.9	2	0.003
M30	0138 30 00	30.3	37.9	2	0.004
M36	0138 36 00	36.3	41.9	2	0.005
G1/4	0138 13 00	13.2	17.9	1.5	0.001
G3/8	0138 17 00	17.2	20.9	1.5	0.001
G1/2	0138 21 00	21.1	25.9	1.5	0.002
G3/4	0138 27 00	27.3	31.9	2	0.003
G1	0138 33 00	33.3	38.9	2	0.005
G1 1/4	0138 42 00	42.3	48.9	2	0.007
G2	0138 60 00	60.5	67.8	2.5	0.014

DIN 7603
ISO 65061

Accessories for Push-In Fittings



These accessories are designed to improve safety and circuit identification.

Ø metric: 4 to 16 mm
Ø inch: 1/4" to 1/2"

Technical Characteristics

- **Compatible Ranges:** LF 3000®, LIQUIfit®
- **Working Temperature:** -20°C to +95°C
- **Component Materials:** Tamper-proof safety clip, release button cover, clip: technical polymer

Advantages

Safety:

- Protection of operators and equipment
- Prevents accidental disconnection

Identification:

- 6 colour coding for fluid circuit identification
- Easy disconnection with dismantling too

3130 Tamper-Proof Safety Clip

Technical polymer

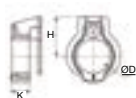

ØD	○	●	●	●	●	○	H	K	Kg
4	3130 04 01	3130 04 02	3130 04 03	3130 04 04	3130 04 05		6.6	3	0.001
6	3130 06 01	3130 06 02	3130 06 03	3130 06 04	3130 06 05	3130 06 10	7.8	3.1	0.001
8	3130 08 01	3130 08 02	3130 08 03	3130 08 04	3130 08 05	3130 08 10	9.5	4.3	0.001
10	3130 10 01	3130 10 02	3130 10 03	3130 10 04	3130 10 05	3130 10 10	10.8	4.2	0.002
12	3130 12 01		3130 12 03	3130 12 04	3130 12 05	3130 12 10	12.5	5.1	0.003
14	3130 14 01		3130 14 03				15	6	0.004
16			3130 16 03				27	1.7	0.004
1/4	3130 56 01		3130 56 03	3130 56 04		3130 56 10	8	3	0.001
3/8	3130 60 01						11	4	0.001
1/2			3130 62 03	3130 62 04			14	6	0.004

Installation Process

Tamper-Proof Safety Clip



Coloured Release Button Covers

Coloured release button covers can be mounted on LF 3000® and LIQUIfit® fittings, supplied fitted with manual release buttons.

5 colours are available and allows colour coding to be used throughout circuits.



Disconnection Tool

In cases where access is difficult, this tool can be particularly useful.



Clip Strips

Clips are also designed to fix LF 3000® fittings in series within a minimum of space.



CLIP Clip Strip for Tubing and Fittings

Technical polymer

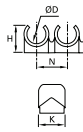

ØD		Number of Outlets	H	K	N	Kg
4	CLIP 04 00	8	9	13.5	10.5	0.007
6	CLIP 06 00	8	10.5	13	10.5	0.008
8	CLIP 08 00	7	12.5	10.5	12	0.007
10	CLIP 10 00	6	14	12	15	0.005
12	CLIP 12 00	5	16.5	14	16.5	0.009
14	CLIP 14 00	4	18	16	20.5	0.009

Delivered in boxes of 10 strips of the same diameter (complete with self-tapping screws of 95 mm length) These clips can be used with metric or inch tubing.

3000 70 Disconnection Tool

Treated steel

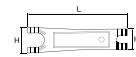

	H	H1	L	Kg
3000 70 00	25	20	96	0.021

For disconnecting LF 3000® tubing/fittings where access is difficult, we recommend the use of this disconnection tool.

3110 Coloured Release Button Covers

Technical polymer



ØD	○	●	●	●	●	Kg
4	3110 04 00	3110 04 02	3110 04 03	3110 04 04	3110 04 05	0.001
6	3110 06 00	3110 06 02	3110 06 03	3110 06 04	3110 06 05	0.001
8	3110 08 00	3110 08 02	3110 08 03	3110 08 04	3110 08 05	0.001
10	3110 10 00	3110 10 02	3110 10 03	3110 10 04	3110 10 05	0.001
12	3110 12 00	3110 12 02	3110 12 03	3110 12 04	3110 12 05	0.001
14	3110 14 00	3110 14 02	3110 14 03	3110 14 04		0.002
1/4		3110 56 02	3110 56 03	3110 56 04		0.001
3/8	3110 60 00			3110 60 04	3110 60 05	0.001

0605 Fluoropolymer Tape

FKM



Kg

0605 12 12	0.012
-------------------	-------

Can be used for temperatures from - 250°C to +260°C.
Chemically inert and resistant to gases, acids, solvents, hydrocarbons, oils, alkalines, steam etc.
Non-toxic, waterproof, self-lubricating. In accordance with CFR21. Can be used on all materials.
Used to facilitate the preparation of leak-free threaded joints.
Supplied on a reel, length = 12 m, width = 12.7 mm, thickness 0.08 mm.

Flow Control Regulators

Blocking Fittings

Piloted Non-Return Valves

Metal Quick Exhaust Valves

Non-Return Valves

LIQUIfit® Non-Return Valves

Soft Start Fittings

Pressure Regulators

Pneumatic Sensor Fittings

Snap Fittings

Manually-Operated Valves





Silencers



FUNCTION FITTINGS

Function Fittings











	Materials	Fluids	Maximum Pressure (bar)	Temperature		Performance in Aggressive Environments		Page
				Min.	Max.	Mechanical	Chemical	
Function Fittings								
Polymer Flow Control Regulators 	Technical polymer/nickel-plated brass/NBR	Compressed air	10	0°C	+70°C	Good	Moderate	92
Metal Flow Control Regulators, Brass 	Treated brass/nickel-plated brass/NBR	Compressed air	10	-25°C	+70°C	Excellent	Moderate	96
Metal Flow Control Regulators, Stainless Steel 	Stainless steel 316L/FKM	Compressed air	40	-15°C	+120°C	Excellent	Excellent	99
Blocking Fittings 	Nickel-plated brass/NBR	Compressed air	10	-20°C	+70°C	Excellent	Good	111
Piloted Non-Return Valves 	Technical polymer/nickel-plated brass/NBR	Compressed air	10	-5°C	+60°C	Good	Moderate	113
Metal Quick Exhaust Valves 	Nickel-plated brass, aluminium, stainless steel/PU-FKM	Compressed air	10	-20°C	+70°C	Excellent	Excellent	115
Polymer Non-Return Valves 	Technical polymer/nickel-plated brass/NBR	Compressed air	10	0°C	+70°C	Good	Moderate	117
Adjustable Non-Return Valves 	FDA chemical plated brass/NBR-FKM	Compressed air	12	-20°C	+80°C	Excellent	Excellent	119
LIQUIfit® Non-Return Valves 	POM/EPDM	Compressed air, drinkable water, treated water, beverages	10	0°C	+65°C	Good	Moderate	121
Stainless Steel Non-Return Valves 	Stainless steel/FKM	Many fluids	40	-20°C	+180°C	Excellent	Excellent	122
Soft Start Fittings 	Polymer nickel-plated brass/NBR	Compressed air	10	-15°C	+60°C	Good	Good	123
Pressure Regulators 	Polymer nickel-plated brass/NBR	Compressed air	10	-5°C	+60°C	Good	Good	125

	Materials	Fluids	Maximum Pressure (bar)	Temperature		Performance in Aggressive Environments		Page
				Min.	Max.	Mechanical	Chemical	
Pneumatic Sensor Fittings 	Polymer, treated brass, NBR	Compressed air	8	-15°C	+60°C	Good	Good	127
Snap Fittings 	Polymer, nickel-plated brass, NBR	Compressed air	10	-20°C	+80°C	Excellent	Good	129
Manually-Operated Valves Manual Switch-Operated Valves 	Polymer, nickel-plated brass, NBR	Compressed air	10	-10°C	+80°C	Excellent	Good	131
Manually-Operated Valves Sleeve Valves 	Nickel-plated brass, aluminium, NBR	Compressed air	16	-5°C	+70°C	Excellent	Good	131
Silencers 	Polymer, sintered bronze, nickel-plated brass, stainless steel 316L	Compressed air	12	-20°C	+180°C	Good	Moderate	133

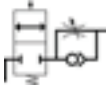
Selecting your Function Fitting

Protect Your System	Blocking Fittings	Maintain the load following an emergency stop of a pneumatic system.	Models 7880 - 7881 - 7883 - 7885 7886
	Soft Start Fittings	Increase the pressure gradually in order to protect it from potentially damaging shock when a pneumatic system is restarted.	Models 7860 - 7861 - 7870 - 7871
	Non-Return Valves	Allow compressed air or fluids to flow in one direction, and prevent it from flowing in the other. If the supply is accidentally shut off, the air can only escape in one direction.	Models 4890 - 4891 - 4892 - 4895 7930 - 7931 - 7932 - 7984 7985 - 7992 - 7994 - 7995 7996
	Piloted Non-Return Valves	Incorporate 3 functions into one product to protect your system: piloted non-return valve, flow control regulator and manual vent.	Models 7892 - 7894
Detect End of Cylinder Rod Stroke	Pneumatic Sensor Fittings	Detect the back pressure drop at the end of stroke to produce a signal (pneumatic or electronic) to allow reciprocation.	Models 7818 - 7828
Control and Improve the Performance of Your System	Pressure Regulators	Regulate and stabilise the pressure at a maximum determined value whatever the upstream pressure.	Models 7300
	Quick Exhaust Valves	Increase the return speed of the cylinder by discharging the exhaust directly to atmosphere.	Models 7899 - 7970 - 7971
	Silencers	Reduce the noise levels whilst air is vented from a compressed air system.	Models 0670 - 0671 - 0672 - 0673 0674 - 0675 - 0676 - 0677
Working on Your System	Snap Fittings	Allow a circuit to be isolated without fully venting the system.	Models 7921 - 7926 - 7960 - 7961
	Manually-Operated Valves	Allow for repeated venting by simply moving the valve sleeve or the manually-operated valve lever.	Models 0669 - 7800 - 7801 - 7802

Symbols for Function Fittings

Regulating air flow		Regulating pressure by stabilising at a required value	
Blocking air circulation		Reducing pressure supply	
Blocking and regulating air flow		Progressive pressurising of circuits	
Controlling allows the passage of fluid in one direction and prevents it in the other		Isolating a circuit without venting the entire system	
Exhausting system and controlling pneumatic circuit supply		Regulating, blocking and venting to protect the system and individuals	
Detecting pressure drop			

Selecting Your Flow Control Regulator

The comprehensive range of Parker Legris Flow Control Regulators provides a solution for all flow regulation functions in a pneumatic system.

Select the model suited to your application according to:

5 Key Requirements

1.	Condition of Use	Standard applications	Technical polymer models
		Severe applications	Metal models
2.	Connection Options	On cylinder or threaded control valve	Models with BSPP, BSPT and metric threads Models with NPT threads on request
		On cylinder or control valve with push-in connection	Plug-in models
3.	Dimensions	Standard applications require full flow rate performance and compact overall dimensions	Compact models
		Small diameter cylinders require precise and accurate adjustment and minimum size	Miniature models
4.	Type of Adjustment	Precise adjustment with locking nut ensuring the setting remains fixed	Models with external adjustment
		Precise adjustment with screwdriver and protection against unwanted adjustment	Models with recessed adjustment
5.	Installation Configuration	Standard applications	Banjo models
		Tube output that can be positioned through 180° and swivels with the tube movement	Models with swivel outlet
		Cylinder where access is difficult or where another function fitting is installed in the cylinder port	In-line models

Flow Control Regulators



Available with technical polymer, nickel-plated brass or aluminium bodies, with external or recessed adjustment screws, Flow Control Regulators offer precise adjustment, accuracy and compactness.

Ø metric:
3 to 14 mm

Technical Characteristics

- **Compatible Fluids:** Compressed air
Other fluids: contact us
- **Working Pressure:** 1 to 10 bar
- **Working Temperature:** 0°C to +70°C
-25°C to +70°C (metal version)

Max. Tightening Torques (external adjustment screw)	Threads	M3 x0.5	M5 x0.8	G1/8	G1/4	G3/8	G1/2
	daN.m		0.06	0.16	0.8	1.2	3

Max. Tightening Torques (recessed adjustment screw)	Threads	-	M5 x0.8	G1/8	G1/4	G3/8	G1/2
	daN.m		-	0.1	0.4	0.5	0.6

Reliable performance is dependent upon the type of fluid conveyed and component materials being used.

Use is guaranteed with a vacuum of 755 mm Hg (99% vacuum).

You will find all the flow rate characteristic curves (to 6 bar) for Flow Control Regulators at the end of the chapter.

Regulations

- RoHS
- REACH
- PED

Component Materials

Silicone-free

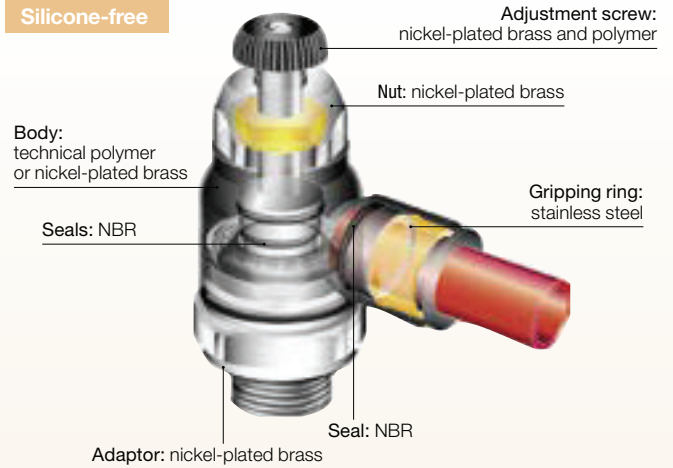

Advantages

Productivity:

- Higher maximum flow than standard regulators
- Optimal control of the cylinder rod speed

Accuracy:

- Precise adjustment for accurate flow regulation
- Long-term stability of flow

Ergonomics:

- External adjustment screw: easy to adjust ; Recessed adjustment screw: protects the adjustment mechanism
- Can be rotated 360° during assembly

Operation

The uni-directional models control the flow of air in one direction through an adjustable restrictor, while allowing full flow in the opposite direction. The bi-directional models control the flow of air in both directions.

A more precise and constant flow regulation is obtained when the regulator is fitted directly onto the cylinder.

Models with Recessed Adjustment

Uni-Directional (Exhaust Version)

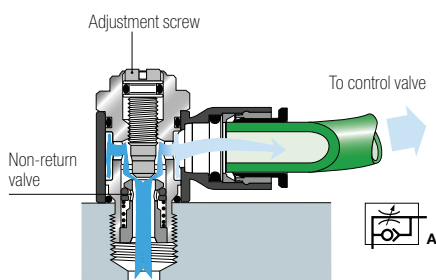

Uni-Directional (Supply Version)

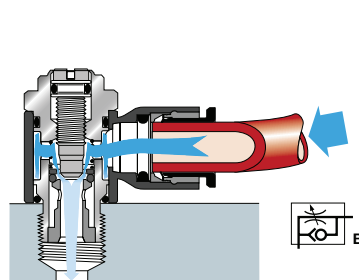

Bi-Directional Version

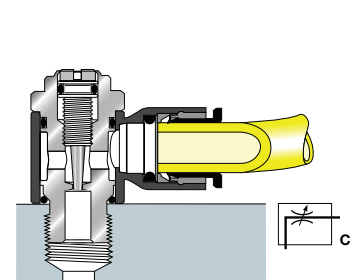

Flow Control Regulators

Models with External Adjustment

Uni-Directional (Exhaust Version)

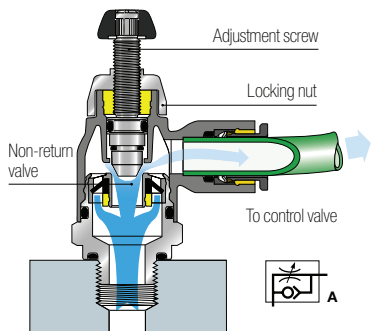

Uni-Directional (Supply Version)

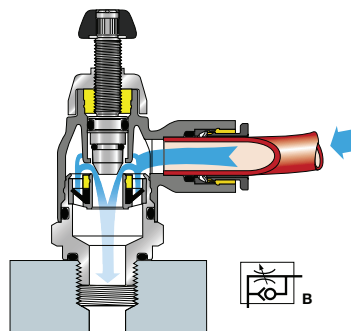

Bi-Directional Version

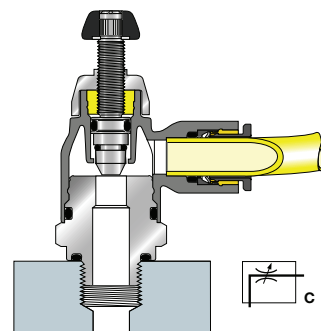

In-Line Models

Uni-Directional Version

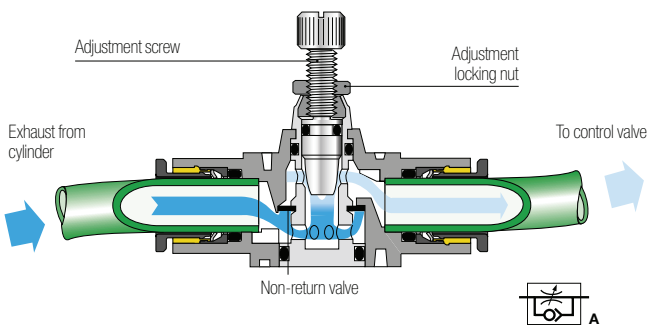

Bi-Directional Version

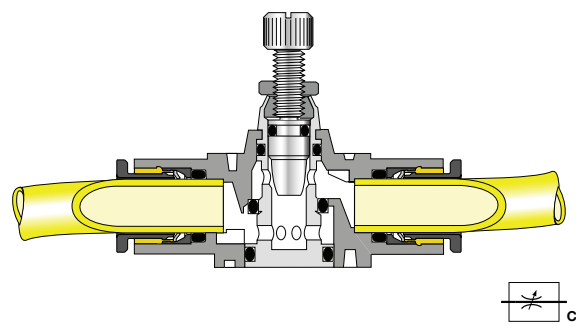

For instant visual identification, each Parker Legris flow control regulator version is identified by the related pneumatic symbol and by a letter:

- uni-directional regulation on exhaust: letter A
- uni-directional regulation on supply: letter B
- bi-directional regulation: letter C

7010 Flow Regulator Male BSPP and Metric Thread

Technical polymer, Nickel-plated brass, NBR

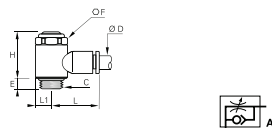

ØD	C		E	F	H	L	L1	Kg
4	M5x0.8	7010 04 19	4	8	17.5	17	5	0.006
	G1/8	7010 04 10	5	13	25	19	7	0.017
6	M5x0.8	7010 06 19	4	8	17.5	19	5	0.006
	G1/8	7010 06 10	5	13	25	21	7	0.018
	G1/4	7010 06 13	8	17	26.5	22	9.5	0.034
8	G1/8	7010 08 10	5	13	25	26	7	0.019
	G1/4	7010 08 13	8	17	26.5	27	9.5	0.035
	G3/8	7010 08 17	7.5	20	37.5	29	11	0.068
10	G1/4	7010 10 13	8	17	26.5	29	9.5	0.035
	G3/8	7010 10 17	7.5	20	37.5	31	11	0.067
	G1/2	7010 10 21	8	23	43	37	13.5	0.117
12	G3/8	7010 12 17	7.5	20	37.5	34.5	11	0.069
	G1/2	7010 12 21	8	23	43	37	13.5	0.108

7011 Flow Regulator Male BSPP and Metric Thread

Technical polymer, Nickel-plated brass, NBR

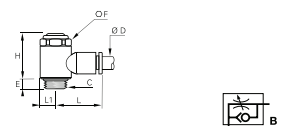

ØD	C		E	F	H	L	L1	Kg
4	M5x0.8	7011 04 19	4	8	17.5	17	5	0.006
	G1/8	7011 04 10	5	13	25	19	7	0.017
6	M5x0.8	7011 06 19	4	8	17.5	19	5	0.006
	G1/8	7011 06 10	5	13	25	21	7	0.018
	G1/4	7011 06 13	8	17	26.5	22	9.5	0.034
8	G1/8	7011 08 10	5	13	25	26	7	0.019
	G1/4	7011 08 13	8	17	26.5	27	9.5	0.035
	G3/8	7011 08 17	7.5	20	37.5	29	11	0.067
10	G1/4	7011 10 13	8	17	26.5	29	9.5	0.036
	G3/8	7011 10 17	7.5	20	37.5	31	11	0.068

Polymer Flow Control Regulators / With Recessed Adjustment

7012 Bi-Directional Flow Regulator Male BSPP and Metric Thread

Technical polymer, Nickel-plated brass, NBR

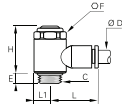

ØD	C		E	F	H	L	L1	Kg
4	M5x0.8	7012 04 19	4	8	17.5	17	5	0.006
	G1/8	7012 04 10	5	13	25	19	7	0.018
6	M5x0.8	7012 06 19	4	8	17.5	19	5	0.006
	G1/8	7012 06 10	5	13	25	21	7	0.019
8	G1/4	7012 06 13	8	17	26.5	22	9.5	0.035
	G1/8	7012 08 10	5	13	25	26	7	0.019
8	G1/4	7012 08 13	8	17	26.5	27	9.5	0.036
	G3/8	7012 08 17	7.5	20	37.5	29	11	0.071

7061 Compact Flow Regulator Supply, Male BSPP Thread

Technical polymer, Nickel-plated brass, NBR

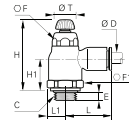

ØD	C		E	F	F1	H	H max	H1	L	L1	ØT	Kg
4	G1/8	7061 04 10	5	10	16	38	44	16	22	9	10	0.020
	G1/8	7061 06 10	5	10	16	38	44	16	22	9	10	0.020
6	G1/4	7061 06 13	5.5	10	16	36.5	42.5	15	22	9	10	0.021
	G1/8	7061 08 10	4.5	14	19	41.5	48	18	28	10.5	14	0.033
8	G1/4	7061 08 13	5.5	14	19	41.5	48	18.5	28	10.5	14	0.034
	G3/8	7061 08 17	5.5	14	23	41.5	48	17	28	11	14	0.033
10	G1/4	7061 10 13	5.5	17	23	45.5	53.5	20	31.5	12.5	17	0.053
	G3/8	7061 10 17	5.5	17	23	45.5	54	20	31.5	12.5	17	0.054
12	G1/2	7061 12 21	7.5	17	24	45.5	54	20	35	13	17	0.060

7060 Compact Flow Regulator Exhaust, Male BSPP Thread

Technical polymer, Nickel-plated brass, NBR

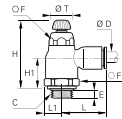

ØD	C		E	F	F1	H	H max	H1	L	L1	ØT	Kg
4	G1/8	7060 04 10	5	10	16	38	44	16	22	9	10	0.020
	G1/8	7060 06 10	5	10	16	38	44	16	22	9	10	0.020
6	G1/4	7060 06 13	5.5	10	16	36.5	42.5	15	22	9	10	0.020
	G1/8	7060 08 10	4.5	14	19	41.5	48	18	28	10.5	14	0.032
8	G1/4	7060 08 13	5.5	14	19	41.5	48	18.5	28	10.5	14	0.034
	G3/8	7060 08 17	5.5	14	19	41.5	48	17	28	11	14	0.034
10	G1/4	7060 10 13	5.5	17	23	45.5	53.5	20	31.5	12.5	17	0.053
	G3/8	7060 10 17	5.5	17	23	45.5	54	20	31.5	12.5	17	0.054
12	G3/8	7060 12 17	5.5	17	23	45.5	54	20	35	12.5	17	0.056
	G1/2	7060 12 21	7.5	17	24	45.5	54	20	35	13	17	0.058

7062 Bi-Directional Compact Flow Regulator, Male BSPP Thread

Technical polymer, Nickel-plated brass, NBR

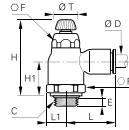

ØD	C		E	F	F1	H	H max	H1	L	L1	ØT	Kg
4	G1/8	7062 04 10	5	10	16	38	44	16	22	9	10	0.025
	G1/8	7062 06 10	5	10	16	38	44	16	22	9	10	0.025
6	G1/4	7062 06 13	5.5	10	16	36.5	42.5	15	22	9	10	0.025
	G1/8	7062 08 10	4.5	14	19	41.5	48	18	28	10.5	14	0.043
8	G1/4	7062 08 13	5.5	14	19	41.5	48	18.5	28	10.5	14	0.046
	G3/8	7062 08 17	5.5	14	19	41.5	48	17	28	11	14	0.042

7065 Compact Flow Regulator Exhaust, Male BSPT Thread

Technical polymer, Nickel-plated brass, NBR

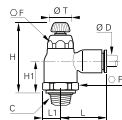

ØD	C		F	F1	H max	H min	H1	L	L1	ØT	Kg
6	R1/8	7065 06 10	10	16	42.5	36.5	15	22	8	10	0.021
	R1/8	7065 08 10	14	19	45	40	16.5	28	10.5	14	0.034
8	R1/4	7065 08 13	14	19	45	40	16.5	28	10.5	14	0.036
	R1/4	7065 10 13	17	23	51.5	43.5	18	31.5	12.5	17	0.053
10	R3/8	7065 10 17	17	23	51.5	43.5	18	31.5	12.5	17	0.055
	R1/2	7065 10 21	17	23	51.5	43.5	18	31.5	12.5	17	0.059
12	R1/4	7065 12 13	17	23	51.5	43.5	18	35	12.5	17	0.056
	R3/8	7065 12 17	17	23	51.5	43.5	18	35	12.5	17	0.059
	R1/2	7065 12 21	17	23	51.5	43.5	18	35	12.5	17	0.064

Pre-coated thread

7067 Bi-Directional Compact Flow Regulator, Male BSPT Thread

Technical polymer, Nickel-plated brass, NBR

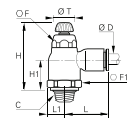

ØD	C		F	F1	H max	H min	H1	L	L1	ØT	Kg
4	R1/8	7067 04 10	10	16	42.5	36.5	14.7	22	9	10	0.025
	R1/8	7067 06 10	10	16	42.5	36.5	14.7	22	9	10	0.010
6	R1/4	7067 06 13	10	16	42.5	36.5	14.7	22	9	10	0.014
	R1/8	7067 08 10	14	19	45	40	16.5	28	10.5	14	0.034
8	R1/4	7067 08 13	14	19	45	40	16.5	28	10.5	14	0.036
	R3/8	7067 08 17	14	19	45	40	16.5	28	11	14	0.042

Pre-coated thread

Polymer Flow Control Regulators / With External Adjustment

7660 Miniature Flow Regulator Exhaust, Male BSPP and Metric Thread

Technical polymer, Nickel-plated brass, NBR

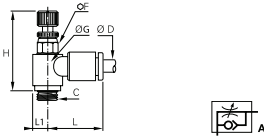

ØD	C		F	G	H max	H min	L	L1	Kg
3	M3x0.5	7660 03 09	6	9	26	23.5	17	4.5	0.007
	M5x0.8	7660 03 19	6	9	26	23.5	17	4.5	0.006
4	M3x0.5	7660 04 09	6	9	26	23.5	16.5	4.5	0.007
	M5x0.8	7660 04 19	6	9	26	23.5	17	4.5	0.006
	G1/8	7660 04 10	7	11.5	29.5	27	18	6	0.012
6	M5x0.8	7660 06 19	6	9	26	23.5	18	4.5	0.006
	G1/8	7660 06 10	7	11.5	29.5	27	18.5	6	0.012
	G1/4	7660 06 13	8	12	32.5	30	19	6	0.019
8	G1/8	7660 08 10	13	14	31	26.5	26	7	0.021
	G1/4	7660 08 13	16	19	34	29	27.5	9.5	0.033
	G3/8	7660 08 17	20	23	42	36	29	11.5	0.061

7665 Miniature Flow Regulator Exhaust, Male BSPT Thread

Technical polymer, Nickel-plated brass, NBR

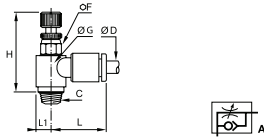

ØD	C		F	G	H max	H min	L	L1	Kg
4	R1/8	7665 04 10	7	11.5	27.5	25	18	6	0.012
	R1/8	7665 06 10	7	11.5	27.5	25	18.5	6	0.012
6	R1/4	7665 06 13	8	13.5	30	27.5	19	7	0.019
	R3/8	7665 06 17	17	13.5	34	31.5	19	7	0.025
	R1/8	7665 08 10	13	14	28.5	24	26	7	0.021
8	R1/4	7665 08 13	16	19	29	25	27.5	9.5	0.033
	R3/8	7665 08 17	20	23	36	30	29	11.5	0.061

Pre-coated thread

7669 Miniature Flow Regulator Supply, Male BSPP and Metric Thread

Technical polymer, Nickel-plated brass, NBR

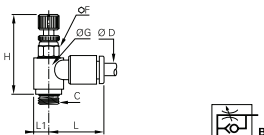

ØD	C		F	G	H max	H min	L	L1	Kg
3	M3x0.5	7669 03 09	6	9	26.5	24	17	4.5	0.008
	M5x0.8	7669 03 19	6	9	27.5	25	17	4.5	0.007
4	M5x0.8	7669 04 19	6	9	27.5	25	17	4.5	0.006
	G1/8	7669 04 10	7	11.5	31	28	18	6	0.012
6	M5x0.8	7669 06 19	6	9	27	23.5	18	4.5	0.007
	G1/8	7669 06 10	7	11.5	31	28	18.5	6	0.012
	G1/4	7669 06 13	8	12	34	30.5	19	6	0.019
8	G1/8	7669 08 10	13	14	32	29	26	7	0.021
	G1/4	7669 08 13	16	19	33.5	29.5	27.5	9.5	0.032
	G3/8	7669 08 17	20	23	41	37	29	11.5	0.063

7668 Miniature Flow Regulator Supply, Male BSPT Thread

Technical polymer, Nickel-plated brass, NBR

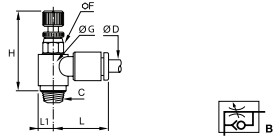

ØD	C		F	G	H max	H min	L	L1	Kg
4	R1/8	7668 04 10	7	11.5	28.5	25.5	18	6	0.011
6	R1/8	7668 06 10	7	11.5	29	24	18.5	6	0.012
	R1/4	7668 06 13	8	13.5	31	27	19	7	0.019
8	R1/8	7668 08 10	13	14	28.5	25	26	7	0.020
	R1/4	7668 08 13	16	19	30	26	27.5	9.5	0.032

Pre-coated thread

7662 Bi-Directional Miniature Flow Regulator, Male BSPP and Metric Thread

Technical polymer, Nickel-plated brass, NBR

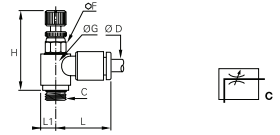

ØD	C		F	G	H max	H min	L	L1	Kg
4	M5x0.8	7662 04 19	6	9	26	23.5	17	4.5	0.007
	G1/8	7662 04 10	7	11.5	29.5	27	18	6	0.013
6	M5x0.8	7662 06 19	6	9	26	23.5	18	4.5	0.010
	G1/8	7662 06 10	7	11.5	29.5	27	18.5	6	0.013
	G1/4	7662 06 13	8	12	32.5	30	19	6	0.019

Polymer Flow Control Regulators / With External Adjustment

7040 Compact Flow Regulator Swivel Outlet Exhaust, Male BSPP Thread

Technical polymer, Nickel-plated brass, NBR

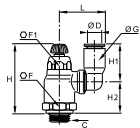

ØD	C	F	F1	G	H max	H min	H1	H2	L	Kg	
6	G1/8	7040 06 10	16	10	10.5	44	38	16	18	23.5	0.024
	G1/4	7040 06 13	16	10	10.5	42.5	36.5	16	16.5	23.5	0.023
	G1/8	7040 08 10	19	14	13.5	48	41.5	23	19	28	0.037
8	G1/4	7040 08 13	19	14	13.5	48	41.5	23	19.5	28	0.039
	G3/8	7040 08 17	19	14	13.5	48	41.5	23	17.5	28	0.020
	G1/4	7040 10 13	23	17	16	53.5	45.5	26.5	21	35	0.051
10	G3/8	7040 10 17	23	17	16	54	45.5	26.5	21.5	35	0.063
	G3/8	7040 12 17	23	17	19	54	45.5	30.5	21.5	38	0.066
12	G1/2	7040 12 21	24	17	19	54	45.5	30.5	21	38	0.071

7045 Compact Flow Regulator Swivel Outlet Exhaust, Male BSPT Thread

Technical polymer, Nickel-plated brass, NBR

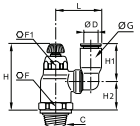

ØD	C	F	F1	G	H max	H min	H1	H2	L	Kg	
10	R3/8	7045 10 17	23	17	16	51.5	43.5	26.5	19	35	0.065
12	R3/8	7045 12 17	23	17	19	51.5	43.5	31	19	38	0.065

Pre-coated thread

7640 Miniature Swivel Outlet Flow Regulator Exhaust, Male BSPP and Metric Thread

Technical polymer, Nickel-plated brass, NBR

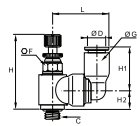

ØD	C	F	G	H max	H min	H1	H2	L	Kg	
4	M5x0.8	7640 04 19	6	8.5	26	23.5	14	6.5	19.5	0.011
	G1/8	7640 04 10	7	8.5	29.5	27	14	8	19.5	0.015
6	M5x0.8	7640 06 19	6	10.5	26	23.5	16	6.5	21	0.001
	G1/8	7640 06 10	7	10.5	29.5	27	16	8	20.5	0.015

7649 Miniature Swivel Outlet Flow Regulator Supply, Male BSPP and Metric Thread

Technical polymer, Nickel-plated brass, NBR

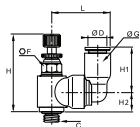

ØD	C	F	G	H max	H min	H1	H2	L	Kg	
4	M5x0.8	7649 04 19	6	8.5	27	24	14	6.5	19	0.015
6	M5x0.8	7649 06 19	6	10.5	27	24	16	6.5	21	0.008
	G1/8	7649 06 10	7	10.5	30.5	28	16	8.5	21.5	0.015

7770 In-Line One-Way Flow Regulator

Technical polymer, Nickel-plated brass, NBR

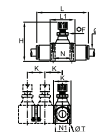

ØD	F	H max	H min	K	L	L1	N	N1	ØT	Kg	
4	7770 04 00	5	33.5	29.5	12	36	15	11	8	2.2	0.009
6	7770 06 00	8	44.5	40.5	17	51	23	17	11	3.2	0.024
8	7770 08 00	11	52.5	46.5	18.5	58	26	20	12.5	3.2	0.048
10	7770 10 00	14	61	53	24	73	33	26	16	4.2	0.097
12	7770 12 00	14	67.5	59	28	85	35	27.5	20	4.2	0.132

7772 Bi-Directional In-Line Flow Regulator

Technical polymer, Nickel-plated brass, NBR

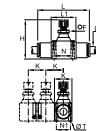

ØD	F	H max	H min	K	L	L1	N	N1	ØT	Kg	
4	7772 04 00	5	33.5	29.5	12	36	15	11	8	2.2	0.009
6	7772 06 00	8	44.5	40	17	51	23	17	11	3.2	0.024
8	7772 08 00	11	52.5	46.5	18.5	58	26	20	12.5	3.2	0.054

7776 Panel-Mountable In-Line One-Way Flow Regulator

Technical polymer, Nickel-plated brass, NBR

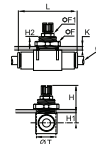

ØD	F	F1	H	H max	H1	H2	K	L	ØT	Kg	
4	7776 04 00*	14	38	41	6.5	11	6	36	10.5	0.015	
6	7776 06 00*	22	45.5	49	7.5	13.5	7	51	16.5	0.038	
8	7776 08 00	22	11	45.5	54	9	13.5	7	58	18.5	0.069
10	7776 10 00	30	14	54	62	11.5	13.5	7	73	24.5	0.136
12	7776 12 00	32	14	61	71	12.5	15.5	8	85	27.5	0.185

*Ultrafine adjustment

7771 In-Line One-Way Flow Regulator, Female BSPP Thread

Technical polymer, Nickel-plated brass, NBR

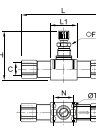

C	F	F1	H max	H min	L	L1	N	N1	ØT	Kg	
G1/8	7771 10 10	13	8	44.5	39.5	68.5	23	17	11	3.2	0.043
G1/4	7771 13 13	16	11	50	44	83	26	20	12.5	3.2	0.103
G3/8	7771 17 17	19	14	61	52	97	33	26	16	4.2	0.160
G1/2	7771 21 21	24	14	67.5	57.5	121	35	27.5	20	4.2	0.260

7000 Joining Clips

Technical polymer



ØD		Kg
4	7000 00 04	0.001
6-8	7000 00 05	0.005
10-12	7000 00 06	0.001

To be used with 7770,7771,7772 and 7776 series.

7020 Straight Flow Regulator Exhaust, Male BSPF Thread

Technical polymer, Nickel-plated brass, NBR

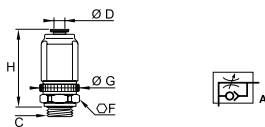

ØD	C	F	G	H max	H min	Kg	
8	G1/8	7020 08 10	24	27	52.5	46.5	0.110

7030 Compact Plug-In Flow Regulator, Exhaust

Technical polymer, Nickel-plated brass, NBR

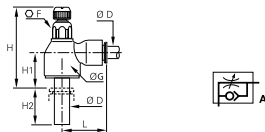

ØD	F	G	H max	H min	H1	H2	L	Kg
6	7030 06 00	10	16	41	35	14	22	0.013
8	7030 08 00	14	19	46.5	39.5	16	21.5	0.022
12	7030 12 00	17	23	51	43	17	35	0.044

7031 Compact Plug-In Flow Regulator, Supply

Technical polymer, Nickel-plated brass, NBR

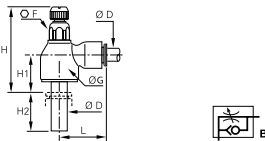

ØD	F	G	H max	H min	H1	H2	L	Kg
6	7031 06 00	10	16	41	35	14	22	0.013
8	7031 08 00	14	19	46.5	39.5	16	21.5	0.035

7630 Miniature Plug-In Flow Regulator, Exhaust

Technical polymer, Nickel-plated brass, NBR

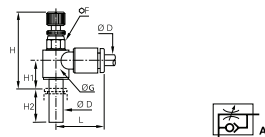

ØD	F	G	H max	H min	H1	H2	L	Kg
4	7630 04 00	6	9	28	25.5	9.5	15.5	0.007
6	7630 06 00	7	11.5	29	27.5	10.5	17	0.012

7631 Miniature Plug-In Flow Regulator, Supply

Technical polymer, Nickel-plated brass, NBR

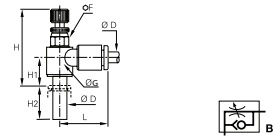

ØD	F	G	H max	H min	H1	H2	L	Kg
4	7631 04 00	6	9	28	25.5	9.5	15.5	0.007
6	7631 06 00	7	11.5	29	27.5	10.5	17	0.011

Metal Flow Control Regulators / With Recessed Adjustment

7130 Flow Regulator, Exhaust, Male BSPP and Metric Thread

Nickel-plated brass, NBR

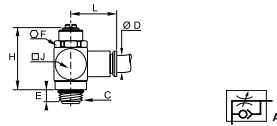

ØD	C		E	F	H	J	L	Kg
4	M5x0.8	7130 04 19	4	8	17	9	19	0.010
	G1/8	7130 04 10	5	13	29	15	20	0.037
6	M5x0.8	7130 06 19	4	8	17	9	24	0.013
	G1/8	7130 06 10	5	13	29	15	22	0.038
	G1/4	7130 06 13	8	17	31	18	24	0.062
8	G1/8	7130 08 10	5	13	29	15	25	0.042
	G1/4	7130 08 13	8	17	31	18	28	0.066
	G3/8	7130 08 17	7	20	40	21.5	29	0.109
10	G1/4	7130 10 13	8	17	31	18	30	0.075
	G3/8	7130 10 17	7	20	40	21.5	32	0.119
	G1/2	7130 10 21	8	23	53	28	34	0.227
12	G3/8	7130 12 17	7	20	40	22	36	0.064
	G1/2	7130 12 21	8	23	53	28	38	0.306

7140 Flow Regulator Exhaust, Male/Female BSPP and Metric Thread

Nickel-plated brass, NBR

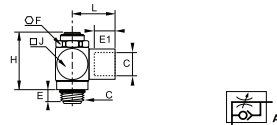

C			E	E1	F	H	J	L	Kg
M5x0.8	7140 19 19		4	4	8	21	9	11	0.009
G1/8	7140 10 10		5	8	13	32	15	17	0.039
G1/4	7140 13 13		8	12	17	39	18	24	0.073
G3/8	7140 17 17		7	12	20	47	21.5	27	0.124
G1/2	7140 21 21		8	15	23	61	28	31	0.238

7160 Flow Regulator with Brass Compression Fitting, Exhaust, Male BSPP Thread

Nickel-plated brass, NBR

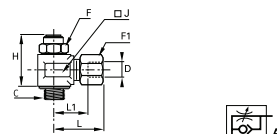

ØD	C		F	F1	H	J	L	L1	Kg
4	G1/8	7160 04 10	13	10	26	17	25.5	14.5	0.051
	G1/8	7160 06 10	13	13	26	17	25.5	14.5	0.054
6	G1/4	7160 06 13	17	13	31.5	22	28.5	17.5	0.101
	G1/8	7160 08 10	13	14	26	17	29.5	15.5	0.055
8	G1/4	7160 08 13	17	14	31.5	22	31	17	0.101
	G1/4	7160 10 13	17	19	31.5	22	35	19	0.117
10	G3/8	7160 10 17	20	19	44.5	22	37.5	19	0.190
	G1/2	7160 10 21	23	19	50	27	37.5	19	0.204
12	G1/2	7160 12 21	23	22	50	27	38	21.5	0.212

Metal Flow Control Regulators / With External Adjustment

7100 Compact Flow Regulator, Exhaust, Male BSPP Thread

Nickel-plated brass, NBR

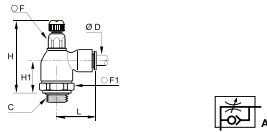

ØD	C		F	F1	H max	H min	H1	L	Kg
4	G1/8	7100 04 10	10	19	53	47	23	21	0.080
6	G1/8	7100 06 10	10	19	53	47	23	24.5	0.082
	G1/4	7100 06 13	10	19	53	47.5	23.5	24.5	0.085
8	G1/8	7100 08 10	14	19	55	50	24.5	29	0.097
	G3/8	7100 08 17	17	25	62	56	27	30.5	0.154
10	G1/4	7100 10 13	14	19	56	50	25	35	0.106
	G3/8	7100 10 17	17	25	62	56	27	35	0.157
12	G3/8	7100 12 17	17	25	62	56	27	38	0.198
	G1/2	7100 12 21	17	25	62	55	27	38	0.207
14	G1/2	7100 14 21	17	25	62	55	27	41	0.205

7101 Compact Flow Regulator, Supply, Male BSPP Thread

Nickel-plated brass, NBR

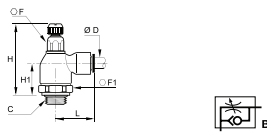

ØD	C		F	F1	H max	H min	H1	L	Kg
4	G1/8	7101 04 10	10	19	53	47	23	21	0.096
6	G1/8	7101 06 10	10	19	53	47	23	24.5	0.081
	G1/4	7101 06 13	10	19	53	47.5	23.5	24.5	0.084
8	G1/8	7101 08 10	14	19	55	50	24.5	29	0.097
	G3/8	7101 08 17	17	25	62	56	27	30.5	0.155

7680 Compact Flow Regulator, Exhaust, Male BSPP Thread

Nickel-plated brass, NBR

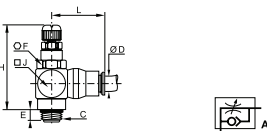

ØD	C		E	F	H max	H min	J	L	Kg
6	G1/8	7680 06 10	5	13	44	39	7.5	24.5	0.045
8	G1/8	7680 08 10	5	13	44	39	7.5	24.5	0.047
	G1/4	7680 08 13	8	17	47	41	9	27	0.076
10	G3/8	7680 10 17	7	20	60	50	11	34	0.133
12	G1/2	7680 12 21	8	23	77	65	14	36.5	0.165

7180 Miniature Flow Regulator Exhaust, Male BSPP and Metric Thread

Nickel-plated brass, NBR

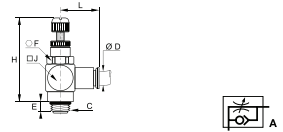

ØD	C		E	F	H max	H min	J	L	Kg
4	M5x0.8	7180 04 19	4	8	29	24	10	19	0.012
	G1/8	7180 04 10	5	13	44	39	15	20	0.041
6	M5x0.8	7180 06 19	4	8	29	24	10	24	0.015
	G1/8	7180 06 10	5	13	44	39	15	22	0.043
8	G1/8	7180 08 10	5	13	44	39	15	26	0.049

7110 Compact Flow Regulator Exhaust, Male/Female BSPP Thread

Nickel-plated brass, NBR

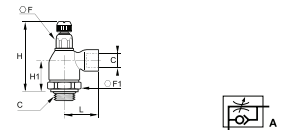

C		F	F1	H max	H min	H1	L	Kg
G1/8	7110 10 10	10	19	52.5	47	23	22.5	0.080
G1/4	7110 13 13	14	19	55.5	50.5	25	32	0.107
G3/8	7110 17 17	17	25	62	56	27	34.5	0.212
G1/2	7110 21 21	17	25	62	55	27	37.5	0.191

7111 Compact Flow Regulator Supply, Male/Female BSPP Thread

Nickel-plated brass, NBR

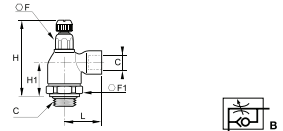

C		F	F1	H max	H min	H1	L	Kg
G1/8	7111 10 10	10	19	52.5	47	23	22.5	0.079
G1/4	7111 13 13	14	19	55.5	50.5	25	32	0.108

7190 Miniature Flow Regulator Exhaust, Male/Female BSPP and Metric Thread

Nickel-plated brass, NBR

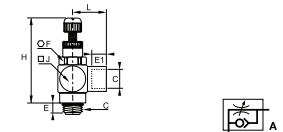

C		E	E1	F	H max	H min	J	L	Kg
M5x0.8	7190 19 19	4	4	8	29	24	10	11	0.012
G1/8	7190 10 10	5	8	13	44	39	15	17	0.044

Metal Flow Control Regulators / With External Adjustment

7170 Panel-Mountable In-Line Flow Regulator, Female BSPP and Metric Thread

Treated aluminium, NBR, brass

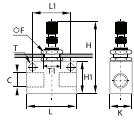

C		F	H max	H min	H1	K	L	L1	ØT	Kg
M5x0.8	7170 19 19	12	42	38	15	12	25	18	4.5	0.021
G1/8	7170 10 10	15	56	49	22	18	35	24.7	4.5	0.056
G1/4	7170 13 13	15	64	57	30	20	46	35	6.5	0.088
G3/8	7170 17 17	22	73	62	30	25	50	35	6.5	0.154
G1/2	7170 21 21	22	83	72	40	25	60	44	6.5	0.195

Metal Flow Control Regulators / Stainless Steel



With its 316L stainless steel body and adjustment screw, this range combines precise adjustment, accuracy and compactness for applications in environments with high mechanical or chemical constraints.

Technical Characteristics

Compatible Fluids	Compressed air 7822: all compatible fluids depending on whether FKM or PTFE seals are used
Working Pressure	7810-7812: 1 to 10 bar 7820: 1 to 16 bar 7822: 1 to 40 bar
Working Temperature	7810 – 7812: 0°C to +70°C 7820 – 7822: -15° to +120°C

Advantages

- Compatibility with aggressive, mechanical and chemical environments
- For food process applications:**
- Guarantees the integrity of the fluids conveyed
- Easy-to-clean

Operation

Exhaust Model with External Adjustment

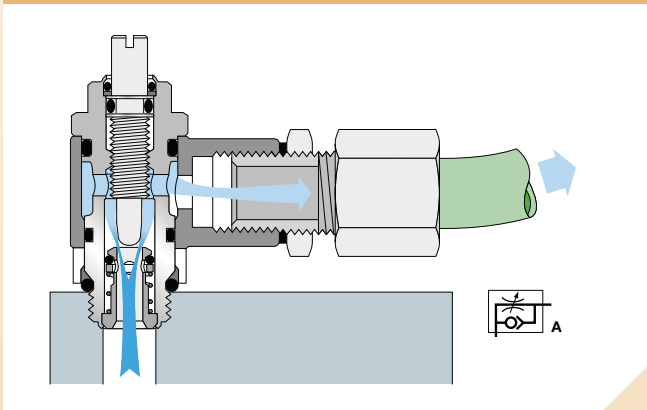

Bi-Directional Model with External Adjustment

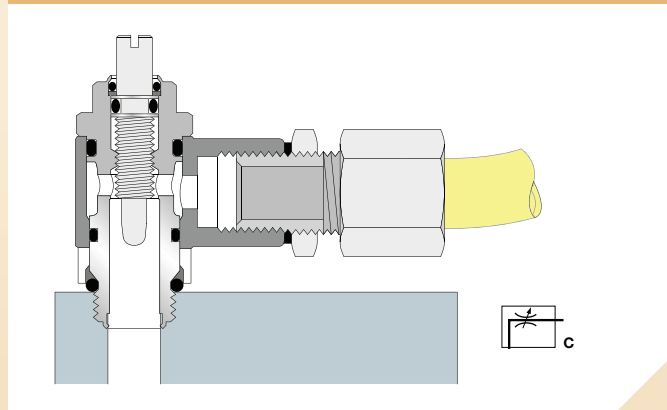

Component Materials



External Components

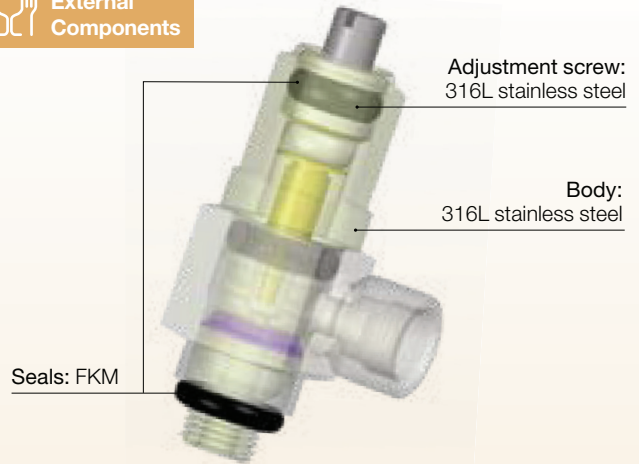

Regulations

- RoHS
- REACH
- PED
- FDA: 21 CFR 1935/2004

7810 Flow Regulator Exhaust, Male/Female BSPP and Metric Thread

Stainless steel 316L, FKM

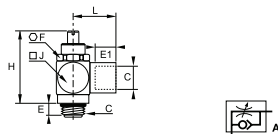

C		E	E1	F	H max	H min	J	L	Kg
M5x0.8	7810 19 19	4	4	8	26	22	9	11	0.011
G1/8	7810 10 10	6	8	13	38	32	15	17	0.039
G1/4	7810 13 13	9	12	17	40	35	18	24	0.072
G3/8	7810 17 17	8	12	20	53	43	22	27	0.126
G1/2	7810 21 21	9	15	23	71	60	28	31	0.261

7812 Bi-Directional Flow Regulator, Male/Female BSPP and Metric Thread

Stainless steel 316L, FKM

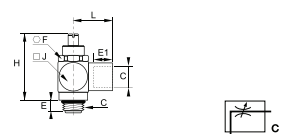



C		E	E1	F	H max	H min	J	L	Kg
M5x0.8	7812 19 19	4	4	8	26	22	9	11	0.011
G1/8	7812 10 10	6	8	13	38	32	15	17	0.040
G1/4	7812 13 13	9	12	17	40	35	18	24	0.074
G3/8	7812 17 17	8	12	20	53	43	22	24	0.125
G1/2	7812 21 21	9	15	23	71	60	28	31	0.261

Metal Flow Control Regulators / Stainless Steel

7820 In-Line One-Way Flow Regulator, Female BSP Thread

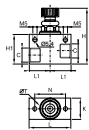
Stainless steel 316L, FKM



DN	C		H max	H min	H1	K	L	L1	N	ØT	Kg
7	G1/8	7820 00 10	52.5	47	30	20	40	20	30	20	0.174
7	G1/4	7820 00 13	52.5	47	30	20	40	20	30	20	0.164
9	G3/8	7820 00 17	65	56	35	25	50	25	36	20	0.285
12	G1/2	7820 00 21	65	58	35	25	50	25	36	20	0.305

7822 Bi-Directional In-Line Flow Regulator, Female BSP Thread

Stainless steel 316L, FKM

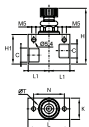

DN	C		H max	H min	H1	K	L	L1	N	ØT	Kg
7	G1/8	7822 00 10	52.5	48	30	20	40	20	30	20	0.176
7	G1/4	7822 00 13	52.5	48	30	20	40	20	30	20	0.164
9	G3/8	7822 00 17	65	58	35	25	50	25	36	20	0.289
12	G1/2	7822 00 21	87	76	40	30	60	30	42	30	0.265

Flow Characteristics (at 6 bar) for Flow Control Regulators



7010
7011
7012

7010

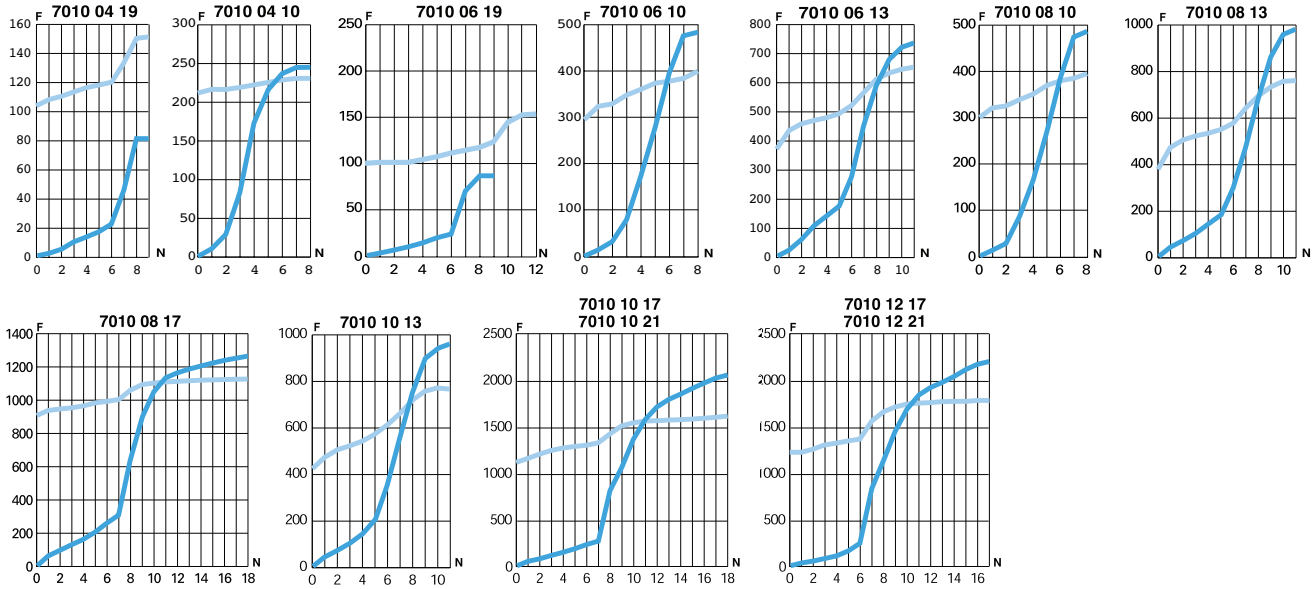

7011

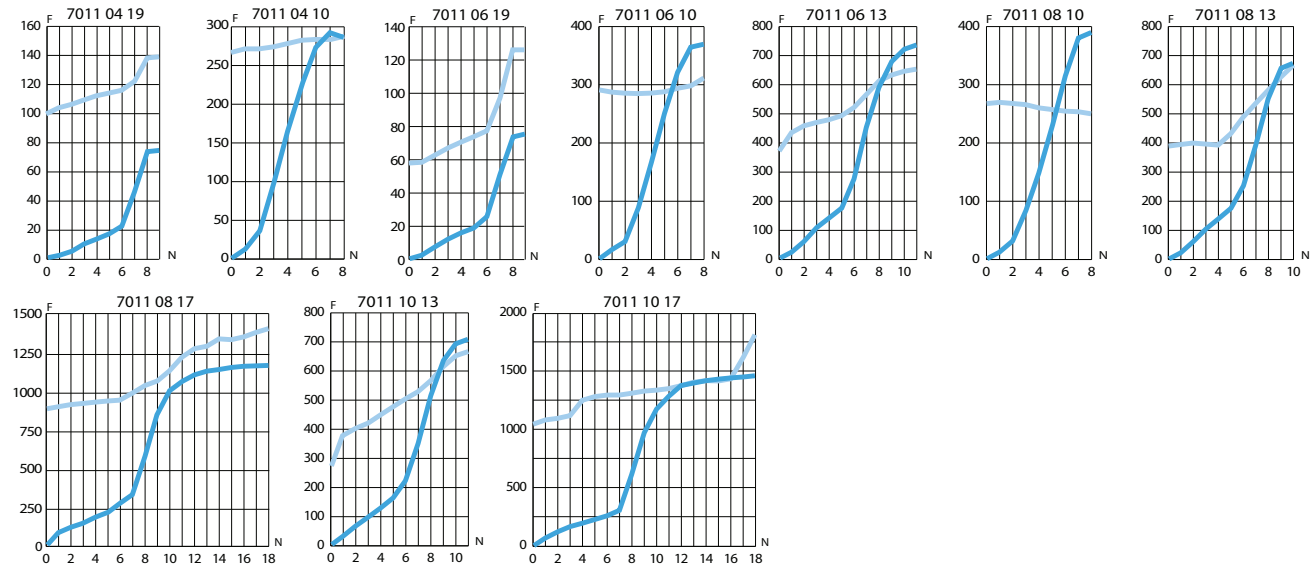

7012

Flow characteristics for model 7012:

- exhaust version (see model 7010, direction of adjustment)
- supply version (see model 7011, direction of adjustment)

6 bar

Direction of adjustment
 Return

F: Flow in NI/min

N: Number of turns

Flow Characteristics (at 6 bar) for Flow Control Regulators



7060
7061
7062

7060

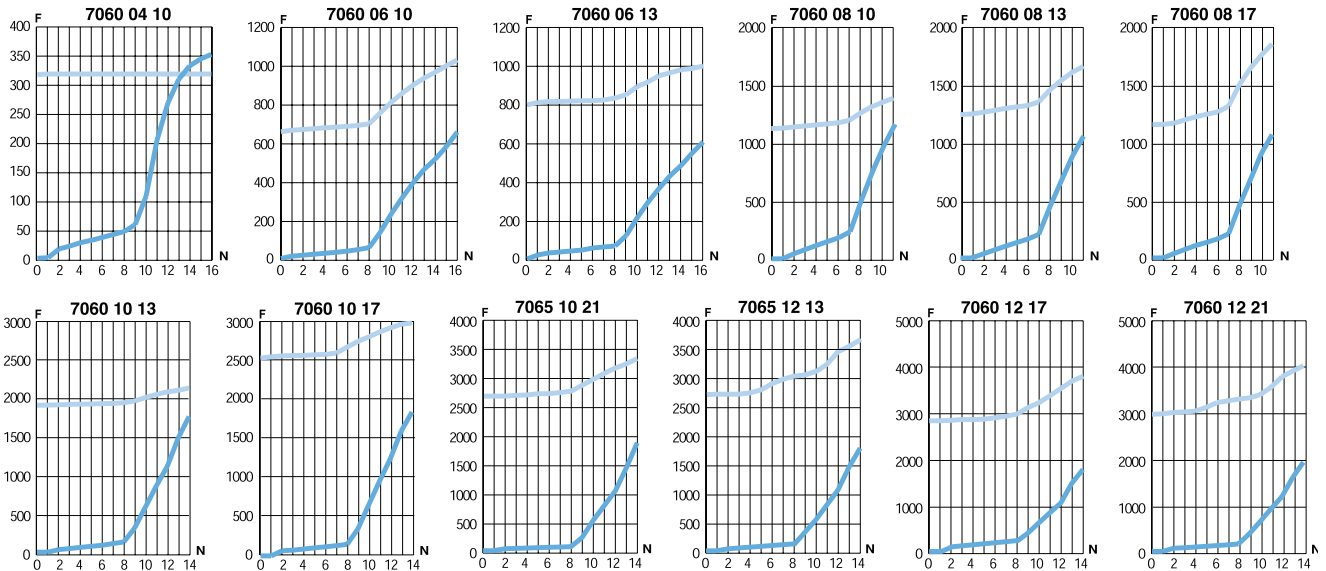

7061

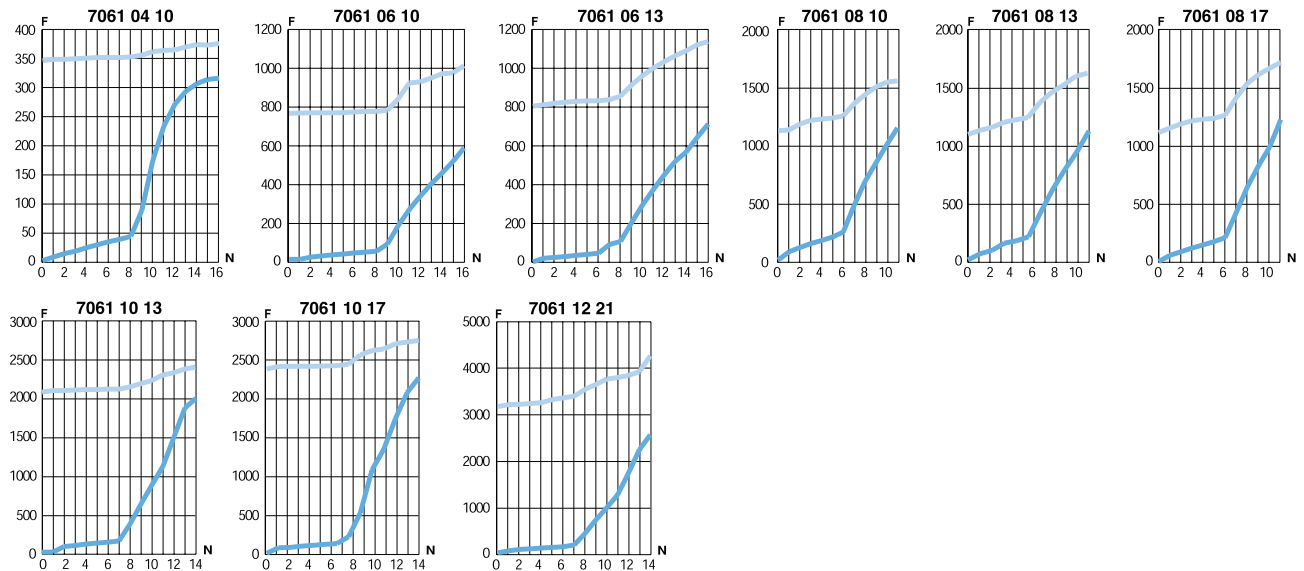

7062

Flow characteristics for model 7062:

- exhaust version (see model 7060, direction of adjustment)
- supply version (see model 7061, direction of adjustment)

Flow Characteristics (at 6 bar) for Flow Control Regulators



7660
7669
7662

7660

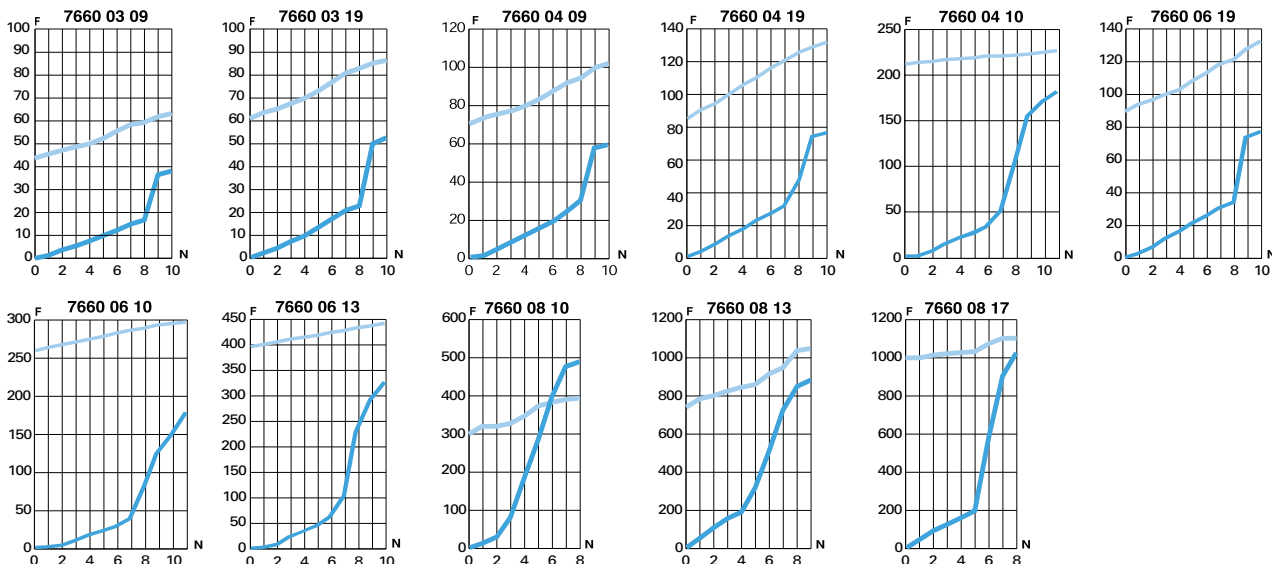

7669

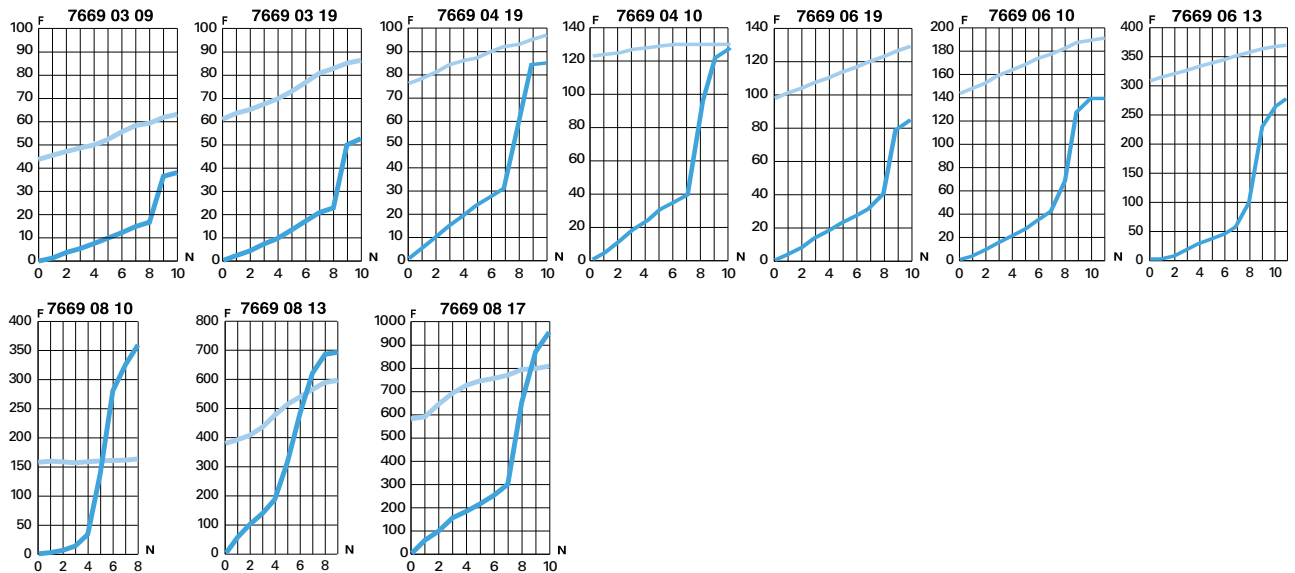

7662

Flow characteristics for model 7662:

- exhaust version: see model 7660, direction of adjustment
- supply version: see model 7669, direction of adjustment

6 bar

Direction of adjustment
 Return

F: Flow in NI/min

N: Number of turns

Flow Characteristics (at 6 bar) for Flow Control Regulators



7640
7649

7640

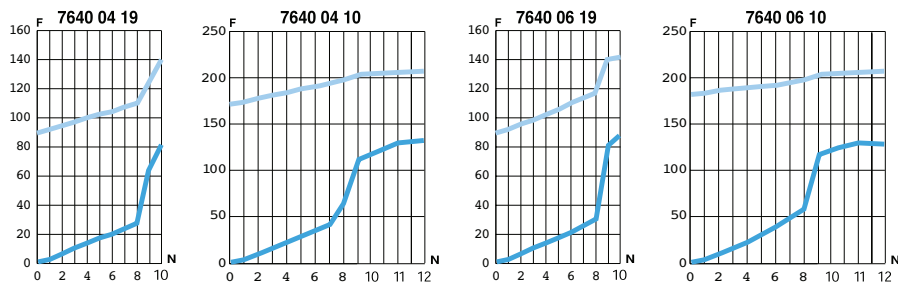

7649

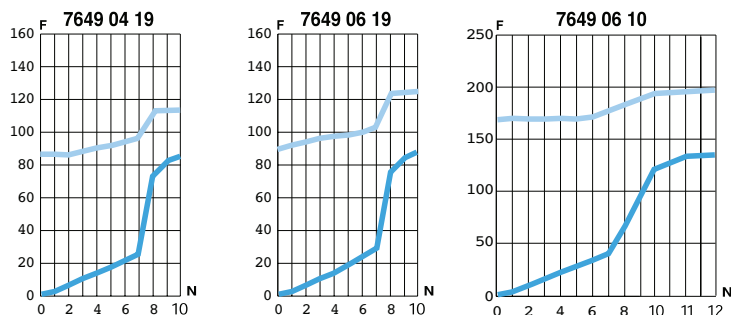

7771

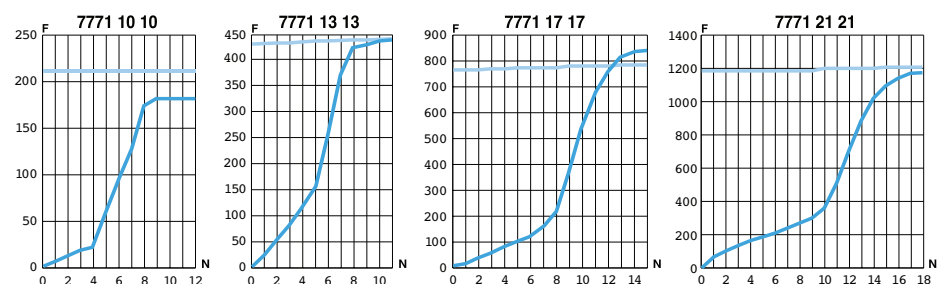

7020

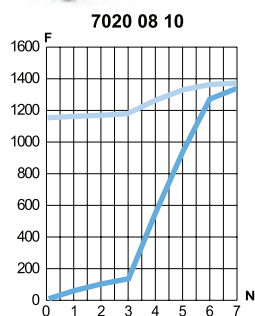

Flow Characteristics (at 6 bar) for Flow Control Regulators



7770

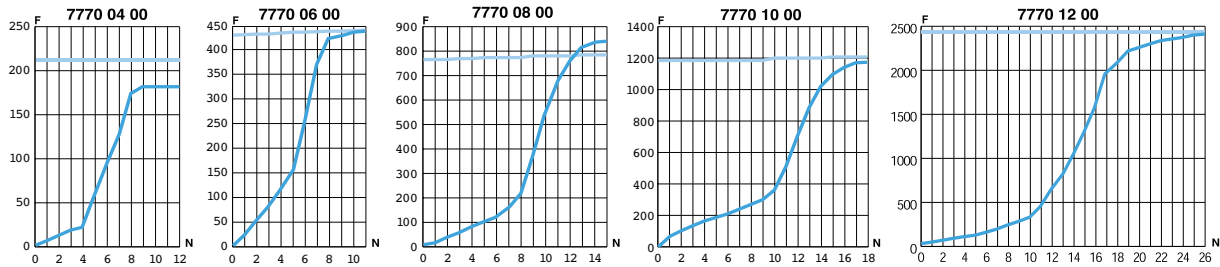

7776

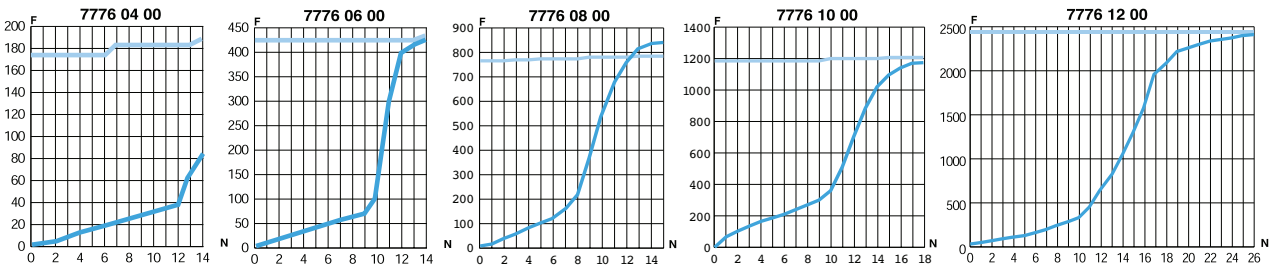

7030
7031

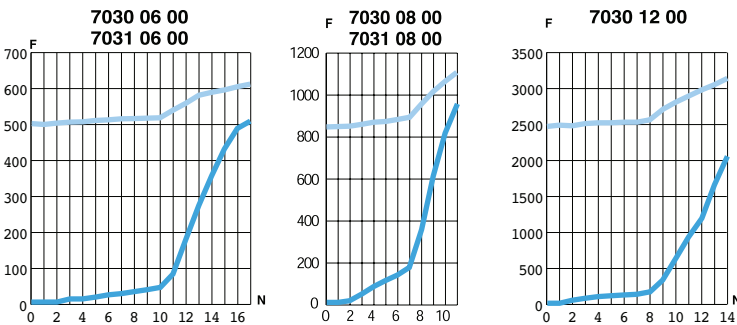

7630
7631

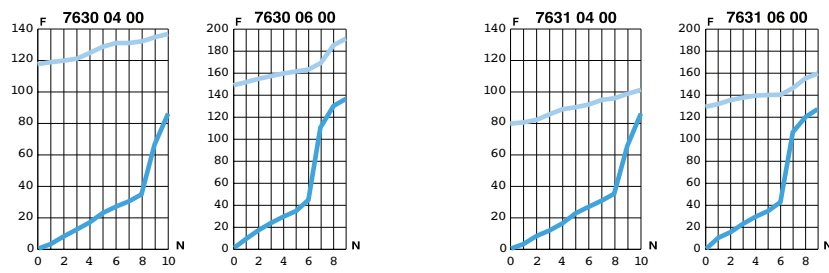

6 bar
 Direction of adjustment
 Return
F: Flow in NI/min
N: Number of turns

Flow Characteristics (at 6 bar) for Flow Control Regulators



7065
7067

7065

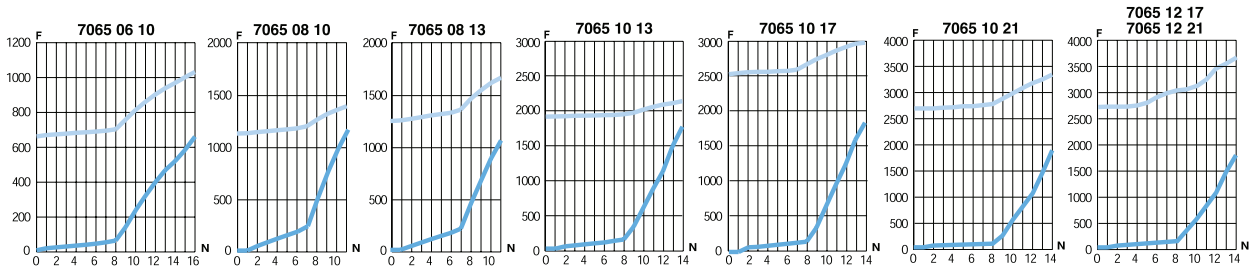

7067

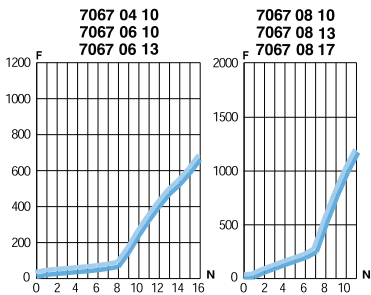

7665
7668

7665

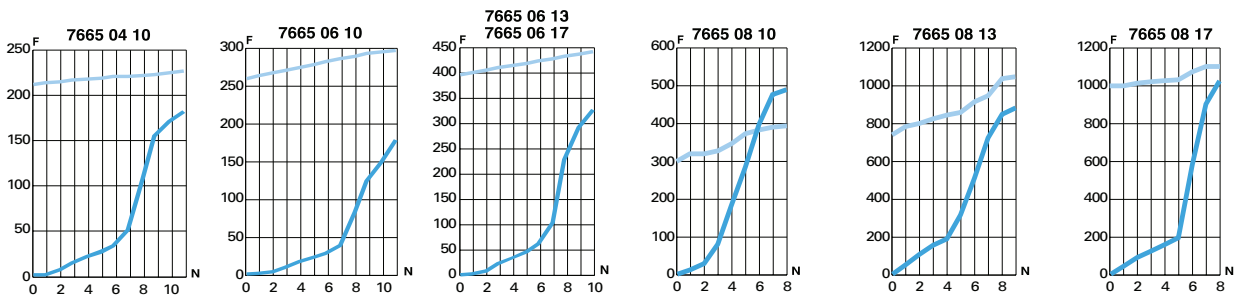

7668

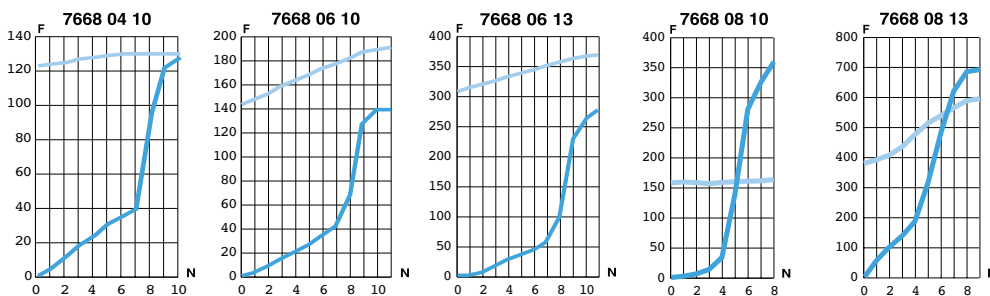

Flow Characteristics (at 6 bar) for Flow Control Regulators



7045

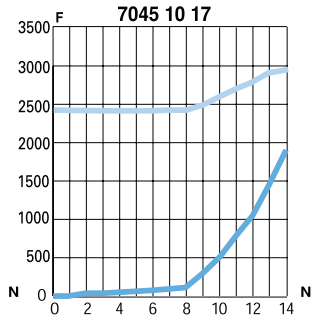

7130

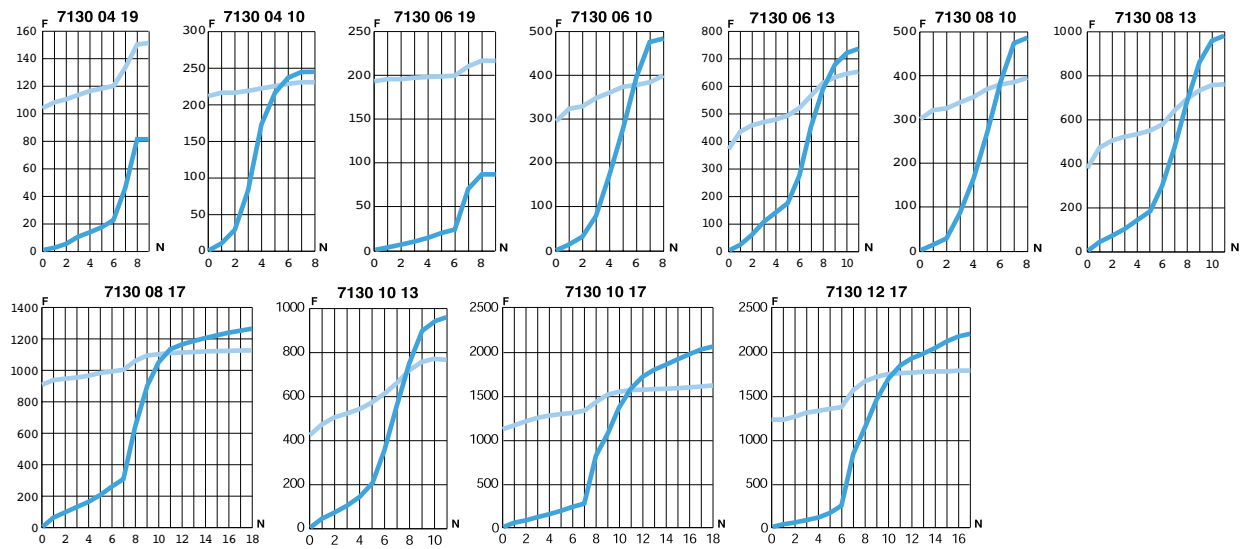

6 bar

Direction of adjustment
 Return

F: Flow in NI/min
N: Number of turns

Flow Characteristics (at 6 bar) for Flow Control Regulators



7140

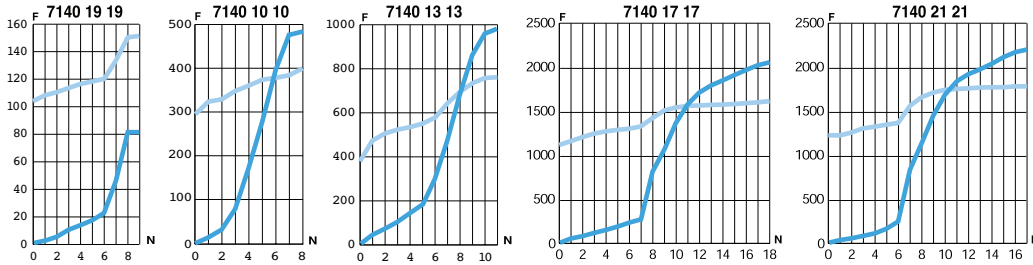

7160

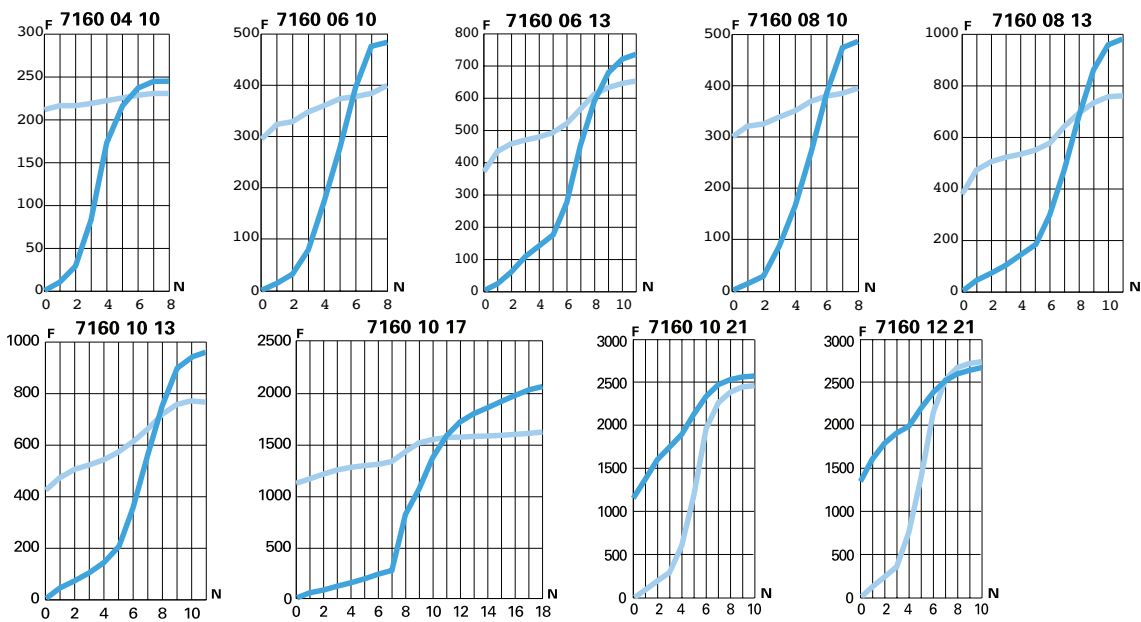

Flow Characteristics (at 6 bar) for Flow Control Regulators



7100
7101

7100

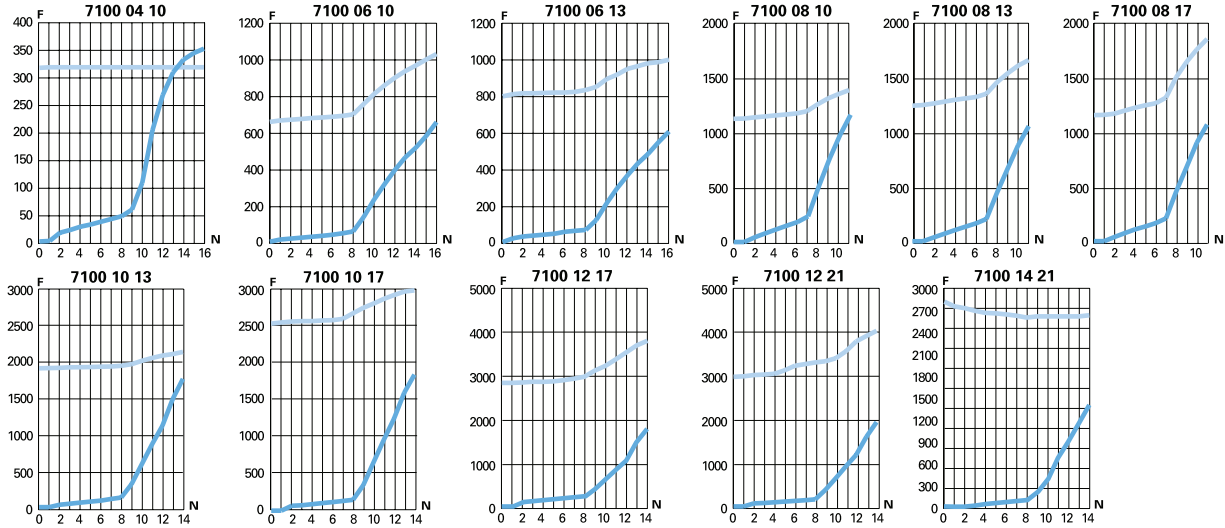

7101

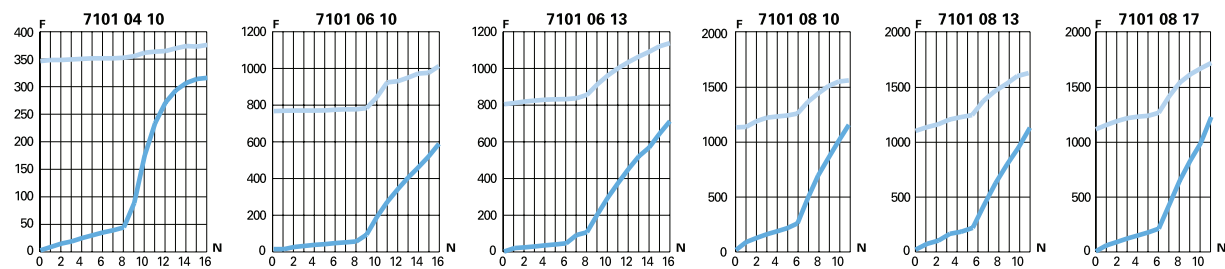

7680

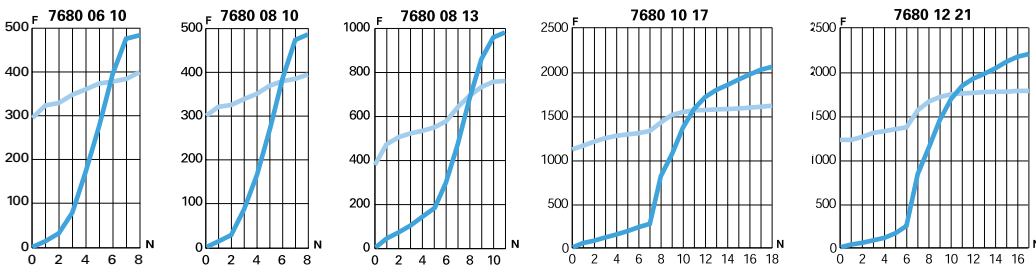

6 bar

Direction of adjustment
 Return

F: Flow in NI/min
N: Number of turns

Flow Characteristics (at 6 bar) for Flow Control Regulators



7180

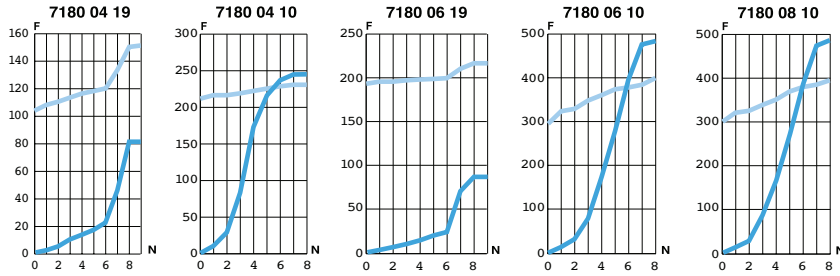

7110 7111

7110

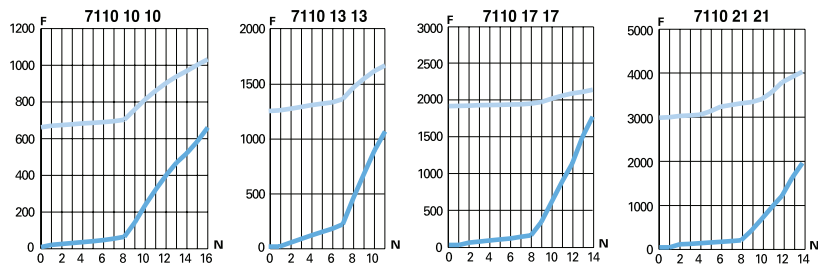

7111

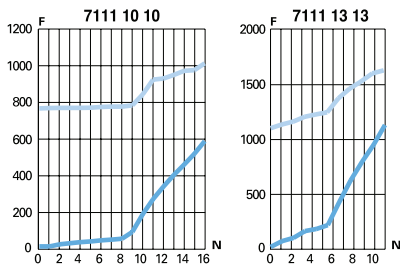

7170

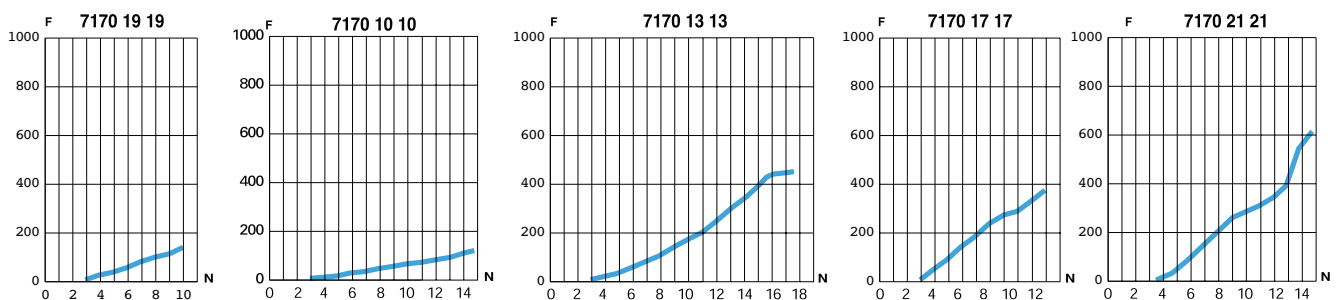

Blocking Fittings

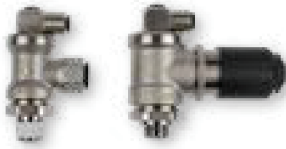

When the pilot signal is removed, these fittings ensure the safety of operators and protect the installation by cutting off the supply of compressed air in the circuit.

Ø metric:
4 to 12 mm

Technical Characteristics

- **Compatible Fluids:** compressed air
- **Working Pressure:** 1 to 10 bar
- **Working Temperature:** -20°C to +70°C
-25°C to +70°C (metal version)

Connection	Supply Flow 6 bar	Pilot and depilot threshold depending on supply pressure					
			2 bar	4 bar	6 bar	8 bar	10 bar
ØD 6 and 8 mm, threads G1/8, G1/4, R1/8, R1/4	650NI /min	Pilot Pressure	2.40	2.90	3.30	3.60	4.00
	650NI /min	Depilot Pressure	1.50	1.80	2.15	2.40	2.80
ØD 10 and 12 mm, threads G3/8, G1/2, R3/8, R1/2	1600NI /min	Pilot Pressure	2.70	3.20	3.50	3.80	4.10
	1600NI /min	Depilot Pressure	1.40	1.80	2.10	2.40	2.70

Reliable performance is dependent upon the type of fluid conveyed and component materials being used.

Use is guaranteed with a vacuum of 755 mm Hg (99% vacuum).

Advantages

- Mounted in pairs on a cylinder
- Compact size to fit into any configuration
- Proven endurance according to the requirements of DI 2006/42/EC (B10d = 10 000 000 cycles at a frequency of 1Hz, according to ISO 19973)
- Can be rotated 360° during assembly
- Spark resistance, for welding applications

Component Materials

Silicone-free

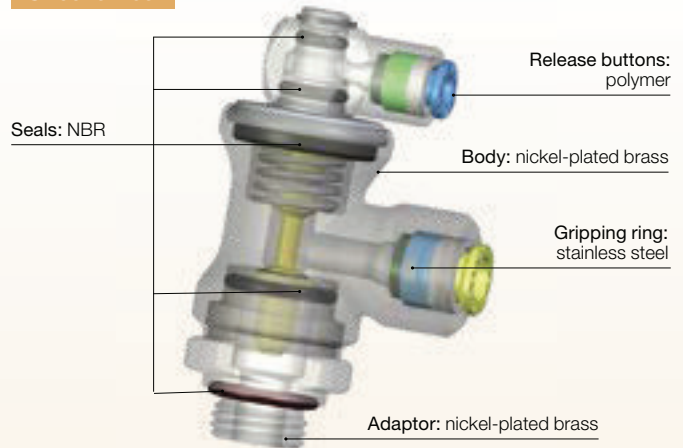

Regulations

- RoHS
- PED
- REACH
- B10d >110 millions of cycles

Operation

Cylinder in Operation (pilot signal active)

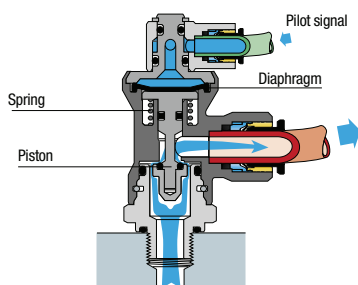

Pilot signal authorises movement

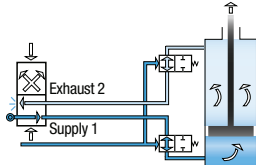

Cylinder Blocked (pilot signal removed)

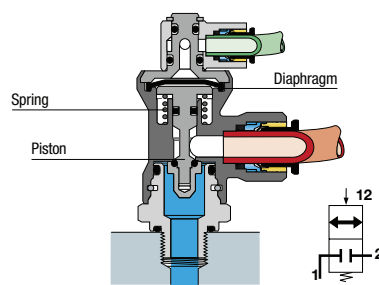

No signal blocks movement

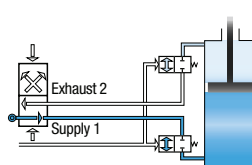

Installation

Mounted in pairs, blocking fittings are installed directly on the cylinder. Being fully orientable, they offer excellent flexibility in the design and installation of pneumatic circuits.

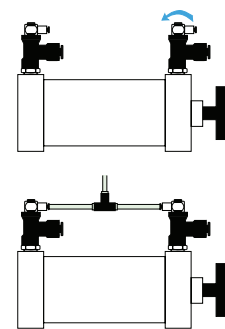

Blocking Fittings

7880 Blocking Fitting, Male BSPP Thread

Nickel-plated brass, NBR

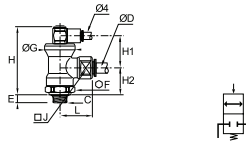

ØD	C		E	F	G	H	H1	H2	J	L	Kg
6	G1/8	7880 06 10	5.5	21	24	53	24.5	21	17	28	0.127
	G1/4	7880 06 13	6.5	21	24	53	24.5	21	17	28	0.130
8	G1/4	7880 08 13	6.5	21	24	53	24.5	21	17	28	0.124
	G3/8	7880 08 17	7.5	21	24	53	24.5	21	17	28	0.127
10	G3/8	7880 10 17	7.5	24	28	58	25	25	27	35	0.210
12	G1/2	7880 12 21	9	24	28	58	25	25	27	37.5	0.220

7881 Blocking Fitting, Male/Female BSPP Thread

Nickel-plated brass, NBR

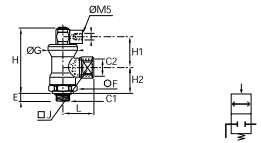

C1	C2		E	F	G	H	H1	H2	J	L	Kg
G1/8	G1/4	7881 13 10	5.5	21	24	53	24.5	21	17	25.5	0.119
G1/4	G1/4	7881 13 13	6.5	21	24	53	24.5	21	17	25.5	0.120
G3/8	G3/8	7881 17 17	7.5	24	28	58	25	25	27	34	0.208
G1/2	G1/2	7881 21 21	9	24	28	58	25	25	27	40	0.221

7885 Blocking Fitting, Male BSPT Thread

Nickel-plated brass, NBR

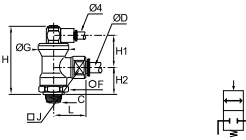

ØD	C		F	G	H	H1	H2	J	L	Kg
6	R1/8	7885 06 10	21	24	51.5	25	20	17	28	0.127
	R1/4	7885 06 13	21	24	51.5	25	20	17	28	0.131
8	R1/4	7885 08 13	21	24	51.5	25	20	17	28	0.126
	R3/8	7885 08 17	21	24	51.5	25	20	17	28	0.131
10	R3/8	7885 10 17	24	28	57	25	24	27	35	0.217
12	R1/2	7885 12 21	24	28	57	25	24	27	37.5	0.229

Pre-coated thread

7886 Blocking Fitting, Male/Female BSPT Thread

Nickel-plated brass, NBR

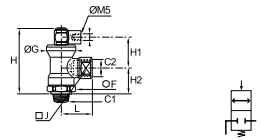

C1	C2		F	G	H	H1	H2	J	L	Kg
R1/8	R1/4	7886 13 10	21	24	51.5	25	20	17	26.5	0.121
R1/4	R1/4	7886 13 13	21	24	51.5	25	20	17	26.5	0.126
R3/8	R3/8	7886 17 17	24	28	57	25	24	27	34	0.225
R1/2	R1/2	7886 21 21	24	28	57	25	24	27	40	0.235

Pre-coated thread

7883 Blocker/Flow Regulator, Exhaust, Male BSPP Thread

Nickel-plated brass, technical polymer, NBR

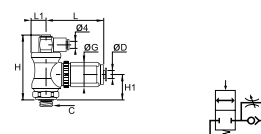

ØD	C		G	H	H1	L	L max	L1	Kg
4	G1/8	7883 04 10	21.5	53	21	46.5	52	12	0.166
	G1/8	7883 06 10	21.5	53	21	46.5	52	12	0.163
6	G1/4	7883 06 13	21.5	53	21	46.5	52	12	0.166
	G1/4	7883 08 13	27	57.5	24.5	54	60	14	0.252
8	G3/8	7883 08 17	27	57.5	24.5	54	60	14	0.254

Combination of blocking and flow regulation functions
Working temperature: 0 to 70°C

Piloted Non-Return Valves



Piloted non-return valves are designed to protect installations: if the compressed air supply is removed, they lock the air supply to the cylinder, thus maintaining it in position.

Ø metric:
6 to 12 mm

Technical Characteristics

- **Compatible Fluids:** compressed air
- **Working Pressure:** 1 to 10 bar
- **Working Temperature:** -5°C to +60°C
- **Cracking Pressure:** 0.3 bar

Advantages

- Mounted in pairs on a cylinder
- 3 functions in 1 compact product:
 - piloted non-return valve
 - flow control regulator
 - manual exhaust
- Vent saves time on restart after maintenance operations

Component Materials

Silicone-free

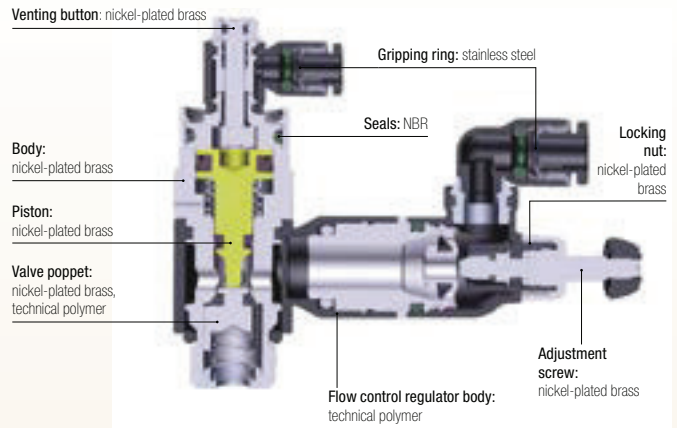

Regulations

- RoHS
- REACH
- PED

Operation

Normal Operation

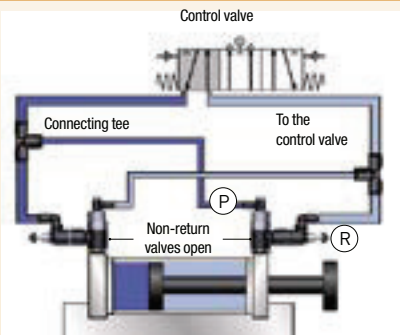

Pilot signal (P)
Regulation of cylinder rod speed (R)

Emergency Stop or Pressure Drop

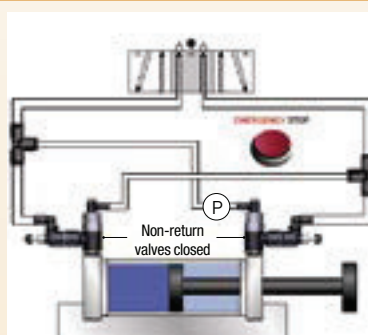

Drop/removal of pilot pressure (P) = cylinder rod locked

Venting Operation

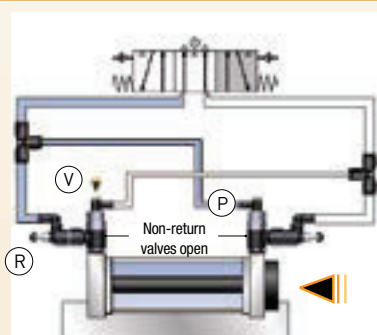

Venting (V) returns the cylinder rod to the start position, emptying the pressure chamber through the flow regulator (R) and pilot line (P)

Model	Pilot and depilot threshold					
		2 bar	4 bar	6 bar	8 bar	10 bar
G1/8	Pilot Pressure	1.2	1.72	2.44	2.96	3.56
	Depilot Pressure	0.56	0.96	1.12	1.76	2.12
G1/4	Pilot Pressure	0.92	1.52	2.12	2.68	3.28
	Depilot Pressure	0.64	1.16	1.68	2.16	2.64
G3/8	Pilot Pressure	1.12	1.84	2.56	3.32	4.08
	Depilot Pressure	0.64	1.04	1.44	1.84	2.36
G1/2	Pilot Pressure	1.04	1.60	2.12	2.76	3.88
	Depilot Pressure	0.76	1.28	1.76	2.20	2.72

Maximum Flow at 6 bar (NI/min)	7894 06 10	7894 06 13	7894 08 10	7894 08 13	7894 08 17	7894 10 17	7894 10 21	7894 12 21
Direction of Adjustment	250	475	240	585	875	940	1535	1560
Return	365	620	355	815	1085	1205	1860	1940

Piloted Non-Return Valves

7892 Piloted Non-Return Valve, Male BSPP Thread

Technical polymer, Nickel-plated brass, NBR



ØD	C		E	F	G	H	H1	H2	L	Kg
6	G1/8	7892 06 10	6	13	14	42	30	7	21	0.020
	G1/4	7892 06 13	9	17	18.5	45	32	9	23	0.042
8	G1/8	7892 08 10	6	13	14	42	29	9	25	0.020
	G1/4	7892 08 13	9	17	18.5	45	32	9	27	0.042
10	G3/8	7892 08 17	6	20	22.5	57	41	11	28	0.093
	G3/8	7892 10 17	6	20	22.5	57	41	11	31	0.144
12	G1/2	7892 10 21	10	24	28	63	47	16	36	0.109
	G1/2	7892 12 21	10	24	28	63	47	16	36	0.150

7894 Piloted Non-Return Valve with Flow Regulator Exhaust, Male BSPP Thread

Technical polymer, Nickel-plated brass

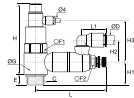

ØD	C		E	F1	F2	G	H	H1	H2	H3	L	L max	L1	Kg
6	G1/8	7894 06 10	6	13	8	14	46	7	24	31	48.5	51	16	0.041
	G1/4	7894 06 13	9	17	10	18.5	49	11	18	31	59.5	65	17	0.067
8	G1/8	7894 08 10	6	13	8	14	46	7	27	31	48.5	51	22	0.051
	G1/4	7894 08 13	9	17	10	18.5	49	11	23	31	59.5	65	23	0.068
10	G3/8	7894 08 17	7	20	14	22.5	69	13	21	40	67.5	73	23	0.060
	G3/8	7894 10 17	7	20	14	22.5	69	13	29	40	67.5	73	26	0.061
12	G1/2	7894 10 21	9	24	17	28	76	12.5	26	47	74	81	26	0.234
	G1/2	7894 12 21	9	24	17	28	76	12.5	27	47	74	81	30	0.237

Metal Quick Exhaust Valves

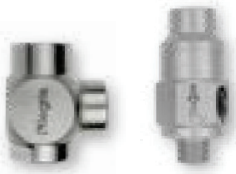

This range of metal quick exhaust valves is offered in nickel-plated brass, aluminium and stainless steel. The exhaust into the atmosphere accelerates the return speed of the cylinder rod.

Technical Characteristics

- **Compatible Fluids:** Compressed air
- **Working Pressure:** 7970: 0.7 to 10 bar
7971 and 7899: 2 to 10 bar
- **Working Temperature:** 7970: -20°C to +70°C
7971: -10°C to +70°C
7899: Threads G1/8 and G1/4: -10°C to +120°C
Threads G3/8 to G1: -20°C to +180°C

Advantages

- Cycle time reduction: increased return speed
- Exhaust silencer integrated and 360° orientation available on some versions

Operation

Mounted on Cylinder

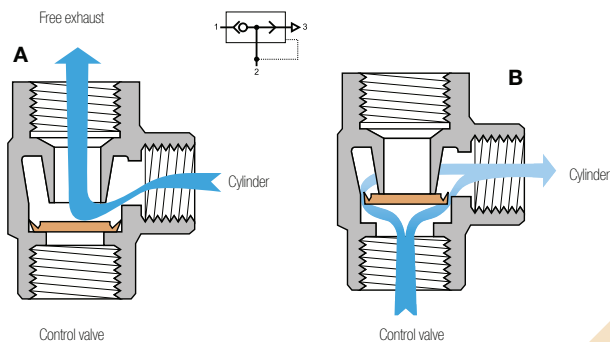

Component Materials

Silicone-free

Lip seals:
7970-7971: polyurethane elastomer
7899: - G1/8 and G1/4 FKM
- G3/8 to G1, polyurethane

Body:
Model 7970: nickel-plated brass
Model 7971: anodised aluminium
Model 7899: stainless steel

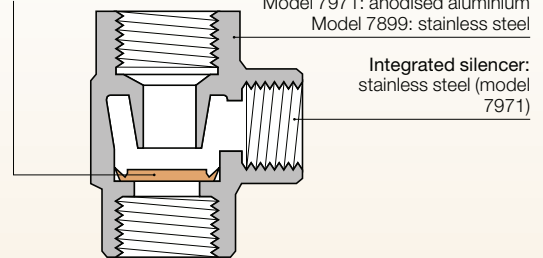

Integrated silencer:
stainless steel (model 7971)

Regulations

- RoHS
- REACH
- PED

Installation Diagram

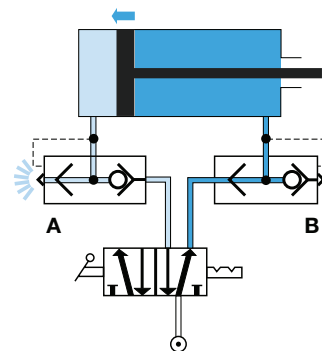

7970 Elbow Quick Exhaust Valve, Female BSPP and Metric Thread

Nickel-plated brass

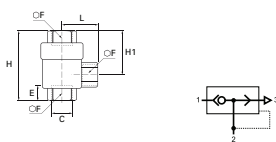

C		E	F	H	H1	L	Kg
M5x0.8	7970 19 19	5	10	24.8	15.6	4	0.029
G1/8	7970 10 10	7.5	14	42	28	8	0.084
G1/4	7970 13 13	11	19	53	34.5	11	0.150
G3/8	7970 17 17	12	21	58	36	12	0.153
G1/2	7970 21 21	14	26	71	44	14	0.312
G3/4	7970 27 27	16	32	86	52	18	0.449
G1	7970 34 34	19	38	94	56	19	0.528

7971 Elbow Quick Exhaust Valve, Male BSPT/ Female BSPP Thread

Treated aluminium

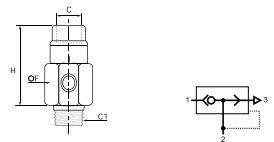

C	C1		F	H	Kg
G1/8	R1/8	7971 10 10	18	51	0.013
G1/4	R1/4	7971 13 13	18	49	0.018
G3/8	R3/8	7971 17 17	27	56	0.048
G1/2	R1/2	7971 21 21	34	70	0.086

Noise level:
7971 10 10: 70 dBa
7971 13 13: 70 dBa
7971 17 17: 72 dBa
7971 21 21: 88 dBa

Metal Quick Exhaust Valves

7899 Quick Exhaust Valve, Female BSP Thread

Stainless steel 316L

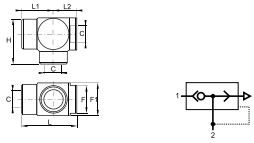

DN	C		F	F1	H	L	L1	L2	Kg
7	G1/8	7899 00 10	17	22	31.5	37.5	21	16.5	0.096
	G1/4	7899 00 13	17	22	31.5	37.5	21	16.5	0.083
9	G3/8	7899 00 17	22	26	37	44.5	25.5	19	0.140
12	G1/2	7899 00 21	27	32	45	54	31	23	0.235
18	G3/4	7899 00 27	38	46	65	79	44	35	0.800
	G1	7899 00 34	38	46	65	79	44	35	0.667

Noise level:

7971 10 10: 70 dBa

7971 13 13: 70 dBa

7971 17 17: 72 dBa

7971 21 21: 88 dBa

Non-Return Valves



Non-return valves allow compressed air to flow in one direction and prevent it from flowing in the other. Protect the circuit upstream.

Ø metric:
4 to 12 mm

Technical Characteristics

Compatible Fluids	Compressed air	
Working Pressure	1 to 10 bar	
Working Temperature	0°C to +70°C	
Cracking Pressure	0.3 bar	
Flow Characteristics (NI/min)	Model	Flow at 6 bar
	4 mm	350
	6 mm	670
	8 mm	1080
	10 mm	2230
12 mm	2300	

Component Materials

Silicone-free

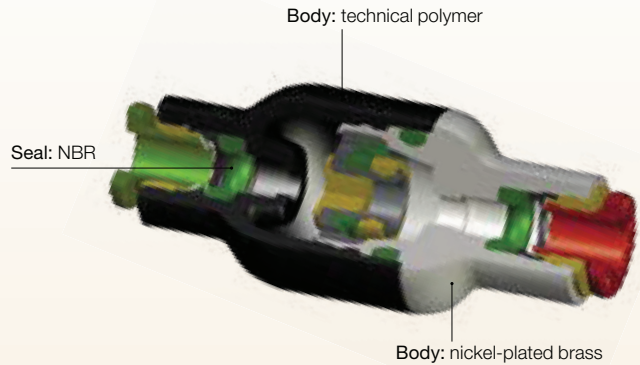

Advantages

- Available in threaded or push-in version
- Proven endurance according to the requirements of the DI 2006/42/CE

Safe installation:

- Symbol showing the operating direction of flow
- Colour code: green for supply version, red for exhaust version

Regulations

- RoHS
- REACH
- PED
- B10d: > 40 millions of cycles

Operation

In-Line Version

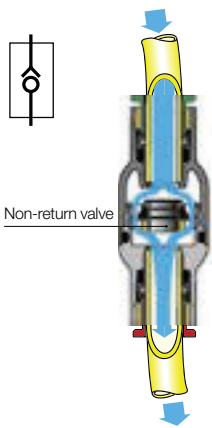

Supply Version

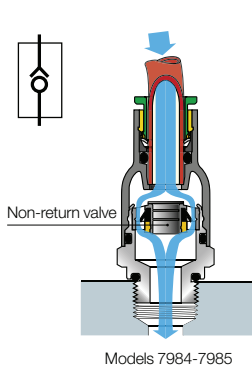

Exhaust Version

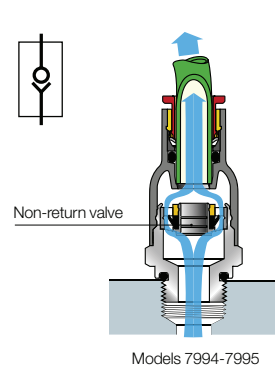

Installation Diagram

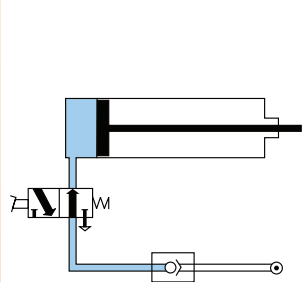

Non-Return Valves

7996 In-Line Equal Non-Return Valve

Technical polymer, Nickel-plated brass, NBR

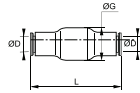

ØD		G	L	Kg
4	7996 04 00	16	38.5	0.008
6	7996 06 00	16	41	0.013
8	7996 08 00	19	51.5	0.017
10	7996 10 00	23	63.5	0.070
12	7996 12 00	23	66.5	0.050

7985 In-Line Non-Return Valve, Supply, Male BSPT Thread

Technical polymer, Nickel-plated brass, NBR

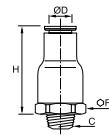

ØD	C		F	H	Kg
4	R1/8	7985 04 10	16	28.5	0.016
6	R1/8	7985 06 10	16	30.5	0.016
	R1/4	7985 06 13	16	30.5	0.021
8	R1/8	7985 08 10	19	36	0.022
	R1/4	7985 08 13	19	36	0.020
12	R1/2	7985 12 21	23	44	0.048

Pre-coated thread

7984 In-Line Non-Return Valve, Supply, Male BSPP and Metric Thread

Technical polymer, Nickel-plated brass, NBR

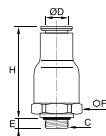

ØD	C		E	F	H	Kg
4	M5x0.8	7984 04 19	3	9	32	0.008
	G1/8	7984 04 10	5	16	28.5	0.015
6	G1/8	7984 06 10	5	16	30.5	0.015
	G1/4	7984 06 13	5.5	16	30.5	0.015
8	G1/8	7984 08 10	5	19	36	0.021
	G1/4	7984 08 13	5.5	19	36	0.023

7995 In-Line Non-Return Valve, Exhaust, Male BSPT Thread

Technical polymer, Nickel-plated brass, NBR

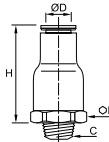

ØD	C		F	H	Kg
4	R1/8	7995 04 10	16	28.5	0.015
6	R1/8	7995 06 10	16	30.5	0.016
	R1/4	7995 06 13	16	30.5	0.022
8	R1/8	7995 08 10	19	36	0.022
	R1/4	7995 08 13	19	36	0.026
12	R3/8	7995 12 17	23	42	0.042

Pre-coated thread

7994 In-Line Non-Return Valve, Exhaust, Male BSPP and Metric Thread

Technical polymer, Nickel-plated brass, NBR

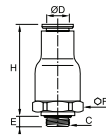

ØD	C		E	F	H	Kg
4	M5x0.8	7994 04 19	3	9	32	0.790
	G1/8	7994 04 10	5	16	28.5	0.018
6	G1/8	7994 06 10	5	16	30.5	0.015
	G1/4	7994 06 13	5.5	16	30.5	0.015
8	G1/8	7994 08 10	5	19	36	0.023
	G1/4	7994 08 13	5.5	19	36	0.023
12	G1/2	7994 12 21	7.5	23	44	0.045

Adjustable Non-Return Valves

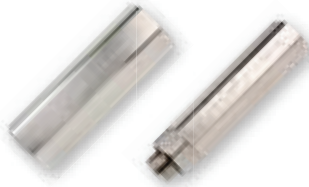

These nickel-plated brass adjustable non-return valves allow compressed air to flow in one direction and prevent flow in the other. They incorporate precise adjustment of opening pressure in the return direction.

Technical Characteristics

- **Compatible Fluids:** compressed air
- **Working Pressure:** 0 to 12 bar
- **Working Temperature:** -20°C to +80°C

Cracking Pressure	Threads		0 to 4 turns (values given as an example only)	
		M5x0.8 - G1/8 - G1/4		1
	G3/8		1	0.15 bar
	G1/2		1	0.20 bar

Max. Tightening Torques	Threads	M5 x0.8	G1/8	G1/4	G3/8	G1/2
		daN.m	0.16	0.8	1.2	3

Advantages

- Adjustment and locking of the non-return valve cracking pressure with two 2 Allen keys prevents the settings from being accidentally changed
- Designed with locking nut to protect initial setting in the event of vibration or accidental handling
- Developed for the food process industry (FDA compliance) and smooth external profile to facilitate cleaning in situ

Operation

Step 1

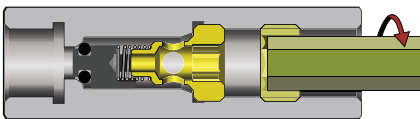

Unscrew the locking nut with an Allen key.

Step 2

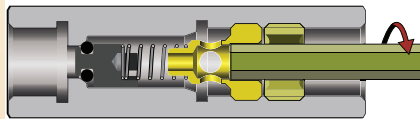

Unscrew the adjustment nut with a smaller Allen key to adjust the cracking pressure. The number of turns adjusts the cracking pressure from 1 bar to 0.10 bar.

Step 3

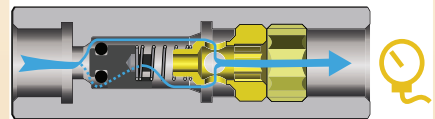

Tighten the locking nut with the Allen key to lock the cracking pressure setting. Then, control the pressure with a pressure gauge downstream.

Component Materials

External Components

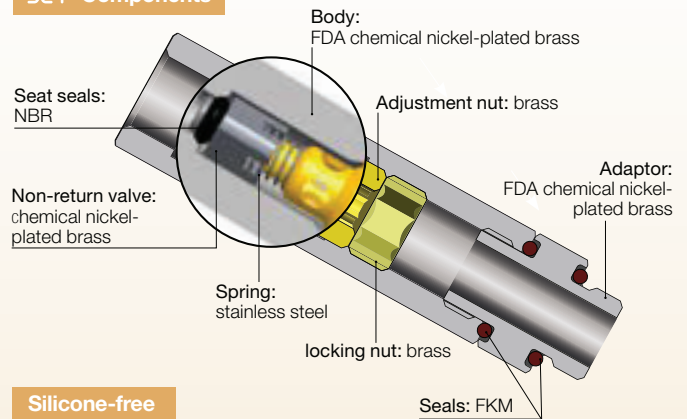

Silicone-free

Regulations

- RoHS
- REACH
- FDA : 21CFR

7930 Adjustable Check Valve, Double Female BSPP and Metric Thread

FDA chemical Nickel-plated brass, FKM

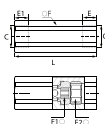

C	E	E1	F	F1	F2	L	Kg
M5x0.8 7930 19 19	8	4	13	4	6	49	0.055
G1/8 7930 10 10	8	6	13	4	6	45	0.033
G1/4 7930 13 13	10	7.5	16	6	8	54	0.073
G3/8 7930 17 17	11	8.5	20	8	10	61.5	0.163
G1/2 7930 21 21	13	10	24	10	12	73	0.171

7931 Adjustable Check Valve Supply, Male/Female BSPP Thread

FDA chemical Nickel-plated brass, FKM

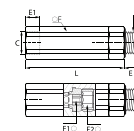

C	E	E1	F	F1	F2	L	Kg
G1/8 7931 10 10	5.5	6	13	4	6	51.5	0.043
G1/4 7931 13 13	6.5	7.5	16	6	8	61.5	0.208
G3/8 7931 17 17	7.5	8.5	20	8	10	70	0.125
G1/2 7931 21 21	9	10	24	10	12	82.5	0.212

Adjustable Non-Return Valves

7932 Adjustable Check Valve Exhaust, Male/ Female BSPP Thread

FDA chemical Nickel-plated brass, FKM

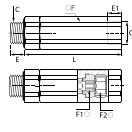

C		E	E1	F	F1	F2	L	Kg
G1/8	7932 10 10	5.5	8	13	4	6	51.5	0.009
G1/4	7932 13 13	6.5	10	16	6	8	61.5	0.058
G3/8	7932 17 17	7.5	11	20	8	10	70	0.123
G1/2	7932 21 21	9	13	24	10	12	82.5	0.212

Complementary Products for Adjustable Non-Return Valves

Fittings

LF 3000



LF 3600



Nickel-Plated Accessories





LIQUIfit® non-return valves allow flow in one direction and prevent any return flow. Fitted in the circuit, they provide total protection.

Ø metric: 6 to 12 mm
Ø inch: 1/4" to 1/2"

Technical Characteristics

- **Compatible Fluids:** water, beverages, liquid foodstuffs
- **Working Pressure:** 1 to 10 bar
- **Working Temperature:** 1°C to +65°C
- **Cracking Pressure:** 0.02 bar up to O.D. 3/8"
0.03 bar for O.D. 1/2"

Advantages

- Fully compatible for use with water, beverages, liquid foodstuffs and gas
- Excellent chemical compatibility
- Hygienic design with smooth surfaces

Component Materials

Silicone-free



Regulations

- RoHS
- FDA: 21 CFR
- NSF 51
- REACH

7992 Single Non-Return Valve

POM, EPDM

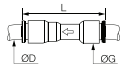

ØD		G	L	Kg
6	7992 06 00WP2	15.5	45.5	0.007
8	7992 08 00WP2	17.5	48.5	0.010
10	7992 10 00WP2	20	57.5	0.014
12	7992 12 00WP2	23.5	67.5	0.022

7992 Single Non-Return Valve

Inch

POM, EPDM



ØD		G	L	Kg
1/4	7992 56 00WP2	17	51	0.008
3/8	7992 60 00WP2	20	55	0.011
1/2	7992 62 00WP2	23	68	0.021

5/16" also available = 7992 08 00WP2

Associated Products

The full range of LIQUIfit® products can be found in this catalogue:

- Push-in fittings for metric and inch tubing (Chapter 1)
- Valves (Chapter 4)

To complement the LIQUIfit® range, Parker Legris Advanced PE tubing (Chapter 3) is suited to the most demanding environments, approved for permanent contact with beverage and food products, as well as for water treatment.

Stainless Steel Non-Return Valves

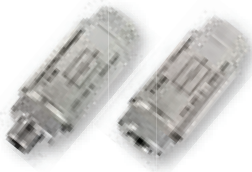

In harsh environments or for corrosive industrial fluids, stainless steel non-return valves allow fluids to flow in one direction and prevent them from flowing in the other.

Technical Characteristics

- **Compatible Fluids:** Many fluids
- **Working Pressure:** 0.5 to 40 bar
- **Working Temperature:** -20°C to +180°C

	Threads	NI/min	Kv
Flow Characteristics	G1/8	18.88	1.60
	G1/4	19.91	1.69
	G3/8	35.54	3.01
	G1/2	36.50	3.10
	G3/4	65.86	5.59
	G1	92.60	7.86
Cracking Pressure	0.25 bar		

Advantages

- Mechanical robustness and reduced dimensions
- Suitable for use with many chemicals or in corrosive environments
- Flow direction symbol protects against incorrect installation
- Smooth external surfaces contribute to equipment cleanliness

Component Materials

Silicone-free

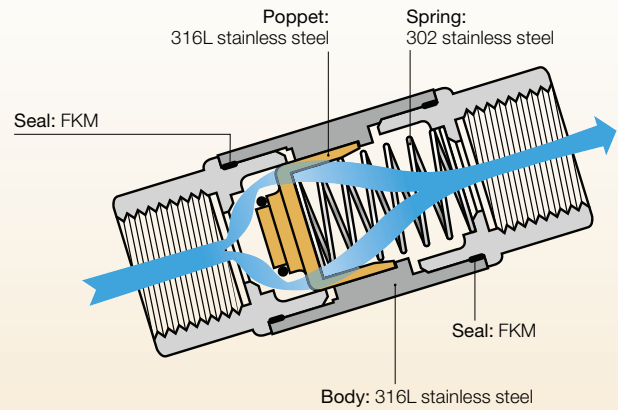

Regulations

- RoHS
- REACH
- PED

4890 Non-Return Valve, Female BSPP Thread

Stainless steel 316L, FKM

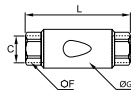

DN	C		F	G	L	Kg
10	G1/8	4890 10 10	17	22	50	0.082
	G1/4	4890 13 13	17	22	50	0.073
15	G3/8	4890 17 17	22	30	67	0.183
	G1/2	4890 21 21	24	30	71	0.182
20	G3/4	4890 27 27	32	42	84	0.288
25	G1	4890 34 34	38	42	90	0.418

4892 Non-Return Valve, Supply, Female BSPP Thread/Exhaust, Male BSPP Thread

Stainless steel 316L, FKM

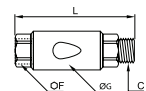

DN	C		F	G	L	Kg
10	G1/8	4892 10 10	17	22	56	0.090
	G1/4	4892 13 13	17	22	58	0.082
15	G3/8	4892 17 17	22	30	75	0.191
	G1/2	4892 21 21	24	30	79	0.210
20	G3/4	4892 27 27	32	42	84	0.313
25	G1	4892 34 34	38	42	102	0.514

4891 Non-Return Valve, Supply, Male BSPP Thread/Exhaust, Female BSPP Thread

Stainless steel 316L, FKM

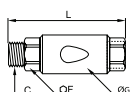

DN	C		F	G	L	Kg
10	G1/8	4891 10 10	17	22	56	0.084
	G1/4	4891 13 13	17	22	58	0.082
15	G3/8	4891 17 17	22	30	75	0.191
	G1/2	4891 21 21	24	30	79	0.210
20	G3/4	4891 27 27	32	42	84	0.300
25	G1	4891 34 34	38	42	102	0.519

4895 Non-Return Valve, Female NPT Thread

Stainless steel 316L, FKM

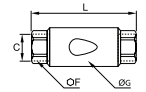

DN	C		F	G	L	Kg
10	NPT1/8	4895 11 11	17	22	50	0.082
	NPT1/4	4895 14 14	17	22	54	0.079
15	NPT3/8	4895 18 18	22	30	67	0.194
	NPT1/2	4895 22 22	24	30	77	0.195

Soft Start Fittings



To prevent the risk of industrial accidents, the pressure increase in the downstream circuit allows soft start of the installation.

Ø metric:
8 to 10 mm

Technical Characteristics

- **Compatible Fluids:** Compressed air
- **Working Pressure:** 3 to 10 bar
- **Working Temperature:** -15°C to +60°C

Max. Tightening Torques	Threads		daN.m
	G1/4		1.3
	G3/8		1.5
G1/2		1.8	

Flow Characteristics	Model	Flow at 6 bar	Kv
	7860 08 13	1500 NI/min	0.80
	7860 10 13	2100 NI/min	1.20
	7860 10 17	2200 NI/min	1.30
	7870 08 13	1500 NI/min	0.80
	7870 10 13	2000 NI/min	1.15
7870 10 17	2000 NI/min	1.15	

Component Materials

Silicone-free



Operation

Filter, Regulator, Lubricator

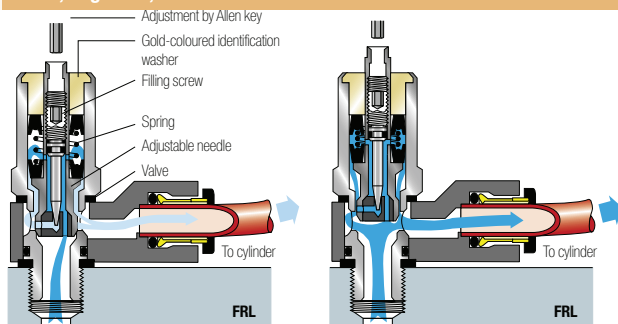

Control Valve

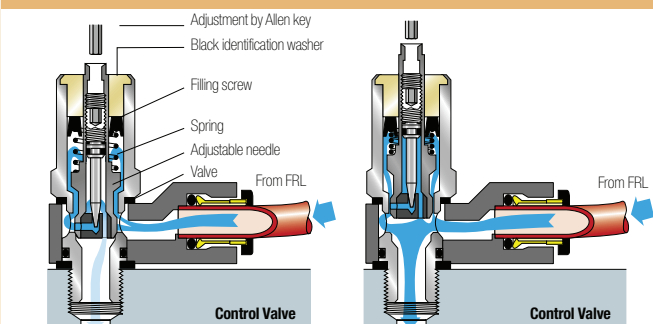

Adjustment of the Filling Screw

Adjusting the screw to regulate the flow of air optimises the time taken to pressurise depending on the air volume to be refilled and the system requirements.

To adjust:

- immobilise the piston using a spanner
- adjust the screw with an Allen key
 - 1.5 mm key for 8 mm diameter
 - 2.5 mm key for 10 and 12 mm diameter

Max. tightening torque: 0.1 daN.m

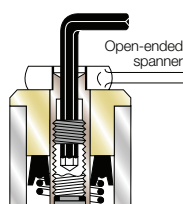

Advantages

Protection of equipment and personnel:

- Prevents the risk of damage after any stoppage which requires the system to be vented
- Returns the control valve to its initial position in total safety
- Adjustment of the pressurisation speed

Mounted on FRL:

- 7860: yellow identification washer
- Protection for the whole system
- Simultaneous pressurisation speed of the whole system

Mounted on Control Valve:

- 7870: black identification washer
- Protection of individual circuits
- Mounted on the control valve, it optimises the pressurisation speed of a specific cylinder

Regulations

- RoHS
- REACH
- PED

Cylinder Pressure Cycle

When the downstream pressure reaches 2/3 of the supply pressure, full flow is automatically established

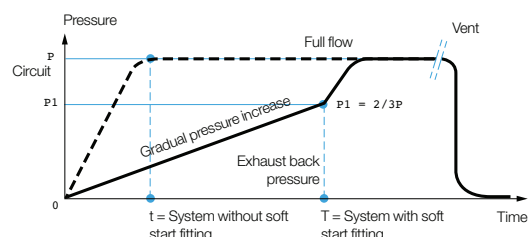

Soft Start Fittings

7860 Soft Start Fitting for Isolating Valve, Male BSPP Thread

Technical polymer, Nickel-plated brass, NBR

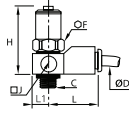

ØD	C		F	H max	H min	J	L	L1	Kg
8	G1/4	7860 08 13	17	61	54	20	35	10	0.064
10	G1/4	7860 10 13	22	62	55	25	41	12.5	0.112
	G3/8	7860 10 17	22	62	55	25	41	12.5	0.115

7870 Soft Start Fitting for Control Valve, Male BSPP Thread

Technical polymer, Nickel-plated brass, NBR

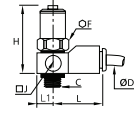

ØD	C		F	H max	H min	J	L	L1	Kg
8	G1/4	7870 08 13	17	61	54	20	35	10	0.066
10	G1/4	7870 10 13	22	62	55	25	41	12.5	0.113
	G3/8	7870 10 17	22	62	55	25	41	12.5	0.116

Our Safety Programm: Conformity to 2006/42/EC Directive and ISO 13849-1 Standard

More than 250 dedicated part numbers for:

- Zero accident for our customers
- Machine integrity
- Compliance of equipment

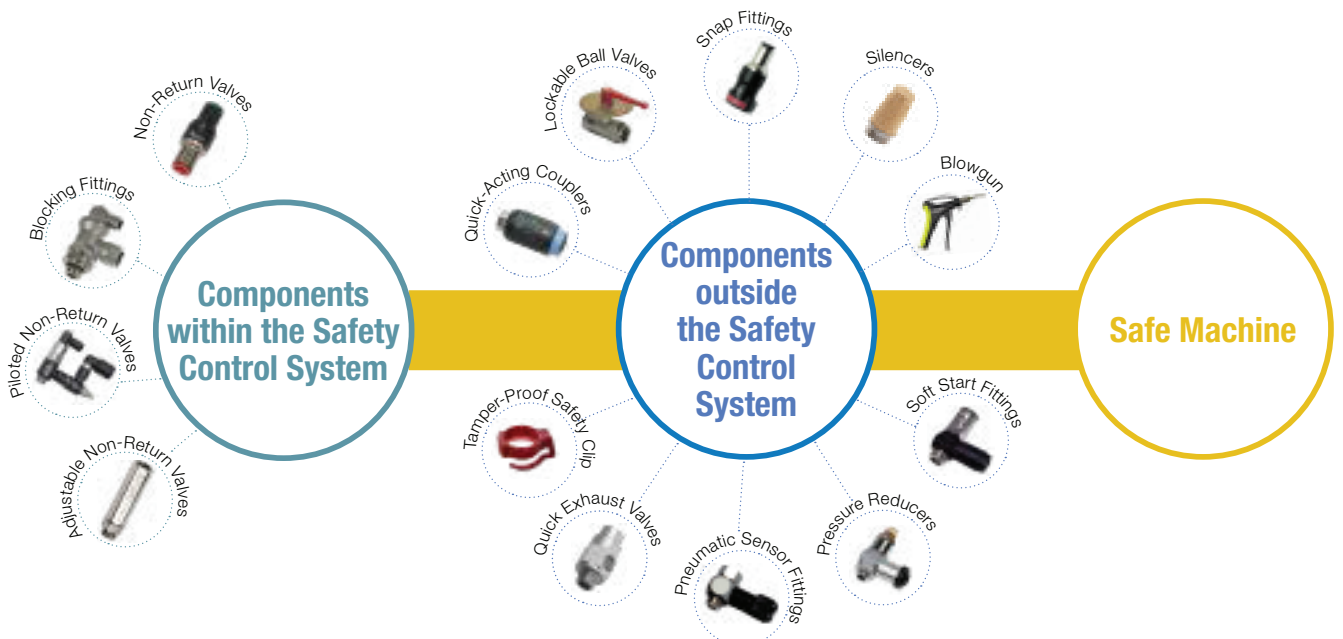

Pressure Regulator Fittings



Pressure regulators stabilise at the maximum determined value the pressure, whatever the fluctuations of the pressure upstream.

Ø metric:
4 to 10 mm

Technical Characteristics (7300)

- **Compatible Fluids:** Compressed air
- **Working Pressure:** Upstream pressure: 1 to 16 bar
Downstream pressure: 1 to 8 bar
- **Working Temperature:** -10°C to +70°C

Tightening Torque (BSPT)	Thread	G1/8	G1/4	G3/8
	daN.m		0.4	0.5

Advantages

- Lockable adjustment possible of the setpoint
- Output pressure adjustment options marked on the screw
- Installation in a manifold allows optimum output pressures to be delivered to specific parts of the circuit
- Designed for applications where cylinder force needs to be controlled: marking, sleeving, crimping cylinders etc.

Component Materials (7300)

Silicone-free

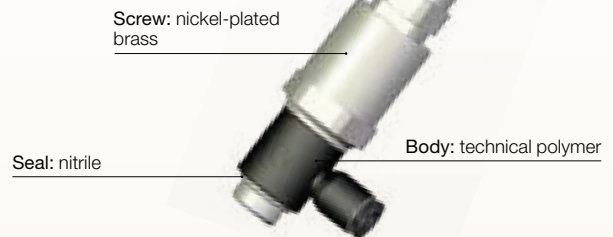

Regulations

- RoHS
- REACH
- PED

Operation

Mounting Upstream of the Control Valve

Adjustment of the piston feed pressure in both directions

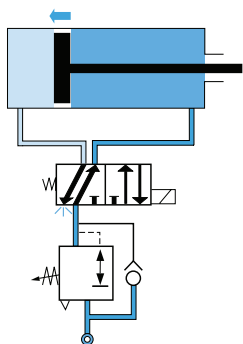

Mounting Downstream of the Control Valve

Phase 1: adjustment of the piston speed in a single direction

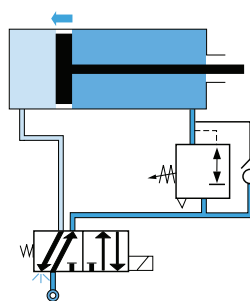

Phase 2: in return direction, pressure is supplied through the control valve

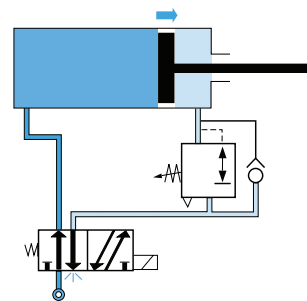

Flow Characteristics at 7 bar (Nl/min)

G1/8 Models

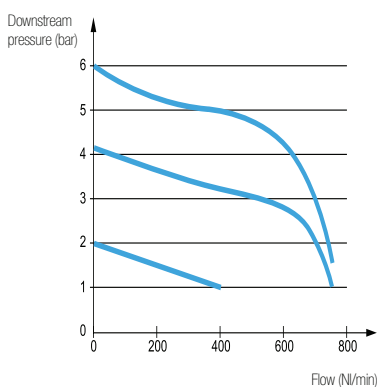

G1/4 Models

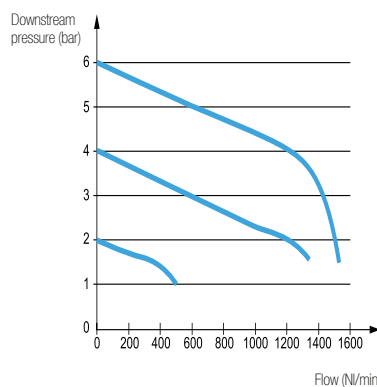

G3/8 Models

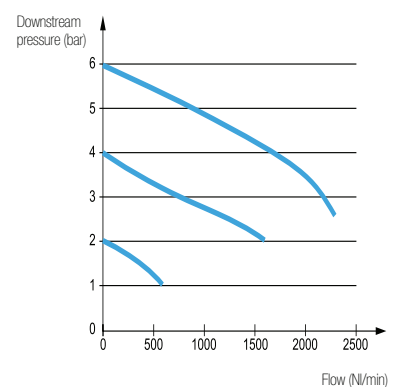

Pressure Regulator Fittings

7300 Pressure Regulator, Male BSPP Thread

Technical polymer, Nickel-plated brass, NBR

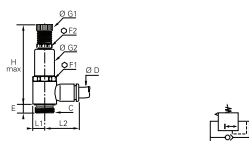

ØD	C		E	F1	F2	G1	G2	H max	L1	L2	Kg	
4	G1/8		7300 04 10	4.5	17	13	14	17	65	7	18.5	0.047
	G1/8		7300 06 10	4.5	17	13	14	17	65	7	20	0.047
6	G1/4		7300 06 13	7.5	17	13	14	17	74.5	9.5	22	0.065
	G1/8		7300 08 10	4.5	17	13	14	17	65	7	25	0.048
8	G1/4		7300 08 13	7.5	17	13	14	17	74.5	9.5	27	0.066
	G3/8		7300 08 17	8.5	22	17	18.5	22	84	11.5	28.5	0.122
10	G1/4		7300 10 13	7.5	17	13	14	17	74.5	9.5	29	0.066
	G3/8		7300 10 17	8.5	22	17	18.5	22	84	11.5	30.5	0.122

DRV Pressure Reducing Valve

Brass



A	A1		HEX	L	L1	Const. Supply Pressure	max. Supply Pressure	
G1/4	G1/4		DRV13/20	17	34	9	2 bar	15 bar
G1/4	G1/4		DRV13/30	17	34	9	3 bar	15 bar
G1/4	G1/4		DRV13/40	17	34	9	4 bar	15 bar
G1/4	G1/4		DRV13/50	17	34	9	5 bar	15 bar
G1/4	G1/4		DRV13/60	17	34	9	6 bar	15 bar
G1/4	G1/4		DRV13/70	17	34	9	7 bar	15 bar
G1/4	G1/4		DRV13/80	17	34	9	8 bar	15 bar
G1/4	G1/4		DRV13/100	17	34	9	10 bar	15 bar

Pneumatic Sensor Fittings

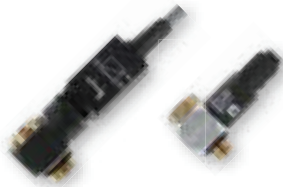

The sensor produce a pneumatic or electric output signal when the pressure drop in the exhaust chamber of the cylinder goes below their back pressure threshold.

Ø metric:
4 mm

Technical Characteristics

- **Compatible Fluids:** Compressed air
- **Working Pressure:** 3 to 8 bar
- **Working Temperature:** -15°C to +60°C
- **Back Pressure:** 0.85 to 1 bar
- **Switching Time:** Model 7818: 3 ms
- **Open/Closed Contact:** Model 7828: 2A / 0-48 V
2A / 250 V 50 Hz

Advantages

- Detection of end of cylinder rod stroke
- With Pneumatic Output**
Totally pneumatic installation
2 possible installations:
- Supplied with permanent pressure (P1): produces a pneumatic signal when the back pressure threshold is reached
 - Supplied from the control valve-cylinder circuit on the opposite side: no unexpected pneumatic signal (S) can appear during pressurisation due to the actuating pressure which supplies the sensor fitting (P1)
- With Electrical Output**
- Combined electrical and pneumatic installation
 - Installation with continuous electrical supply only (BU)
 - Guarantees an electrical signal when the back pressure threshold is reached

Component Materials

Silicone-free

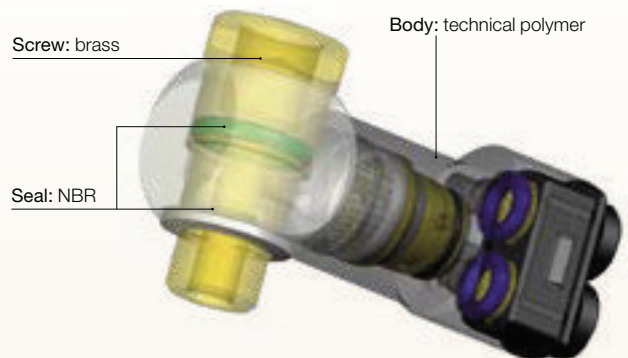

Regulations

- RoHS
- REACH
- PED

Operation

Pneumatic Installation Diagram



P': Exhaust back pressure
P: Dynamic pressure
P1: Sensor supply pressure
S: Output signal

Electrical Installation Diagram

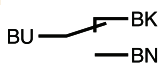

Connection via 3 core 0.5 mm² cable, 2 meters long.
Contactor: 5A / 250 V ~ or 5W / 48V ==

Cylinder in Operation

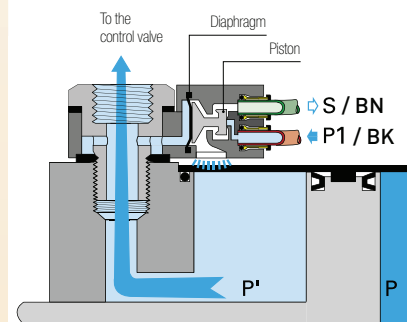

Cylinder in Final Position

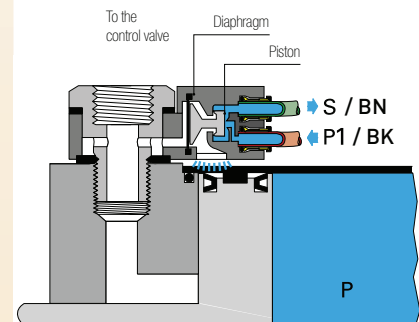

Cylinder Pressure Cycle

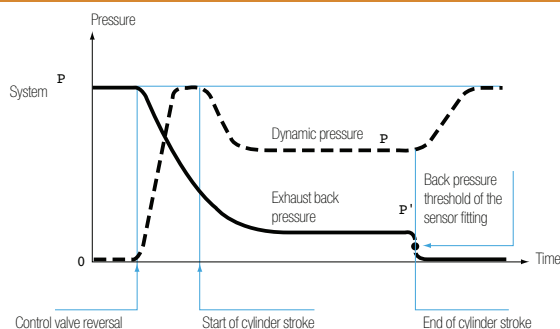

Installation Diagram

Depending on model, S1, S2 and P1 may be pneumatic or electric. See the installation diagrams opposite.

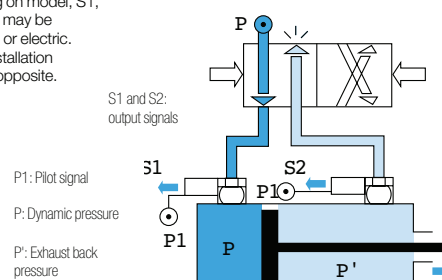

Pneumatic Sensor Fittings

7818 Pneumatic Sensor Fitting, Male BSPP and Metric Thread

Zamak, NBR, technical polymer, brass

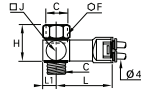

ØD	C		F	H	J	L	L1	Kg
M5x0.8	7818 04 19*		8	16	11	43.5	5.5	0.025
G1/8	7818 04 10		14	23	16	44.5	8	0.043
4	G1/4	7818 04 13	17	28	19.5	46.5	10	0.061
	G3/8	7818 04 17	22	29	23.5	49	12	0.083
	G1/2	7818 04 21	27	30	31.5	52.5	16	0.125

* Bolt zinc passivated steel

7828 Pneumatic/Electric Sensor, Male/Female BSPP and Metric Thread

Technical polymer, NBR, brass

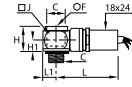

C		F	H	H1	J	L	L1	Kg
M5x0.8	7828 00 19	8	20	10	11	49	5.5	0.116
G1/8	7828 00 10	6	20	10	16	52	8	0.132
G1/4	7828 00 13	8	20	10	21	54	10.5	0.142
G3/8	7828 00 17	10	22	12	28	57	14	0.171

7818 Pneumatic Sensor, Male/Female BSPP Thread

Zamak, NBR, technical polymer, brass

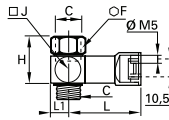

C		F	H	J	L	L1	Kg
G1/8	7818 19 10	14	23	16	40.5	8	0.049
G1/4	7818 19 13	17	28	19.5	42.5	10	0.065

Snap Fittings



The snap fittings enable a circuit to be isolated without the need to vent the complete system.

Ø metric:
6 to 10 mm

Technical Characteristics

- **Compatible Fluids:** Compressed air
- **Working Pressure:** 0 to 10 bar
- **Working Temperature:** -20°C to +80°C
- **Flow Characteristics at 6 bar:** DN 5 mm: 1000 NI/min
DN 7 mm: 1900 NI/min

Tightening Torque (BSPT)	Thread	G1/8	G1/4	G3/8
	daN.m	0.8	1.2	3

Advantages

- Partial venting of systems for energy and time-saving during maintenance operations
- Protection of individuals by maintaining pressure if necessary
- Audible click indicates connection
- Circuit identification by coloured rings (on request)

Component Materials

Silicone-free

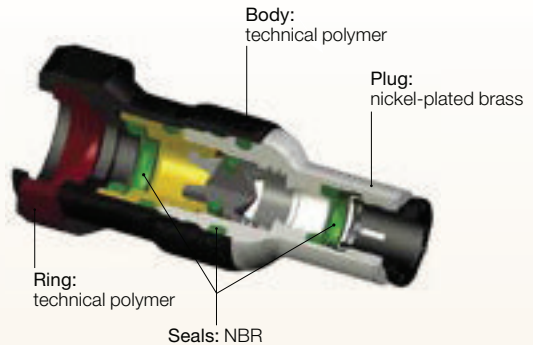

Regulations

- RoHS
- REACH
- PED

Operation

Circuit Closed

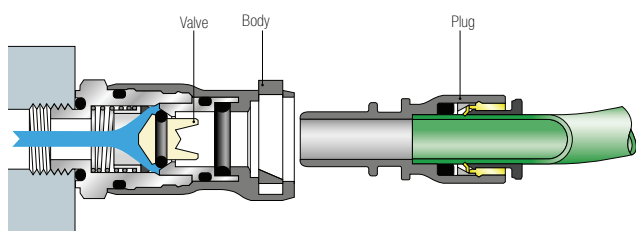

Circuit Open

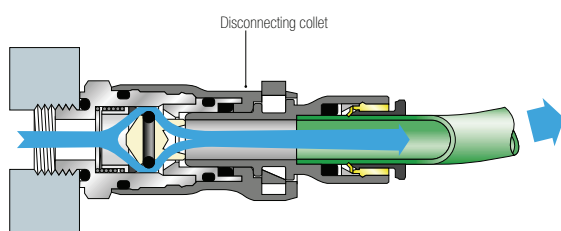

Flow Characteristics - Pressure Drop

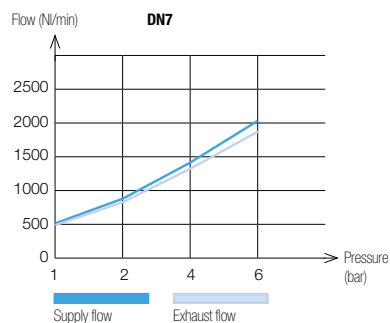
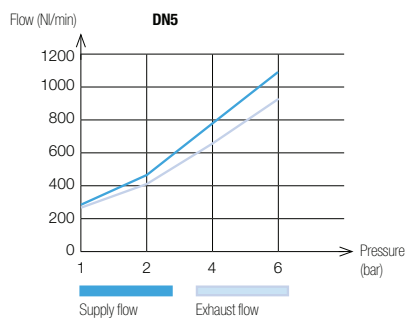

7926 Body with Push-In Connection

Technical polymer, Nickel-plated brass, NBR

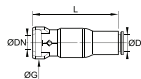

DN	ØD		G	L	Kg
5	6	7926 05 06	18.5	44	0.020
5	8	7926 05 08	18.5	49	0.024
7.3	10	7926 07 10	22	58.5	0.044

7960 Straight Probe, Push-In Connection

Technical polymer, NBR

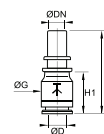

DN	ØD		G	H	H1	Kg
5	6	7960 05 06	13.5	36.5	17.5	0.007
5	8	7960 05 08	13.5	37	18	0.003
7.3	10	7960 07 10	16	41	20.5	0.004

7921 Body with Male BSPP Thread

Technical polymer, Nickel-plated brass, NBR

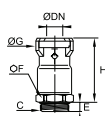

DN	C		E	F	G	H	Kg
5	G1/8	7921 05 10	5.5	16	18.5	31.5	0.021
5	G1/4	7921 05 13	5.5	16	18.5	31.5	0.023
7.3	G1/4	7921 07 13	5.5	20	22	37.5	0.039
7.3	G3/8	7921 07 17	5.5	20	22	37.5	0.040

7961 Straight Probe, Male BSPP Thread

Technical polymer, Nickel-plated brass, NBR

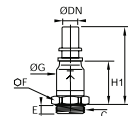

DN	C		E	F	G	H	H1	Kg
5	G1/8	7961 05 10	5.5	13	13.5	46	27	0.017
5	G1/4	7961 05 13	5.5	16	13.5	46	27	0.020
7.3	G1/4	7961 07 13	5.5	16	16	51.5	31	0.025
7.3	G3/8	7961 07 17	5.5	20	16	51.5	31	0.034

Manually-Operated Valves

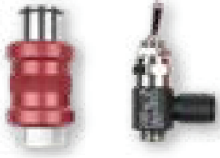

Manually-operated provide a significant reduction in the time needed to work on pneumatic circuits and isolate the circuit when the system has to be switched frequently.

Ø metric:
4 to 8 mm

Technical Characteristics

- **Compatible Fluids:** Compressed air
- **Working Pressure:** 0 to 10 bar
Model 0669: 0 to 16 bar
- **Working Temperature:** -10°C to +80°C
Model 0669: -5°C to +70°C

Advantages

Manual switch-operated valves:

- 2 models:
 - 3/2: opening, closing, venting
 - 2/2: opening, closing
- Can be positioned through 360°

Manual switch-operated valves:

- Uni-directional use ensures the downstream circuit is vented
- Identification of the venting system by the colour (red)

Component Materials

Silicone-free

Seals: NBR

Bolt:
Manual switch-operated valve: nickel-plated brass with seal
Sleeve valve: nickel-plated brass

Lever:
nickel-plated brass

locking nut:
nickel-plated brass

Body:

Manual switch-operated valve: technical polymer
Sleeve valve: nickel-plated brass

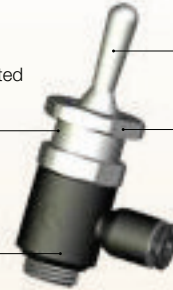

Regulations

• RoHS

• REACH

• PED

Operation

Switch-Operated Valves

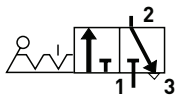

Open

Closed

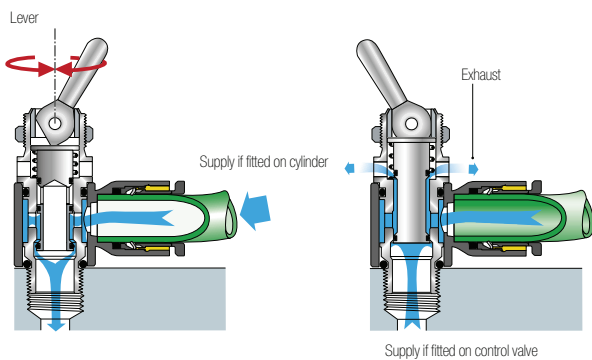

Sleeve Valves

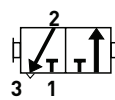

Open: downstream supply

Closed: downstream exhaust

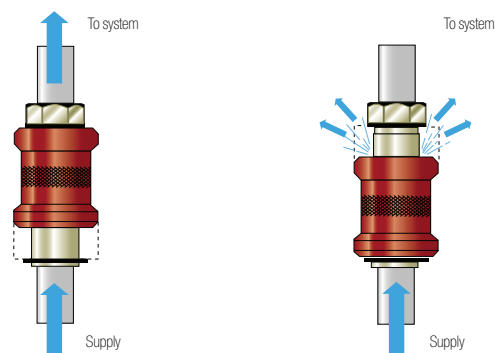

Manually-Operated Valves

7800 3/2 Manual Switch-Operated Valve, Supply, Male BSPP and Metric Thread

Technical polymer, Nickel-plated brass, NBR

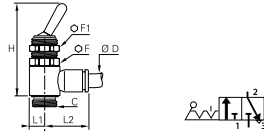

ØD	C		F	F1	H	L1	L2	Kg
4	M5x0.8	7800 04 19	14	14	55	7	18.5	0.032
	G1/8	7800 04 10	14	14	43	7	18.5	0.023
6	M5x0.8	7800 06 19	14	14	55	7	18.5	0.032
	G1/8	7800 06 10	14	14	43	7	20	0.023
	G1/4	7800 06 13	17	14	50.5	9	22	0.048
8	G1/8	7800 08 10	14	14	43	7	25	0.024
	G1/4	7800 08 13	17	14	50.5	9	27	0.049

For part numbers 7800 04 19 and 7800 06 19, adaptor sealing is effected by a flat PTFE seal and tightening torque is maximum 0.16 daN.m.

7801 3/2 Manual Switch-Operated Valve, Control, Male BSPP Thread

Technical polymer, Nickel-plated brass, NBR

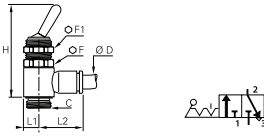

ØD	C		F	F1	H	L1	L2	Kg
4	G1/8	7801 04 10	14	14	43	7	18.5	0.023
	G1/8	7801 06 10	14	14	43	7	20	0.023
6	G1/4	7801 06 13	17	14	50.5	9	22	0.050
	G1/8	7801 08 10	14	14	43	7	25	0.026

7802 2/2 Manual Switch-Operated Valve, Male BSPP Thread

Technical polymer, Nickel-plated brass, NBR

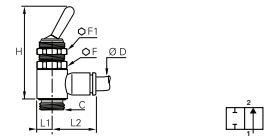

ØD	C		F	F1	H	L1	L2	Kg
4	G1/8	7802 04 10	14	14	43	7	18.5	0.023
	G1/8	7802 06 10	14	14	43	7	20	0.024
6	G1/4	7802 06 13	17	14	50.5	9	22	0.051
	G1/8	7802 08 10	14	14	43	7	25	0.025
8	G1/4	7802 08 13	17	14	50.5	9	27	0.052

0669 3/2 Sleeve Valve, Female BSPP and Metric Thread

Nickel-plated brass, NBR

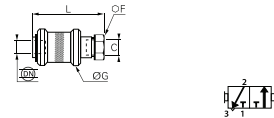

DN	C		F	G	L	Kg
2.5	M5x0.8	0669 02 19	10	14	30.5	0.012
4	G1/8	0669 04 10	14	25	48	0.050
7	G1/4	0669 07 13	19	30	58	0.096
10	G3/8	0669 10 17	22	35	68	0.154
14	G1/2	0669 14 21	27	40	75	0.210
19	G3/4	0669 19 27	32	50	83	0.330

Silencers



Silencers are designed for installation on exhaust circuits to reduce the noise levels of equipment while operating, thus improving user comfort.

Technical Characteristics

- **Compatible Fluids:** Compressed air
- **Working Pressure:** Polyethylene: 0 to 10 bar
Sintered bronze: 0 to 12 bar
316L stainless steel: 0 to 12 bar
- **Working Temperature:** Polyethylene: -10°C to +80°C
Sintered bronze: -20°C to +150°C
316L stainless steel: -20°C to +180°C

Advantages

- 3 materials available :
 - Polyethylene: optimum exhaust flow rate and noise attenuation
 - Sintered bronze: robust and economic
 - 316L stainless steel: increased chemical and mechanical resistance
- Incorporated flow control regulator on 2 versions

Component Materials

Silicone-free

Body:
brass (0670-0673-0675-0671-0677-0672)
polymer (0674-0676)
stainless steel (0682-0683)

Silencer:
sintered bronze (0670-0673-0675-
0671-0677-0672)
polymer (0674-0676)
316L stainless steel (0682-0683)



Regulations

- RoHS
- REACH
- PED
- 2003/10/CE
- OSHA

Flow and Noise Levels for Silencers 0672 and 0676

0672

	Number of Turns						Noise Level in dBA at 6 bar and 350 NI/min
	0	1	2	3	4	5	
0672 00 10	0	200	600	740	-	-	81
0672 00 13	0	300	650	1280	-	-	82
0672 00 17	0	450	950	1300	1500	-	83
0672 00 21	0	830	1430	1800	2100	2220	83

0676

	Number of Turns										Noise Level in dBA at 6 bar and 350 NI/min
	0	1	2	3	4	5	6	7	8	9	
0676 00 10	0	30	90	210	335	370	390	390	395	395	82
0676 00 13	0	22	25	50	340	750	940	980	1000	1025	84
0676 00 19	0	22	69	97	125	143	-	-	-	-	81
0676 00 17	0	518	1147	1716	2153	2571	2823	2930	-	-	85
0676 00 21		814	1849	2880	4087	5044	5236	-	-	-	86

0674 Polymer Silencer, Male BSPP and Metric Thread

Technical polymer

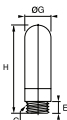

C		E	G	H	Kg
M5x0.8	0674 00 19	4	6.5	23	0.003
G1/8	0674 00 10	6	12.5	34	0.002
G1/4	0674 00 13	7	15.5	42.5	0.003
G3/8	0674 00 17	11.5	18.5	67.5	0.006
G1/2	0674 00 21	11	23.5	78	0.010
G3/4	0674 00 27	15.5	38.5	131	0.035
G1	0674 00 34	19.5	49	160	0.056

0676 Flow Control Polymer Silencer, Male BSPP and Metric Thread

Technical polymer

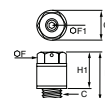

C		F	F1	G	H	H1	Kg
M5x0.8	0676 00 19	8	1.5	9.2	16	11	0.008
G1/8	0676 00 10	13	2.5	15	20.5	14.5	0.003
G1/4	0676 00 13	15	4	18	29	22	0.006
G3/8	0676 00 17	20	6	24	38	30	0.018
G1/2	0676 00 21	25	8	30	50	40	0.045

0670 Threaded Silencer, Male BSPP Thread

Sintered bronze, brass

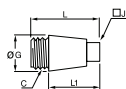

C		G	J	L	L1	Kg
G1/8	0670 00 10	12	7	22	17	0.007
G1/4	0670 00 13	15	9	27	21	0.015
G3/8	0670 00 17	19	11	35	28	0.027
G1/2	0670 00 21	23	13	43	34	0.042
G3/4	0670 00 27	30	17	55	53.5	0.089
G1	0670 00 34	37	21	65	53	0.145

0673 Compact Silencer, Male BSPP and Metric Thread

Brass

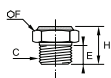

C		E	F	H	Kg
M5x0.8	0673 00 19	4	8	8.5	0.001
G1/8	0673 00 10	6	13	12	0.008
G1/4	0673 00 13	8	16	16	0.012
G3/8	0673 00 17	8	19	17	0.022
G1/2	0673 00 21	9	24	18	0.041

0675 Threaded Silencer, Male BSPP and Metric Thread

Brass



C		F	L	L1	Kg
M5x0.8	0675 00 19	8	17	13	0.002
M7x1	0675 00 55	10	23	20	0.006
G1/8	0675 00 10	13	26	20	0.014
G1/4	0675 00 13	16	34	26	0.014
G3/8	0675 00 17	19	41	33	0.024
G1/2	0675 00 21	24	46	36	0.073

0671 Push-In Silencer

Nickel-plated brass



ØD		G	L	L1	Kg
4	0671 04 00	13	43.5	28.5	0.014
6	0671 06 00	15	50	33.5	0.024
8	0671 08 00	15	51	34	0.025
10	0671 10 00	19.5	67	45.5	0.052
12	0671 12 00	20	68	45	0.052

0677 Miniature Silencer, Male BSPP Thread

Brass

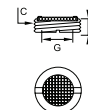

C		G	H	Kg
G1/8	0677 00 10	5.5	4	0.002
G1/4	0677 00 13	6	4.5	0.003
G3/8	0677 00 17	9.5	5	0.006
G1/2	0677 00 21	12.5	5.5	0.010
G3/4	0677 00 27	19	6	0.019
G1	0677 00 34	24	7	0.025

0672 Flow Control Silencer, Male BSPP Thread

Sintered bronze, brass

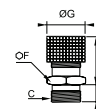

C		E	F	G	H max	H min	Kg
G1/8	0672 00 10	8	14	14	21	17	0.017
G1/4	0672 00 13	8	17	17	24	20	0.029
G3/8	0672 00 17	10	22	22	28	20	0.056
G1/2	0672 00 21	12	27	27	37	28	0.094

0682 Compact Silencer, Male BSPP Thread

Stainless steel 316L

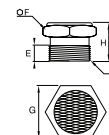

C		E	F	G	H	Kg
G1/8	0682 00 10	8	7	14	15	0.007
G1/4	0682 00 13	8	7	17	15	0.011
G3/8	0682 00 17	10	8	22	18	0.019
G1/2	0682 00 21	12	10	27	22	0.037
G3/4	0682 00 27	15	12	32	27	0.063
G1	0682 00 34	18	14	38	32	0.116

0683 Compact Silencer, Male NPT Thread

Stainless steel 316L

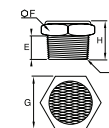



C		E	F	G	H	Kg
NPT1/8	0683 00 11	7	7	14	14	0.008
NPT1/4	0683 00 14	11	7	17	18	0.014
NPT3/8	0683 00 18	11	8	22	19	0.021
NPT1/2	0683 00 22	15	10	27	25	0.042



COMPRESSION FITTINGS

Compression Fittings

	Materials	Fluids	Maximum Pressure (bar)	Temperature		Performance in Aggressive Environments		Page
				Min.	Max.	Mechanical	Chemical	
Compression Fittings								
Brass Compression Fittings 	Brass	Compressed air, industrial fluids	550 (depending on the type of tubing used)	-60°C	+250°C	Excellent	Moderate	137
Stainless Steel Compression Fittings 	Stainless steel 316L	All fluids	400 (80 bar in aggressive environment)	-60°C	+250°C	Excellent	Excellent	151
Nickel-Plated brass Spigot Fittings 	Nickel-plated brass	Compressed air, industrial fluids	40 (depending on the type of nut used)	-40°C	+100°C	Good	Good	157

Compression Fitting Part Numbers

0105 14 27 99

Item Type

01XX: brass
18XX: stainless steel

Suffix

39: bonded seal
40: treated steel
60: nut
70: polymer nut
99: chemical nickel

Ø

04 = 4 mm
06 = 6 mm
...
20 = 20 mm
28 = 28 mm

Thread

10 = 1/8
13 = 1/4
...
21 = 1/2
27 = 3/4

PL Fitting Part Numbers

F3BPL 8/10 -1/4

Item Type

FBPL
F3BPL
HBPL
WBPL
...

Ø

2.7/4
4/6
6/8
7.5/10
8/10
10/12
11/14

Thread

BSPT:
1/8
1/4
3/8
...
Metric:
M10
M12

NPT: with adaptor
BSPT and NPT

Brass Compression Fittings / Stud Fittings



These "universal" fittings provide users with numerous connection options for a wide variety of tube materials without the need for tube threading or soldering guarantee excellent long-term sealing and performance.

Ø metric:
4 to 28 mm

Technical Characteristics

- **Compatible Fluids:** Water, machining oil, fuel, hydraulic oil, compressed air, chemical fluids, disinfectants
- **Working Pressure:** Vacuum to 550 bar
- **Working Temperature:** -60°C to +250°C without sealing washer, with metal tubing

Working temperature: -20°C to +100°C, with sealing washer and polyamide tubing.

Reliable performance is dependent upon the type of fluid conveyed, component materials and tubing being used.

Guaranteed for use with a vacuum of 755 mm Hg (99% vacuum).

Thread sealing must be guaranteed by user.

Advantages

- 22 configurations
- Excellent sealing due to the tightening of the olive onto the tube
- Metallic sealing for optimum service life, pressure and temperature ranges
- Connection of different types of tubing and hose: metal, polymer, steel, rubber, etc.
- Multiple tube diameters can be connected using the Legris reducer assembly system

Maximum Bore Diameters

The table below shows the recommended compatibility of tube size, BSPP male thread and maximum bore.

Tube O.D.	BSPP Thread	Max. Bore
4-5-6	G1/8	4
6-8-10	G1/4	7
10-12-14	G3/8	11
14-15-16-18	G1/2	14
18-20-22	G3/4	18
22-25-28	G1	24

Tube Length for Assembly

Minimum length of tube (L) between 2 fittings.

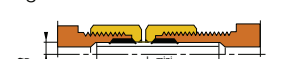

ØD	L (mm)	ØD	L (mm)	ØD	L (mm)
4	26.5	12	39	20	51
5	26	14	41	22	54
6	26	15	41	25	62
8	32	16	46.5	28	62
10	39	18	49.5		

Component Materials

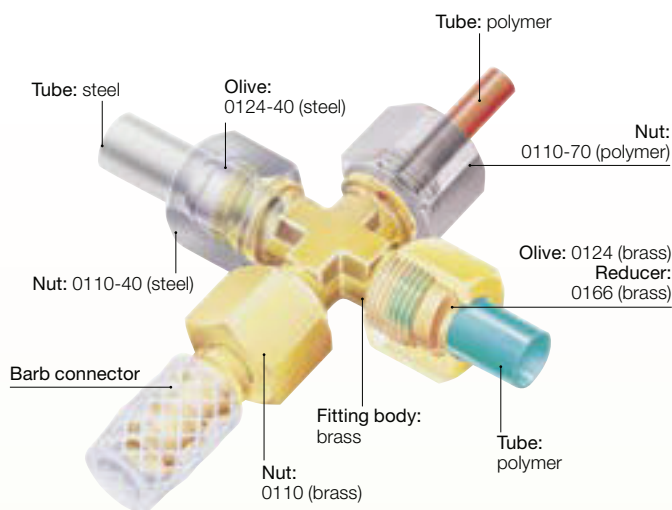

Regulations

- PED
- REACH
- RoHS

Regulations

CNOMO: E07.21.115N (for robotic equipment in the automotive industry)

DI: 97/23/EC (PED)

RG: 1907/2006 (REACH)

DI: 2002/95/EC (RoHS)

DI: 94/9/EC (ATEX)

Recommended Nut Tightening Torque

Tightening torque in daN.m =

maximum tightening torque of a 0110 nut and 0124 olive with copper, brass or steel tube.

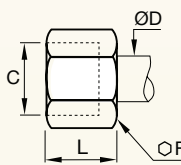

Nut 0110 and 0110..40

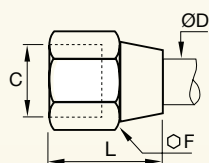

Nut 0110..60

Ø D (mm)	Ø F 0110	Ø F 0110..60	Max. daN.m Copper or Brass	Ø F 0110..40	Max. daN.m Steel
4	10	11	0.7	10	1.5
5	12	13	0.7	12	1.5
6	13	13	1.5	13	2.5
8	14	16	1.5	14	2.5
10	19	20	1.8	19	3
12	22	22	3	22	4.5
14	24	24	3.5	24	5.5
15	24	24	4	24	6
16	27	27	5	27	7
18	30	30	6	30	9
20	32	32	6	32	10
22	36	36	7	36	12
25	41	41	8	41	13
28	42		9		

Brass Compression Fittings / Stud Fittings

Installation

Cutting the Tube



Cut the polymer or metal tube square.

Preparing the Connection



For metal tubing, de-burr the tube prior to connection. Tube bending should be done before connection.



Slide the nut onto the tube; lubricate the threads on the body and nut along with the olive to facilitate tightening (for metal tubing as well). Fit the olive onto the end of the tube.

Connecting the Tube



Push the tube up against the shoulder of the fitting and hand tighten.

Final Assembly



Tighten the nut using a spanner or torque wrench to enable the olive to bite on the tube, the connection being completed when the recommended tightening torque is reached (see tables below).



It is recommended to use an insert in order to prevent tube creeping (diameter > 14mm)

Recommended Tube Type

Copper tube: copper which has been "cold rolled", cold drawn and in straight lengths.

Brass tube: in cold-rolled straight lengths (same working pressure as for copper tube).

"Coiled annealed" copper tube: reduces working pressure by 35%; must be avoided completely if vibration is present.

Steel tube: "thin wall" cold drawn, seamless, bright annealed and in straight lengths.

6 mm to 16 mm O.D.: max. wall thickness 1 mm
Above 16 mm O.D.: max. wall thickness 1.5 mm

Polyamide tube: semi-rigid

For rigid polyamide tube, multiply the figures in this table by 1.8.

Recommended Tube-Fitting Assembly Configurations

Assembled using Parker Legris brass olive and nut.

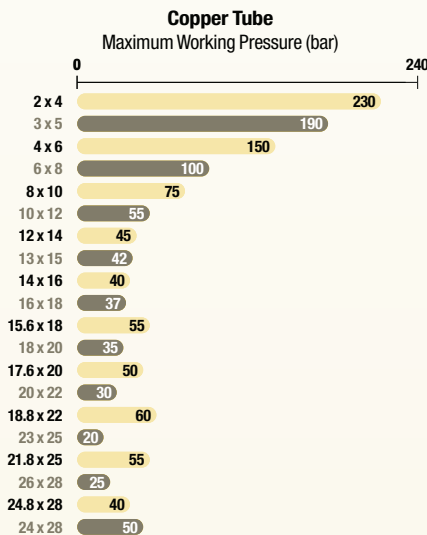

Assembled using Parker Legris steel olive and nut (nut type O110..40).

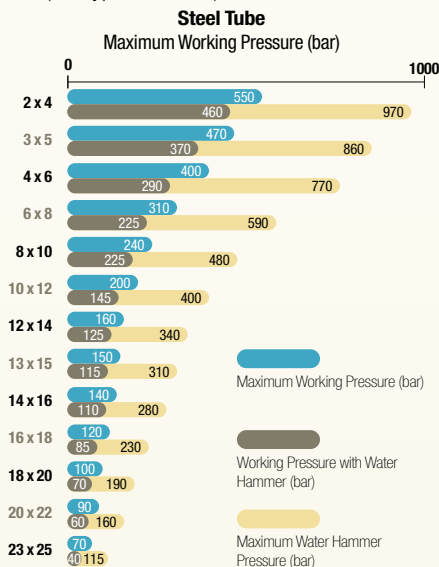

Assembled using Parker Legris brass olive and nut.

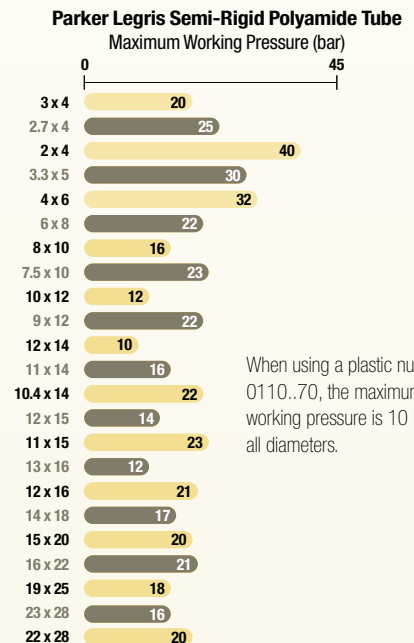

When using a plastic nut type O110..70, the maximum working pressure is 10 bar, for all diameters.

Working Pressure Coefficients for Semi-Rigid Polyamide Tubing

Temperature °C	-40°C / -15°C	-15°C / +30°C	+30°C / +50°C	+50°C / +70°C	+70°C / +100°C
Factor	1.8	1	0.68	0.55	0.31

Parker Legris brass compression fittings are not compatible with ammonia and its derivatives.

The above recommendations are given in good faith. However, since each application is different, it is advisable to undertake tests in actual working conditions.

Brass Compression Fittings / Stud Fittings

0105 Stud Fitting, Male BSPT Thread

Brass

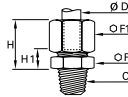

ØD	C		F	F1	H max	H1	Kg
4	R1/8	0105 04 10	10	10	17	7	0.012
	R1/8	0105 05 10	11	12	17.5	7.5	0.016
5	R1/4	0105 05 13	14	12	17.5	7.5	0.023
	R1/8	0105 06 10	11	13	18	7.5	0.017
6	R1/4	0105 06 13	14	13	18	7.5	0.024
	R3/8	0105 06 17	17	13	18	8.5	0.030
8	R1/8	0105 08 10	13	14	19.5	7	0.021
	R1/4	0105 08 13	14	14	19.5	7	0.026
8	R3/8	0105 08 17	17	14	20.5	8	0.032
	R1/8	0105 10 10	17	19	24	9	0.043
10	R1/4	0105 10 13	17	19	24	9	0.047
	R3/8	0105 10 17	17	19	24	9	0.048
	R1/2	0105 10 21	22	19	25	10	0.066
12	R1/4	0105 12 13	19	22	24	9	0.059
	R3/8	0105 12 17	19	22	24	9	0.060
	R1/2	0105 12 21	22	22	25	10	0.076
14	R1/4	0105 14 13	22	24	25	8	0.067
	R3/8	0105 14 17	22	24	25	8	0.068
	R1/2	0105 14 21	22	24	26	9	0.079
15	R3/4	0105 14 27	27	24	27	10	0.106
	R3/8	0105 15 17	22	24	25	8	0.066
	R1/2	0105 15 21	22	24	26	9	0.076
16	R1/4	0105 16 13	24	27	27	9.5	0.092
	R3/8	0105 16 17	24	27	27	9.5	0.093
	R1/2	0105 16 21	24	27	27	9.5	0.101
18	R3/4	0105 16 27	27	27	28	10.5	0.123
	R1/2	0105 18 21	27	30	30	10.5	0.128
	R3/4	0105 18 27	27	30	30	10.5	0.140
20	R1/2	0105 20 21	30	32	32	11	0.147
	R3/4	0105 20 27	30	32	32	11	0.160
	R1/2	0105 22 21	32	36	33	11	0.188
22	R3/4	0105 22 27	32	36	33	11	0.198
	R1	0105 22 34	36	36	33	11	0.229
	R3/4	0105 25 27	36	41	36	11	0.265
25	R1	0105 25 34	36	41	36	11	0.281
	R3/4	0105 28 27	41	42	36	11	0.273
28	R1	0105 28 34	41	42	36	11	0.282

Metric taper threads or Briggs (NPT threads) are available by special order, subject to minimum quantities.

0105 Stud Fitting, Male NPT Thread

Brass

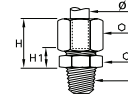

ØD	C		F	F1	H max	H1	Kg
6	NPT1/8	0105 06 11	11	13	18	7.5	0.018
	NPT1/4	0105 06 14	14	13	18	7.5	0.027
8	NPT1/8	0105 08 11	13	14	21	7	0.021
	NPT1/4	0105 08 14	14	14	18.5	7	0.026
10	NPT1/4	0105 10 14	17	19	24	9	0.047
	NPT3/8	0105 10 18	17	19	24	9	0.047
10	NPT1/2	0105 10 22	22	19	25	10	0.066

0101 Stud Fitting with Captive Sealing Washer, Male BSPP and Metric Thread

Brass, technical polymer



20 bar

ØD	C		E	F	F1	H max	H1	Kg
4	M5x0.8	0101 04 19	5	10	10	16.5	8	0.011
	G1/8	0101 04 10	6.5	13	10	16.5	8	0.016
5	G1/8	0101 05 10	6.5	13	12	17.5	8.5	0.019
	G1/8	0101 06 10	6.5	13	13	18	8.5	0.020
6	G1/4	0101 06 13	8	17	13	18	9.5	0.030
	G1/8	0101 08 10	6.5	13	14	19	8.5	0.021
8	G1/4	0101 08 13	8	17	14	19.5	9	0.031
	G3/8	0101 08 17	11	22	14	20	10.5	0.043
10	G1/4	0101 10 13	8	17	19	24	11	0.048
	G3/8	0101 10 17	11	22	19	24	11.5	0.061
10	G1/4	0101 12 13	8	19	22	24	11	0.061
	G3/8	0101 12 17	11	22	22	24	11.5	0.069
12	G1/2	0101 12 21	12	27	22	24	12	0.089
	G3/8	0101 14 17	11	22	24	25	10.5	0.075
14	G1/2	0101 14 21	12	27	24	25	11	0.093
	G3/8	0101 15 17	11	22	24	25	10.5	0.071
15	G1/2	0101 15 21	12	27	24	25	11	0.093
	G3/8	0101 16 17	11	22	27	27	12	0.092
16	G1/2	0101 16 21	12	27	27	27	12.5	0.110
	G1/2	0101 18 21	12	27	30	29.5	12.5	0.131
18	G3/4	0101 18 27	13	32	30	29.5	13	0.154
	G3/4	0101 20 27	13	32	32	31	13	0.166
20	G3/4	0101 22 27	13	32	36	32	13	0.197
	G1	0101 22 34	15	41	36	31	13.5	0.259
28	G1	0101 28 34	15	41	42	35.5	13.5	0.300

With pre-assembled polyamide washer

Sealing washers 0602 can be found in the sub-chapter "Adaptors and Manifolds".

Brass Compression Fittings / Stud Fittings

0101..39 Stud Fitting, with Bi-Material Seal, Male BSPP Thread

Brass, zinc plated steel with NBR seal

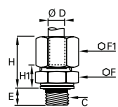

250 bar

ØD	C		E	F	F1	H max	H1	Kg
4	G1/8	0101 04 10 39	5.5	13	10	17.5	9	0.016
5	G1/8	0101 05 10 39	5.5	13	12	18.5	9.5	0.019
6	G1/8	0101 06 10 39	5.5	13	13	19	9.5	0.020
	G1/4	0101 06 13 39	7	17	13	19	10.5	0.030
8	G1/8	0101 08 10 39	5.5	13	14	20	9.5	0.022
	G1/4	0101 08 13 39	7	17	14	20.5	10	0.031
10	G3/8	0101 08 17 39	9.5	22	14	21.5	12	0.045
	G1/4	0101 10 13 39	7	17	19	25	12	0.048
12	G3/8	0101 10 17 39	9.5	22	19	25.5	13	0.062
	G1/4	0101 12 13 39	7	19	22	25	12	0.062
14	G3/8	0101 12 17 39	9.5	22	22	25	13	0.071
	G1/2	0101 12 21 39	10.5	27	22	25	13.5	0.091
15	G3/8	0101 14 17 39	9.5	22	24	26.5	12	0.074
	G1/2	0101 14 21 39	10.5	27	24	26.5	12.5	0.094
16	G3/8	0101 15 17 39	9.5	22	24	26.5	12	0.071
	G1/2	0101 15 21 39	10.5	27	24	26.5	12.5	0.094
18	G3/8	0101 16 17 39	9.5	22	27	28.5	13.5	0.093
	G1/2	0101 16 21 39	10.5	27	27	28.5	14	0.111
20	G1/2	0101 18 21 39	10.5	27	30	31	14	0.131
	G3/4	0101 18 27 39	11.5	32	30	31	14.5	0.156
22	G3/4	0101 20 27 39	11.5	32	32	32.5	14.5	0.167
	G1	0101 22 27 39	11.5	32	36	32.5	14.5	0.200
28	G1	0101 22 34 39	13	41	36	33	15.5	0.261
	G1	0101 28 34 39	13	41	42	37.5	15.5	0.301

Thread with bi-material seal

Bi-material sealing washers, part number 0139, can be found in the sub-chapter "Adaptors and Manifolds".

0101 Stud Fitting, Male Metric Thread

Brass

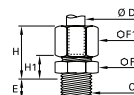

ØD	C		E	F	F1	H max	H1	Kg
4	M7x1	0101 04 55	6.5	10	10	16.5	7.5	0.012
	M8x1	0101 04 56	6.5	11	10	16.5	7.5	0.013
5	M8x1	0101 05 56	6.5	11	12	17.5	8	0.016
	M10x1	0101 05 60	6.5	14	12	17.5	8.5	0.020
6	M10x1	0101 06 60	6.5	14	13	18	8.5	0.021
	M10x1.5	0101 06 62	6.5	14	13	18	8.5	0.021
8	M12x1	0101 08 65	8	17	14	19.5	9	0.029
	M12x1.25	0101 08 66	8	17	14	19.5	9	0.029
10	M13x1.25	0101 08 68	8	17	14	19.5	9	0.030
	M14x1.25	0101 10 70	8	17	19	24	11	0.047
10	M14x1.5	0101 10 71	8	17	19	24	11	0.047
	M16x1.25	0101 10 74	9	19	19	24	11	0.052
12	M16x1.5	0101 10 75	9	19	19	24	11	0.051
	M18x1.5	0101 10 78	9	22	19	24	11.5	0.059
12	M16x1.5	0101 12 75	9	19	22	24	11	0.061
	M18x1.5	0101 12 78	9	22	22	24	11.5	0.070
14	M18x1.5	0101 14 78	9	22	24	25	10.5	0.073
	M20x1.5	0101 14 80	10	24	24	25	11	0.084
16	M20x1.5	0101 16 80	10	24	27	27	12.5	0.103
	M22x1.5	0101 16 82	10	27	27	27	12.5	0.112
18	M22x1.5	0101 18 82	10	27	30	29.5	12.5	0.131

Brass Compression Fittings / Stud Fittings

0114 Stud Fitting, Female BSPP Thread

Brass

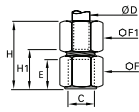

ØD	C		E	F	F1	H max	H1	Kg
4	G1/8	0114 04 10	9.5	14	10	26	16.5	0.020
	G1/4	0114 04 13	13.5	17	10	30	20.5	0.030
5	G1/8	0114 05 10	9.5	14	12	28	17	0.024
	G1/4	0114 05 13	13.5	17	12	31	21	0.032
6	G1/8	0114 06 10	9.5	14	13	28	17	0.025
	G1/4	0114 06 13	13.5	17	13	32	21	0.034
8	G3/8	0114 06 17	14	22	13	32	21.5	0.051
	G1/8	0114 08 10	9.5	14	14	29	16.5	0.026
8	G1/4	0114 08 13	13.5	17	14	33	20.5	0.035
	G3/8	0114 08 17	14	22	14	34	21	0.052
10	G1/4	0114 10 13	13.5	17	19	37	21.5	0.052
	G3/8	0114 10 17	14	22	19	37	22	0.069
10	G1/2	0114 10 21	18.5	27	19	42	26.5	0.099
	G1/4	0114 12 13	13.5	19	22	36	20.5	0.068
12	G3/8	0114 12 17	14	22	22	37	22	0.078
	G1/2	0114 12 21	18.5	27	22	42	26.5	0.109
12	G1/4	0114 14 13	13.5	22	24	36	18.5	0.084
	G3/8	0114 14 17	14	22	24	38	21	0.081
14	G1/2	0114 14 21	18.5	27	24	43	25.5	0.111
	G3/8	0114 15 17	14	22	24	38	21	0.077
15	G1/2	0114 15 21	18.5	27	24	43	25.5	0.109
	G1/4	0114 16 13	13.5	24	27	36	18	0.109
16	G3/8	0114 16 17	14	24	27	38	20.5	0.108
	G1/2	0114 16 21	18.5	27	27	44	26	0.129
18	G3/8	0114 18 17	14	27	30	39	19.5	0.141
	G1/2	0114 18 21	18.5	27	30	45	26	0.146
18	G3/4	0114 18 27	19.5	32	30	46	27	0.165
	G1/2	0114 20 21	18.5	30	32	44.5	24	0.173
20	G3/4	0114 20 27	19.5	32	32	47	26.5	0.174
	G3/4	0114 22 27	19.5	32	36	48	26.5	0.204

0109 Stud Elbow, Male BSPT Thread

Brass

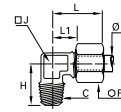

ØD	C		F	H	J	L max	L1	Kg
4	R1/8	0109 04 10	10	17	8	19	9.5	0.016
	R1/4	0109 04 13	10	20	10	19	11	0.025
5	R1/8	0109 05 10	12	17.5	8	21	11	0.019
	R1/4	0109 05 13	12	21.5	10	22	12	0.029
6	R1/8	0109 06 10	13	18	8	22	11	0.021
	R1/4	0109 06 13	13	21.5	10	22	12	0.030
8	R1/8	0109 08 10	14	18.5	10	28	15	0.028
	R1/4	0109 08 13	14	22	10	28	15	0.033
8	R3/8	0109 08 17	14	24	12	28	15	0.044
	R1/4	0109 10 13	19	25	12	30	14.5	0.053
10	R3/8	0109 10 17	19	25.5	12	30	14.5	0.059
	R1/2	0109 10 21	19	32	19	36	21	0.108
12	R1/4	0109 12 13	22	26	15	30	15	0.073
	R3/8	0109 12 17	22	27	15	30	15	0.077
12	R1/2	0109 12 21	22	32	19	36	21	0.114
	R3/8	0109 14 17	24	30	19	35	18	0.104
14	R1/2	0109 14 21	24	32	19	35	18	0.112
	R3/8	0109 15 17	24	30	19	35	18	0.101
15	R1/2	0109 15 21	24	32	19	35	18	0.107
	R3/8	0109 16 17	27	30	19	39	21	0.122
16	R1/2	0109 16 21	27	33.5	19	39	21	0.132
	R3/4	0109 16 27	27	36.5	23	41	23	0.189
18	R1/2	0109 18 21	30	35.5	23	41	21.5	0.181
	R3/4	0109 18 27	30	36.5	23	41	21.5	0.197
20	R1/2	0109 20 21	32	36.5	23	42	21.5	0.186
	R3/4	0109 20 27	32	38	23	42	21.5	0.203
22	R3/4	0109 22 27	36	40	27	50	30	0.293
	R1	0109 22 34	36	44	27	50	30	0.332
25	R1	0109 25 34	41	44	27	54	30	0.370
28	R1	0109 28 34	42	48	32	54	30	0.378

Metric taper threads or Briggs (NPT threads) are available by special order, subject to minimum quantities.

0109 Stud Elbow, Male NPT Thread

Brass

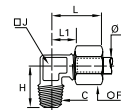

ØD	C		F	H	J	L max	L1	Kg
6	NPT1/8	0109 06 11	13	18	8	22	11	0.021
	NPT1/4	0109 06 14	13	21.5	10	22	12	0.030
8	NPT1/8	0109 08 11	14	18.5	10	28	15	0.027
	NPT1/4	0109 08 14	14	22	10	28	15	0.032
10	NPT1/4	0109 10 14	19	25	12	30	14.5	0.054

Brass Compression Fittings / Stud Fittings

0199 Stud Orientable Elbow, Male BSPP Thread

Brass, NBR

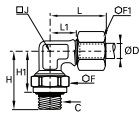

20 bar

ØD	C		F	F1	H	H1	H1 max	J	L max	L1	Kg
4	G1/8	0199 04 10	14	10	23	16	17	8	19	9.5	0.022
	G1/4	0199 04 13	19	10	30.5	22	23.5	10	19	11	0.043
6	G1/8	0199 06 10	14	13	23	16	17	8	22	11	0.027
	G1/4	0199 06 13	19	13	30.5	22	23.5	10	22	12	0.047
8	G1/8	0199 08 10	14	14	24	17	18	10	28	15	0.034
	G1/4	0199 08 13	19	14	30.5	22	23.5	10	28	15	0.050
	G3/8	0199 08 17	22	14	33.5	24	25.5	12	28	15	0.065
10	G1/4	0199 10 13	19	19	31	22.5	24	12	30	14.5	0.067
	G3/8	0199 10 17	22	19	33.5	24	25.5	12	30	14.5	0.079
14	G1/2	0199 14 17	27	19	40	29.5	31	19	37	22	0.136
	G3/8	0199 14 21	22	24	35.5	26	27.5	19	35	18	0.115
18	G1/2	0199 18 21	27	24	40	29	30.5	23	41	21.5	0.193
	G3/4	0199 18 27	32	30	43.5	32	33.5	23	41	21.5	0.224
22	G3/4	0199 22 27	32	36	45.5	34	36	32	51	31	0.381
	G1	0199 22 34	41	36	54	40.5	43	32	51	31	0.414

The body will orientate for positioning purposes.

0108 Stud Branch Tee, Male BSPT Thread

Brass

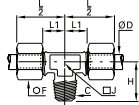

ØD	C		F	H	J	L/2	L1	Kg
4	R1/8	0108 04 10	10	17	8	19	9.5	0.025
	R1/8	0108 06 10	13	18	8	22	11	0.033
6	R1/4	0108 06 13	13	21.5	10	27	16	0.047
	R1/8	0108 08 10	14	18.5	10	28	15	0.045
8	R1/4	0108 08 13	14	22	10	28	15	0.048
	R3/8	0108 08 17	14	24	12	28	15	0.062
10	R1/4	0108 10 13	19	25	12	30	14.5	0.085
	R3/8	0108 10 17	19	25.5	12	30	14.5	0.092
12	R1/4	0108 12 13	22	26	15	30	15	0.114
	R3/8	0108 12 17	22	27	15	30	15	0.118
14	R3/8	0108 14 17	24	30	19	35	18	0.158
	R1/2	0108 14 21	24	32	19	35	18	0.169
16	R3/8	0108 16 17	27	30	19	39	21	0.192
	R1/2	0108 16 21	27	33.5	19	39	21	0.206
18	R1/2	0108 18 21	30	35.5	23	41	21.5	0.273
20	R3/4	0108 20 27	32	38	23	42	21.5	0.301
22	R3/4	0108 22 27	36	40	27	50	29	0.433

Metric taper threads or Briggs (NPT threads) are available by special order, subject to minimum quantities.

0103 Stud Run Tee, Male BSPT Thread

Brass

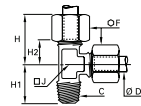

ØD	C		F	H max	H1	H2	J	Kg
4	R1/8	0103 04 10	10	19	17	9.5	8	0.025
	R1/8	0103 06 10	13	22	18	11	8	0.033
6	R1/4	0103 06 13	13	27	21.5	16	10	0.048
	R1/4	0103 08 13	14	28	22	15	10	0.050
10	R1/4	0103 10 13	19	30	25	14.5	12	0.085
12	R1/4	0103 12 13	22	30	26	15	15	0.114

Metric taper threads or Briggs (NPT threads) are available by special order, subject to minimum quantities.

0118..39 Single Banjo with Bi-Material Seal, Male BSPP Thread

Brass, zinc plated steel with NBR seal

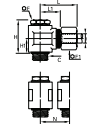

250 bar

ØD	C		F	F1	H	H1	L max	L1	N	Kg
4	G1/8	0118 04 10 39	14	10	23	9.5	24	14.5	17.5	0.040
5	G1/8	0118 05 10 39	14	12	23	9.5	25	14.5	17.5	0.042
	G1/8	0118 06 10 39	14	13	23	9.5	25	14.5	17.5	0.043
6	G1/4	0118 06 13 39	17	13	24	10	26	16	21	0.058
	G1/8	0118 08 10 39	14	14	23	9.5	28	15.5	17.5	0.055
8	G1/4	0118 08 13 39	17	14	24	10	28	15.5	21	0.059
	G3/8	0118 08 17 39	22	14	31.5	13.5	30	18	26.5	0.113
10	G1/4	0118 10 13 39	17	19	30	13	34	19	23	0.118
	G3/8	0118 10 17 39	22	19	31.5	13.5	34	19	26.5	0.128
12	G1/4	0118 12 13 39	17	22	33	14.5	34	19	23	0.128
	G3/8	0118 12 17 39	22	22	34.5	15	34	19	26.5	0.137
14	G1/4	0118 14 13 39	17	24	36	16	37	20.5	28	0.190
	G3/8	0118 14 17 39	22	24	37.5	16.5	37	20.5	28	0.196
16	G1/2	0118 15 21 39	27	24	39	16.5	38	20.5	32.5	0.207
	G1/2	0118 16 21 39	27	24	40	16.5	38	20.5	32.5	0.202
18	G1/2	0118 18 21 39	27	27	40	16.5	38	21	32.5	0.225
22	G1/2	0118 18 21 39	27	30	47	20	43	24.5	36	0.372
	G3/4	0118 22 27 39	32	36	54	22.5	45	24.5	39	0.467

With bi-material sealing washer

The bi-material sealing washers, part number 0139, can be found in the sub-chapter "Adaptors and Manifolds".

0119 Double Banjo with Captive Sealing Washer, Male BSPP Thread

Brass, technical polymer

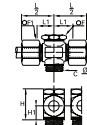

20 bar

ØD	C		F	F1	H	H1	L/2	L1	N	Kg
8	G1/4	0119 08 13	17	14	25	10	28	15.5	21	0.075
	G3/8	0119 08 17	22	14	32	13	30.5	18	26.5	0.135

Thread with pre-assembled washer

Sealing washers 0602 can be found in the sub-chapter "Adaptors and Manifolds".

0119..39 Double Banjo with Bi-Material Seal, Male BSP Thread

Brass, zinc plated steel with NBR seal

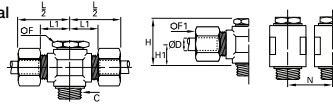

250 bar

ØD	C		F	F1	H	H1	L/2	L1	N	Kg
4	G1/8	0119 04 10 39	14	10	23	9.5	24	14.5	17.5	0.050
6	G1/8	0119 06 10 39	14	13	23	9.5	25	14.5	17.5	0.055
8	G1/8	0119 08 10 39	14	14	23	9.5	28	15.5	17.5	0.072
	G1/4	0119 08 13 39	17	14	24	10	28	15.5	21	0.076
10	G1/4	0119 10 13 39	17	19	30	13	34	19	23	0.156
12	G1/4	0119 12 13 39	17	22	33	14.5	34	19	23	0.180
14	G1/2	0119 14 21 39	27	24	39	16.5	38	20.5	32.5	0.256

Thread with pre-assembled washer

Bi-material sealing washers, part number 0139, can be found in the sub-chapter "Adaptors and Manifolds".

Customised Fittings

Working directly with its customers and based on its knowledge and experience, Parker Legris can design customised brass compression fittings for specific requirements using the customer's specifications.

The range of compression fittings also offers nickel chemical surface treatment in order to improve the corrosion resistance and chemical compatibility of the fittings (the model number of the fitting is then given the suffix 99).

The above recommendations are given in good faith. However, since each application is different, it is advisable to undertake tests in actual working conditions.



Brass Compression Fittings / Tube-to-Tube Fittings

0106 Equal Tube-to-Tube Connector

Brass

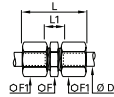

ØD		F	F1	L max	L1	Kg
4	0106 04 00	10	10	28	10	0.016
5	0106 05 00	11	12	31	11	0.023
6	0106 06 00	11	13	32	11	0.026
8	0106 08 00	13	14	36	10	0.031
10	0106 10 00	17	19	42	13	0.070
12	0106 12 00	19	22	42	13	0.091
14	0106 14 00	22	24	45	11	0.103
15	0106 15 00	22	24	45	11	0.096
16	0106 16 00	24	27	48	13	0.145
18	0106 18 00	27	30	53	14	0.190
20	0106 20 00	30	32	56	14	0.217
22	0106 22 00	32	36	60	14	0.281
28	0106 28 00	41	42	64	14	0.398

0102 Equal Elbow

Brass

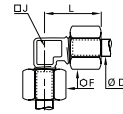

ØD		F	J	L max	Kg
4	0102 04 00	10	5	19	0.017
5	0102 05 00	12	8	21	0.025
6	0102 06 00	13	8	22	0.027
8	0102 08 00	14	10	28	0.038
10	0102 10 00	19	12	30	0.072
12	0102 12 00	22	15	30	0.097
14	0102 14 00	24	19	35	0.133
15	0102 15 00	24	19	35	0.122
16	0102 16 00	27	19	39	0.168
18	0102 18 00	30	23	41	0.236
20	0102 20 00	32	23	42	0.238
22	0102 22 00	36	27	50	0.375
28	0102 28 00	42	32	54.5	0.473

0116 Equal Bulkhead Connector

Brass

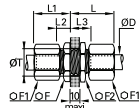

ØD		F	F1	F2	L max	L1 max	L2	L3	ØT min	Kg
4	0116 04 00	10	10	13	27	17	7	17	8.3	0.024
5	0116 05 00	13	12	14	28	18	7.5	17.5	10.3	0.035
6	0116 06 00	13	13	14	28	19	7.5	17.5	10.3	0.037
8	0116 08 00	14	14	17	29	20	7	17	12.3	0.045
10	0116 10 00	19	19	22	33	25	9	19	16.5	0.100
12	0116 12 00	22	22	22	33	25	9	19	18.5	0.121
14	0116 14 00	24	24	27	35	25	8	18	20.5	0.143
15	0116 15 00	24	24	24	35	25	8	18	20.5	0.134
16	0116 16 00	27	27	27	36	28	9.5	19.5	22.5	0.192
18	0116 18 00	27	30	30	40	30	10.5	20.5	24.5	0.238
20	0116 20 00	32	30	32	41	31	11	21	27.5	0.275
22	0116 22 00	36	36	36	42	32	11	21	30.5	0.379

0104 Equal Tee

Brass

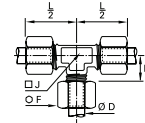

ØD		F	H	J	L/2	Kg
4	0104 04 00	10	9.5	8	19	0.029
5	0104 05 00	12	11	8	21	0.037
6	0104 06 00	13	11	8	22	0.040
8	0104 08 00	14	15	10	28	0.054
10	0104 10 00	19	14.5	12	30	0.104
12	0104 12 00	22	15	15	30	0.140
14	0104 14 00	24	18	19	35	0.190
15	0104 15 00	24	18	19	35	0.171
16	0104 16 00	27	21	19	39	0.245
18	0104 18 00	30	21.5	23	41	0.328
20	0104 20 00	32	21.5	23	42	0.336
22	0104 22 00	36	29	27	50	0.520

0142 Equal Y Piece with Mounting Boss

Brass

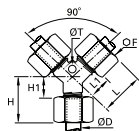

ØD		F	H max	H1	L max	L1	ØT	Kg
4	0142 04 00	10	16.5	7	26.5	17	4.2	0.031
6	0142 06 00	13	19.5	8.5	28	17	4.2	0.047
8	0142 08 00	14	21	8	30	17	6.2	0.059
10	0142 10 00	19	24.5	9	37.5	22	6.2	0.127
12	0142 12 00	22	26	11	38	23	6.2	0.168
14	0142 14 00	24	28	11	41.5	24.5	6.2	0.194

0107 Equal Cross

Brass

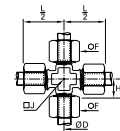

ØD		F	H	J	L/2	Kg
6	0107 06 00	13	11	8	22	0.052
8	0107 08 00	14	15	11	28	0.073
10	0107 10 00	19	14.5	14	30	0.141
12	0107 12 00	22	15	15	35	0.231
14	0107 14 00	24	18	20	35	0.244
16	0107 16 00	27	21	20	39	0.319
18	0107 18 00	30	21.5	25	41	0.436
22	0107 22 00	36	29	27	50	0.677

Brass Compression Fittings / Complementary Fittings

0166 3-Piece Reducer

Brass

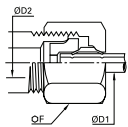

ØD1	ØD2		F	Kg
4	6	0166 04 06	13	0.011
5	6	0166 05 06	13	0.010
6	8	0166 06 08	14	0.012
6	10	0166 06 10	19	0.030
6	12	0166 06 12	22	0.043
6	14	0166 06 14	24	0.052
6	16	0166 06 16	27	0.077
8	10	0166 08 10	19	0.027
8	12	0166 08 12	22	0.040
8	14	0166 08 14	24	0.050
8	16	0166 08 16	27	0.076
10	12	0166 10 12	22	0.037
10	14	0166 10 14	24	0.045
10	16	0166 10 16	27	0.069
10	18	0166 10 18	30	0.096
10	20	0166 10 20	32	0.107
10	22	0166 10 22	36	0.146
12	16	0166 12 16	27	0.066
12	22	0166 12 22	36	0.142
14	16	0166 14 16	27	0.060
14	18	0166 14 18	30	0.084
14	25	0166 14 25	41	0.189
16	20	0166 16 20	32	0.086
16	22	0166 16 22	36	0.125
18	22	0166 18 22	36	0.118
20	25	0166 20 25	41	0.168

ØD1: tube to be fitted

ØD2: for a x mm fitting

Each of the above part numbers comprises:

- a reduction piece
- an olive, PN 0124
- a sleeve nut

0124 Brass Olive

Brass



ØD		Kg
4	0124 04 00	0.001
5	0124 05 00	0.001
6	0124 06 00	0.001
8	0124 08 00	0.001
10	0124 10 00	0.003
12	0124 12 00	0.004
14	0124 14 00	0.005
15	0124 15 00	0.004
16	0124 16 00	0.006
18	0124 18 00	0.007
20	0124 20 00	0.009
22	0124 22 00	0.012
25	0124 25 00	0.016
28	0124 28 00	0.017

0124..40 Steel Olive

Zinc-plated steel



ØD		Kg
4	0124 04 00 40	0.001
5	0124 05 00 40	0.001
6	0124 06 00 40	0.001
8	0124 08 00 40	0.001
10	0124 10 00 40	0.003
12	0124 12 00 40	0.004
14	0124 14 00 40	0.005
15	0124 15 00 40	0.004
16	0124 16 00 40	0.006
18	0124 18 00 40	0.007
20	0124 20 00 40	0.008
22	0124 22 00 40	0.010
25	0124 25 00 40	0.014

0111 BNA* Brass Olive

Brass



ØD		Kg
4	0111 04 00	0.001
5	0111 05 00	0.001
6	0111 06 00	0.001
8	0111 08 00	0.001
10	0111 10 00	0.002
12	0111 12 00	0.002
14	0111 14 00	0.003
15	0111 15 00	0.003
16	0111 16 00	0.004

*Bureau de Normalisation de l'Automobile

0110 Brass Nut

Brass



ØD	C		F	L	Kg
4	M8x1	0110 04 00	10	11	0.004
5	M10x1	0110 05 00	12	11	0.006
6	M10x1	0110 06 00	13	11	0.008
8	M12x1	0110 08 00	14	13	0.008
10	M16x1.5	0110 10 00	19	15	0.019
12	M18x1.5	0110 12 00	22	15	0.025
14	M20x1.5	0110 14 00	24	15	0.029
15	M20x1.5	0110 15 00	24	15	0.028
16	M22x1.5	0110 16 00	27	17	0.044
18	M24x1.5	0110 18 00	30	18	0.059
20	M27x1.5	0110 20 00	32	18	0.059
22	M30x1.5	0110 22 00	36	19	0.081
25	M33x1.5	0110 25 00			0.131
28	M36x1.5	0110 28 00			0.108

Brass Compression Fittings / Complementary Fittings

0110..40 Steel Nut

Zinc-plated steel



ØD	C		F	L	Kg
4	M8x1	0110 04 00 40	10	11	0.004
6	M10x1	0110 06 00 40	13	12	0.008
8	M12x1	0110 08 00 40	14	13.5	0.008
10	M16x1.5	0110 10 00 40	19	16	0.018
12	M18x1.5	0110 12 00 40	22	16.5	0.026
16	M22x1.5	0110 16 00 40	27	18	0.042
18	M24x1.5	0110 18 00 40	30	19	0.057
22	M30x1.5	0110 22 00 40	36	21.5	0.084

0110..60 Brass Long Nut

Brass



ØD	C		F	L	Kg
4	M8x1	0110 04 00 60	11	14.5	0.007
6	M10x1	0110 06 00 60	13	17.5	0.011
8	M12x1	0110 08 00 60	16	20	0.018
10	M16x1.5	0110 10 00 60	20	23	0.032
12	M18x1.5	0110 12 00 60	22	25	0.038

0110..70 Technical Polymer Nut-Olive

Technical polymer

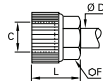

10 bar

ØD	C		F	L	Kg
4	M8x1	0110 04 00 70	8	13	0.001
6	M10x1	0110 06 00 70	11	15	0.002

NB: polymer nut-olives should not be used on metal tubes.

0122 Barb Connector for Hose

Brass

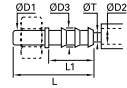

ØD1	ØD2	ØD3		L	L1	ØT min	Kg
4	4	6	0122 04 04	37.5	22.5	3	0.004
6	4	6	0122 06 04	37.5	22.5	3	0.005
	7	9	0122 06 07	37.5	22.5	6	0.007
8	6	8	0122 08 06	40	22.5	5	0.007
	7	9	0122 08 07	40	22.5	6	0.008
10	10	12.5	0122 08 10	40	22.5	9	0.012
	7	9	0122 10 07	43	22.5	6	0.010
12	10	12.5	0122 10 10	43	22.5	9	0.014
	10	12.5	0122 12 10	43	22.5	9	0.013
14	13	15	0122 12 13	50	29.5	12	0.018
	13	15	0122 14 13	52	29.5	12	0.019
15	16	18.5	0122 14 16	60.5	38	15	0.031
	13	15	0122 15 13	52	29.5	12	0.019
16	16	18.5	0122 15 16	60.5	38	15	0.032
	13	15	0122 16 13	53.5	29.5	12	0.021
18	16	18.5	0122 16 16	62	38	15	0.032
	16	18.5	0122 18 16	62	38	15	0.031
20	19	21.5	0122 18 19	62	38	18	0.040
	16	18.5	0122 20 16	64	38	15	0.034
22	19	21.5	0122 20 19	64	38	18	0.039
	19	21.5	0122 22 19	64	38	18	0.041
25	19	21.5	0122 25 19	70	38	18	0.048
	25	27.5	0122 25 25	70	38	24	0.054

0165 Barb Connector for Flexible Tubing

Brass

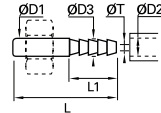

ØD1	ØD2	ØD3		L	L1	ØT min	Kg
4	4	4.3	0165 04 06	30	15	2	0.002
5	4	4.3	0165 05 06	30	15	2	0.003
	4	4.3	0165 06 06	30	15	2	0.003
6	6	6.4	0165 06 08	30	15	4	0.004
	8	8.4	0165 06 10	30	15	4	0.005
8	6	6.4	0165 08 08	32.5	15	4	0.006
	8	8.4	0165 08 10	32.5	15	6	0.006
10	10	10.7	0165 08 12	37.5	20	8	0.009
	8	8.4	0165 10 10	35.5	15	6	0.008
12	10	10.7	0165 10 12	40.5	20	8	0.010
	12	12.7	0165 10 14	40.5	20	8	0.012
14	10	10.7	0165 12 12	40.5	20	8	0.011
	12	12.7	0165 12 14	40.5	20	10	0.013
15	12	12.7	0165 14 14	42.5	20	10	0.015
	13	13.7	0165 15 16	42.5	20	11	0.015
16	13	13.7	0165 16 16	44	20	11	0.018

Brass Compression Fittings / Complementary Fittings

0126 Plug for Compression Fitting

Brass



ØD		L	Kg
4	0126 04 00	10	0.002
6	0126 06 00	10	0.003
8	0126 08 00	11.5	0.006
10	0126 10 00	13	0.010
12	0126 12 00	13	0.014
14	0126 14 00	13.5	0.020
18	0126 18 00	16	0.038
22	0126 22 00	18	0.003

The plug is used to blank off an outlet in a compression fitting, replacing the olive.
When an open outlet is required, simply dismantle and replace the plug with the tube olive, reusing the nut.
The plug is also reusable.

0125 Tube End Plug for Compression Fitting

Brass



ØD	C		F	L	L1	Kg
4	M8x1	0125 04 00	10	12	8	0.005
6	M10x1	0125 06 00	11	13.5	9.5	0.008
8	M12x1	0125 08 00	14	14	9	0.013
10	M16x1.5	0125 10 00	17	18	11	0.025

This plug enables unused tubes to be blanked off.
The male thread on the plug has the same pitch as the female thread on the sleeve nut of a standard Parker Legris fitting.
Therefore the plug screwed into the sleeve nut blanks off the tube.
To reopen the passage, simply unscrew the plug and fit the required coupler.
No further treatment of the tube is required.

0220 Hex Head Plug, Male BSPP and Metric Thread

Brass, technical polymer

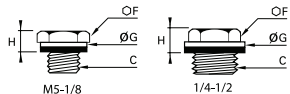

C		F	G	H1	Kg
M5x0.8	0220 19 00	8	8	5	0.002
G1/8	0220 10 00	14	14	7.5	0.011
G1/4	0220 13 00	17	17	7.5	0.020
G3/8	0220 17 00	17	22	8.5	0.024
G1/2	0220 21 00	22	27	10	0.041

Thread with pre-assembled sealing washer
M5: with screwdriver slot for tightening
Maximum allowable working pressure = 20 bar
Conforms to BNA 229 (with the exception of M5 model), BSPP thread, ISO ISO 228-1, Parallel metric thread, ISO NFE 03-054.

0220..39 Hex Head Plug with Bi-Material Seal, Male BSPP Thread

Brass, zinc plated steel with NBR seal

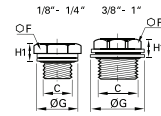

C		F	G	H	Kg
G1/8	0220 10 00 39	14	14	6.5	0.012
G1/4	0220 13 00 39	17	17	6.5	0.020
G3/8	0220 17 00 39	17	22	8	0.025
G1/2	0220 21 00 39	22	26	9	0.042
G3/4	0220 27 00 39	22	32	10	0.059
G1	0220 34 00 39	27	39.5	10.5	0.088

Plug with bi-material seal
Bi-material washers part number 0139 can be found in sub-chapter "Adaptors and Manifolds".
Part Number with suffix 39, maximum allowable working pressure: 250 bar

0120 Stud Standpipe, Male BSPT Thread

Brass

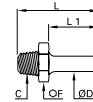

ØD	C		F	L	L1	Kg
4	R1/8	0120 04 10	11	25.5	14	0.007
5	R1/8	0120 05 10	11	26	14.5	0.007
6	R1/8	0120 06 10	11	26.5	15	0.008
	R1/4	0120 06 13	14	31	15	0.015
8	R1/8	0120 08 10	11	28.5	17	0.009
	R1/4	0120 08 13	14	33	17	0.016
	R3/8	0120 08 17	17	33.5	17	0.020
10	R1/4	0120 10 13	14	36	20	0.017
	R3/8	0120 10 17	17	36.5	20	0.022
	R1/2	0120 10 21	22	41	20	0.039
12	R1/4	0120 12 13	14	36	20	0.017
	R3/8	0120 12 17	17	36.5	20	0.022
	R1/2	0120 12 21	22	41	20	0.040
14	R3/8	0120 14 17	17	38	21.5	0.023
	R1/2	0120 14 21	22	42.5	21.5	0.042
15	R3/8	0120 15 17	17	38	21.5	0.023
	R1/2	0120 15 21	22	42.5	21.5	0.040
16	R3/8	0120 16 17	17	39.5	23	0.024
	R1/2	0120 16 21	22	44	23	0.042
18	R1/2	0120 18 21	22	44.5	23.5	0.042
	R3/4	0120 18 27	27	47.5	23.5	0.070
20	R3/4	0120 20 27	27	49	25	0.070
22	R3/4	0120 22 27	27	48.5	25.5	0.067
	R1	0120 22 34	36	52.5	25.5	0.117
28	R1	0120 28 34	36	57	30	0.140

Assembly: Barb Connectors

Our barb connectors 0122 and 0165 are designed to be used with different types of hose. They are secured using the nut and olive provided with the fitting.

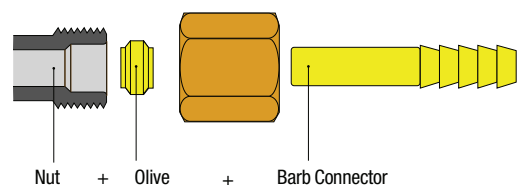

Brass Compression Fittings / Complementary Fittings

0112 Sleeve Nut for Compression Fitting, Male Metric Thread

Brass

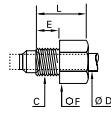

ØD	C		E	F	L	Kg
4	M8x1	0112 04 00	7	10	13	0.005
5	M10x1	0112 05 00	7.5	11	13.5	0.007
6	M10x1	0112 06 00	7.5	11	13.5	0.006
8	M12x1	0112 08 00	8	13	15	0.008
10	M16x1.5	0112 10 00	11	17	18	0.018
12	M18x1.5	0112 12 00	11	19	18	0.021
14	M20x1.5	0112 14 00	11	22	18	0.026

This product was designed to allow the tube to be fitted directly into the tapped port in a body using a standard Parker Legris olive.

For the corresponding drawings (cavity for Parker Legris olive), please consult us.

0128..39 Stud Standpipe with Bi-Material Seal, Male BSPP Thread

Brass, zinc plated steel with NBR seal

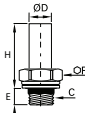

ØD	C		E	F	H	Kg
4	G1/8	0128 04 10 39	7.5	13	20	0.009
	G1/4	0128 04 13 39	9	17	22	0.015
6	G1/8	0128 06 10 39	7.5	13	21	0.010
	G1/4	0128 06 13 39	9	17	23	0.016
8	G1/8	0128 08 10 39	7.5	13	23	0.011
	G1/4	0128 08 13 39	9	17	25	0.017
	G3/8	0128 08 17 39	12	22	26	0.033
10	G1/4	0128 10 13 39	9	17	28	0.018
	G3/8	0128 10 17 39	12	22	29	0.034
	G1/2	0128 10 21 39	27	27	30	0.049
14	G3/8	0128 14 17 39	12	22	30.5	0.035
	G1/2	0128 14 21 39	27	27	31.5	0.049
18	G1/2	0128 18 21 39	27	27	33.5	0.051
	G3/4	0128 18 27 39	14	32	34.5	0.085
22	G3/4	0128 22 27 39	14	32	36.5	0.081
	G1	0128 22 34 39	16.5	41	38	0.123
28	G1	0128 28 34 39	16.5	41	42.5	0.147

With bi-material seal. Bi-material washers part number 0139 can be found in sub-chapter "Adaptors and Manifolds"

0151..39 Straight Male Orientable Adaptor, with Bi-Material Seal, Male BSPP Thread

Brass, NBR, zinc plated steel with NBR seal

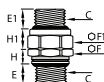

C		E	E1	F	F1	H	H1	Kg
G1/8	0151 10 10 39	5.5	7	13	14	6	6.5	0.017
G1/4	0151 13 13 39	7	8.5	17	19	6.5	9	0.036
G3/8	0151 17 17 39	9.5	9.5	22	22	9	9	0.056
G1/2	0151 21 21 39	10.5	10.5	27	27	10	10	0.082
G3/4	0151 27 27 39	11.5	11.5	32	32	11	10	0.122
G1	0151 34 34 39	13	13.5	41	41	12.5	10.5	0.217

With bi-material seal. Bi-material washers part number 0139 can be found in sub-chapter "Adaptors and Manifolds"

0168..39 Reducer, with Bi-Material Seal, Male BSPP Thread/Female BSPP and Metric Thread

Brass, zinc plated steel with NBR seal

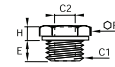

C1	C2		E	F	H	Kg
G1/8	M5x0.8	0168 10 19 39	8	14	4.5	0.009
G1/4	M5x0.8	0168 13 19 39	8	17	5	0.018
G1/4	G1/8	0168 13 10 39	8	17	5	0.012
G3/8	G1/8	0168 17 10 39	10	19	5	0.020
G3/8	G1/4	0168 17 13 39	10	19	5	0.013
G1/2	G1/8	0168 21 10 39	12	24	7.5	0.053
G1/2	G1/4	0168 21 13 39	12	24	7.5	0.044
G1/2	G3/8	0168 21 17 39	12	24	7.5	0.031
G3/4	G1/4	0168 27 13 39	12	32	9.5	0.100
G3/4	G3/8	0168 27 17 39	12	32	9.5	0.086
G3/4	G1/2	0168 27 21 39	12	32	9.5	0.065

With bi-material seal. Bi-material washers part number 0139 can be found in sub-chapter "Adaptors and Manifolds"

0127 Brass Tube Support for Polymer Tubing

Brass

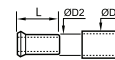

ØD1	ØD2		L	Kg
4	2	0127 04 00	11	0.001
		0127 04 25	413	0.001
4	2.7	0127 04 27	11	0.001
		0127 05 03	11	0.001
5	3.3	0127 05 00	11.5	1.000
		0127 06 00	11.5	0.001
8	5.5	0127 08 55	14	0.001
8	6	0127 08 00	14	0.001
10	7	0127 10 07	18	0.001
10	7.5	0127 10 75	18	0.001
10	8	0127 10 00	18	0.002
12	8	0127 12 08	26	0.002
12	9	0127 12 09	18	0.001
12	10	0127 12 00	18	0.001
14	11	0127 14 11	16	0.002
14	12	0127 14 00	18	0.003
15	12	0127 15 12	18	0.002
16	13	0127 16 13	18	0.003
18	14	0127 18 14	19.5	0.003
22	16	0127 22 16	21	0.005

This tube support guarantees good gripping, at high temperatures and pressures, by preventing collapsing of the tube.

Self-Fastening Hose Barb Connectors



This range of fittings is designed to meet the requirements of the automotive and robotics industries, combining as it does optimum CNOMO manufacturing quality, simple installation, reliable operation and a long service life.

Ø metric:
6 to 22 mm

Technical Characteristics

- **Compatible Fluids:** Coolants, compressed air
- **Working Pressure:** 0 to 16 bar
- **Working Temperature:** 0°C to +100°C (water)
-20°C to +70°C (air)

Tightening Torque, Type 0132	DN	6	8	10	14	18	22
	daN.m		0.7	1.5	1.8	3.5	6

Reliable performance is dependent upon the type of fluid conveyed and hose being used.

Advantages

- Easy to use
- Spark resistant
- Economic and time saving solution
- Mechanical properties proven for use in industrial robotic installations

Component Materials

Silicone-free

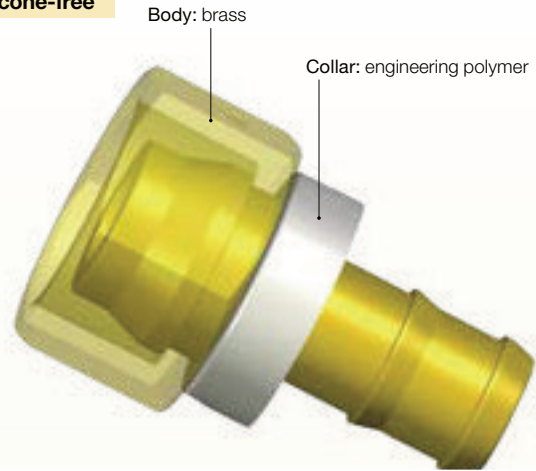

Self-Fastening Hose Assembly Machine

Machine designed to assemble a barb connector and a self-fastening NBR hose.

Machine part number:
0650 00 00 05



Tube Cutting and Positioning

Cut the hose square and position the barb connector on the mounting tool.

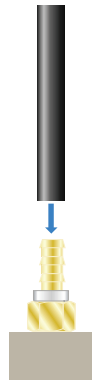

Press-Fitting the Tube

Activate the press-fit tool; connection is complete when the tube is fully home on the barb connector. This tool has been designed for use with 5 different diameters and is easy to operate.

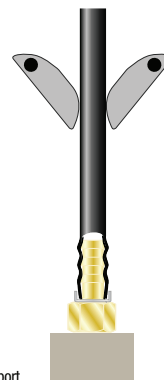

Regulations

Industrial:

- RoHS
- PED
- REACH

Self-fastening NBR hose is selected by nominal diameter; for example:

Barb Connector	O.D. (Tube)	Ø DN (Tube)	Self-Fastening NBR hose
0132 10 56	10	1/4	10..H 56...



Self-Fastening Hose Barb Connectors

0132 Self-Fastening Barb Connector for Brass Compression Fitting

Brass

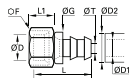

ØD	ØD1	ØD2		F	G	L	L1	ØT	Kg
6	6.3	13	0132 06 56	12	16.5	32.5	12.5	4.8	0.010
8	6.3	13	0132 08 56	14	16.5	29.5	11.5	4.8	0.015
10	6.3	13	0132 10 56	19	16.5	30	14	4.8	0.028
	9.5	16	0132 10 60	19	19.5	34	14	7.5	0.030
14	9.5	16	0132 14 60	24	19.5	35.5	15	7.5	0.050
	12.7	19	0132 14 62	24	23.5	39.5	15	10	0.054
18	12.7	19	0132 18 62	30	23.5	41.5	17	10	0.090
	15.9	23	0132 18 66	30	27	50	17	13.5	0.090
22	19.1	27	0132 22 69	36	30.5	56.5	17	16	0.130

Polymer collar

0133..39 Self-Fastening Bar Connector with Bi-Material Seal, Male BSPP Thread

Brass, zinc plated steel with NBR seal

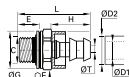

ØD1	ØD2	C		E	F	G	H	L	ØT	Kg
6.3	13	G1/8	0133 56 10 39	5.5	13	14	20	31.5	4.8	0.012
6.3	13	G1/4	0133 56 13 39	7	17	17	20	33.5	4.8	0.017
9.5	16	G1/4	0133 60 13 39	7	17	17	24	37.5	7.5	0.022
9.5	16	G3/8	0133 60 17 39	9.5	22	22	24	42.5	7.5	0.038
12.7	19	G3/8	0133 62 17 39	9.5	22	22	28	46.5	10	0.045
12.7	19	G1/2	0133 62 21 39	10.5	27	26	28	48.5	10	0.059
15.9	23	G1/2	0133 66 21 39	10.5	27	26	36.5	57	13.5	0.064
15.9	23	G3/4	0133 66 27 39	11.5	32	32	36.5	59	13.5	0.095
19.1	27	G3/4	0133 69 27 39	11.5	32	32	43	65.5	16	0.111

Thread with bi-material seal and polymer collar

Bi-material sealing washers part number 0139 can be found in the sub-chapter "Adaptors and Manifolds"

0134 Self-Fastening Barb Connector, Male BSPT Thread

Brass

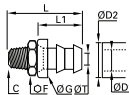

ØD1	ØD2	C		F	G	L	L1	ØT	Kg
6.3	13	R1/8	0134 56 10	14	16.5	32.5	20	4.8	0.015
6.3	13	R1/4	0134 56 13	14	16.5	37	20	4.8	0.020
9.5	16	R1/4	0134 60 13	14	19.5	41	24	7.5	0.022
9.5	16	R3/8	0134 60 17	19	19.5	41.5	24	7.5	0.036
12.7	19	R3/8	0134 62 17	19	23.5	45.5	28	10	0.038
12.7	19	R1/2	0134 62 21	22	23.5	50	28	10	0.062
15.9	23	R1/2	0134 66 21	22	27	58.5	36.5	13.5	0.056
15.9	23	R3/4	0134 66 27	27	27	60.5	36.5	13.5	0.101
19.1	27	R3/4	0134 69 27	27	30.5	67	43	16	0.108

Polymer collar

Stainless Steel Compression Fittings / Stud Fittings

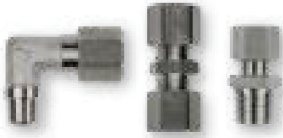

These "universal" compression fittings offer excellent resistance to environmental conditions and corrosive fluids. They are pressure and temperature-resistant and are able to withstand strong vibration and water hammer. Suitable for food fluids.

Ø metric:
6 to 16 mm

Technical Characteristics

- **Compatible Fluids:** Many fluids
- **Working Pressure:** Vacuum to 400 bar (80 bar in corrosive environments)
- **Working Temperature:** -60°C to +250°C with metal tubing

Tightening Torques	DN	6	8	10	12	16
	daN.m	2	3	4	6.5	9.5

Reliable performance is dependent upon the type of fluid conveyed and tubing being used.

Guaranteed for use with a vacuum of 755 mm Hg (99% vacuum).

Thread sealing must be guaranteed by user.

Advantages

- Excellent sealing and retention of the tube
- Metallic sealing guarantees maximum service life
- Connection of different types of pipes and tubes: metal, polymers, steel, rubber,...
- No tube support required for rigid and semi-rigid polyamide tubing below 12 mm
- Connection of several pipe diameters thanks to the Parker Legris assembly reduction system
- Range of associated accessories in 316L stainless steel

Maximum Bore Diameters

The table below shows the recommended compatibility of tube size, BSPP male thread and maximum bore.

Tube O.D	BSPP Thread	Max. Bore
6	G1/8	4
6-8-10	G1/4	7
10-12	G3/8	11
16	G1/2	14

Tube Length for Assembly

Minimum length of tube (L) between 2 fittings.



ØD	L mm	ØD	L mm
4	26.5	10	39
6	26	12	39
8	32	16	46.5

The use of Parker Legris stainless steel compression fittings is dependant on the tube material. Tables of recommended working pressure for the different tubes are shown below.

Recommended Tube Type

Semi-rigid polyamide or fluoropolymer tube

Stainless steel tube

"Thin Wall" cold-drawn seamless, annealed and passivated: wall thickness tolerance +/-0.1 mm.

For use with "thin wall" stainless steel tube from 6 mm to 16 mm O.D., maximum wall thickness 1 mm.

Recommended Tube/Fitting Assembly Configurations

Assembled using Parker Legris olive and nut in stainless steel, with a tube support.

Stainless steel tube

Stainless steel tube: in cold-rolled straight lengths

Coiled annealed stainless tube: reduces working pressure by 35%; do not use if there is vibration.

Component Materials

Silicone-free

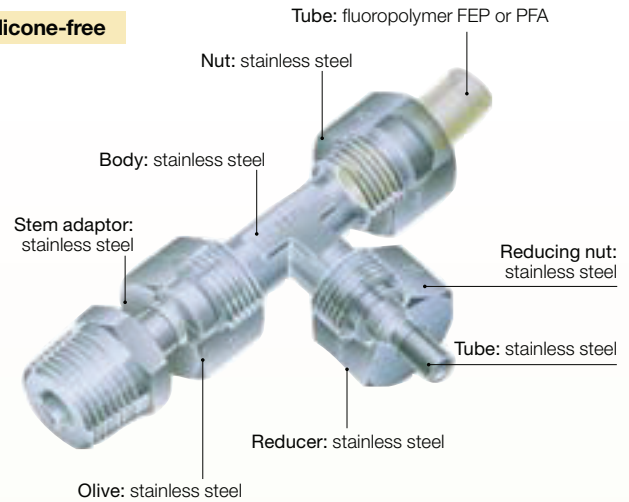

Regulations

- RoHS
- PED
- REACH
- 1935/2004

Stainless Steel Compression Fittings / Stud Fittings

Semi-Rigid Polyamide Tube

Maximum Working Pressure (bar)

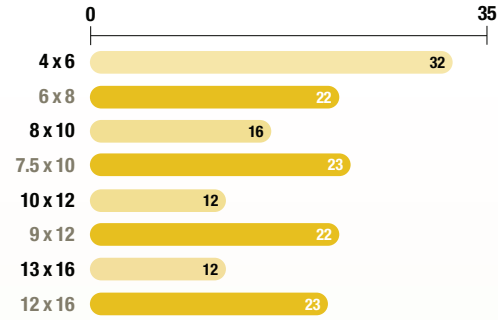

Stainless Steel Tube

Maximum Working Pressure (bar)

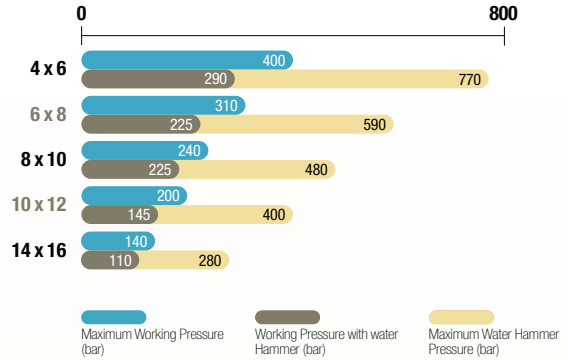

Working Pressure Coefficients for Semi-Rigid Tubing

Temperature °C	-40°C / -15°C	-15°C / +30°C	+30°C / +50°C	+50°C / +70°C	+70°C / +100°C
Factor	1.8	1	0.68	0.55	0.31

The above recommendations are given in good faith. However, since each application is different, it is advisable to undertake tests in actual working conditions.

Installations

Fitting

The fitting comprises three parts (body/olive/nut). For assembly procedure, please see Brass Compression Fitting page.

Diagram: Assembled Fitting

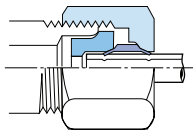

A very slight distortion of the tube appears; this shows the fitting has been correctly tightened.

Orientable Elbow Assembly

Elbow
1802

Adaptor
1820

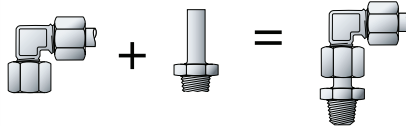

Customised Fittings

If our standard range does not meet your needs, Parker Legris can develop customised solutions for your applications.

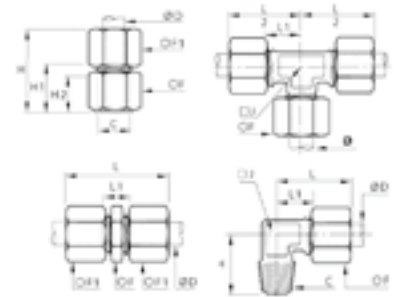

Stainless Steel Compression Fittings / Stud Fittings

1805 Stud Fitting, Male BSPT Thread

Stainless steel 316L

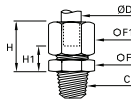

ØD	C		F	F1	H max	H1	Kg
6	R1/8	1805 06 10	12	13	19.5	7.5	0.017
	R1/4	1805 06 13	14	13	19.5	7.5	0.025
8	R1/8	1805 08 10	13	14	21	7	0.019
	R1/4	1805 08 13	14	14	21	7	0.024
	R1/4	1805 10 13	17	19	25.5	9	0.043
10	R3/8	1805 10 17	17	19	25.5	9	0.049
	R1/2	1805 10 21	22	19	26.5	10	0.076
12	R1/4	1805 12 13	19	22	26	9	0.054
	R3/8	1805 12 17	19	22	26	9	0.057
16	R1/2	1805 12 21	22	22	27	10	0.081
	R3/8	1805 16 17	24	27	28.5	9.5	0.086
	R1/2	1805 16 21	24	27	28.5	9.5	0.093

1809 Stud Elbow, Male BSPT Thread

Stainless steel 316L

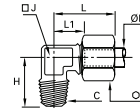

ØD	C		F	H	J	L max	L1	Kg
6	R1/8	1809 06 10	13	18	8	25.5	13.5	0.020
	R1/4	1809 06 13	13	23	10	25.5	13.5	0.029
8	R1/8	1809 08 10	14	20.5	10	28.5	14.5	0.026
	R1/4	1809 08 13	14	23	10	28.5	14.5	0.030
	R1/4	1809 10 13	19	25	12	32.5	16	0.051
10	R3/8	1809 10 17	19	25.5	12	32.5	16	0.057
	R1/2	1809 10 21	19	32	18	36.5	20	0.091
12	R1/4	1809 12 13	22	26	14	34	17	0.067
	R3/8	1809 12 17	22	27	14	34	17	0.070
16	R1/2	1809 12 21	22	32	18	37	20	0.098
	R3/8	1809 16 17	27	28.5	18	39.5	21	0.107
	R1/2	1809 16 21	27	31.5	18	39.5	21	0.114

1805 Stud Fitting, Male NPT Thread

Stainless steel 316L

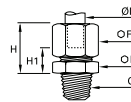

ØD	C		F	F1	H max	H1	Kg
6	NPT1/8	1805 06 11	12	13	19.5	7.5	0.018
	NPT1/4	1805 06 14	14	13	19.5	7.5	0.027
	NPT3/8	1805 06 18	19	13	20.5	8.5	0.033
8	NPT1/8	1805 08 11	13	14	21	7	0.021
	NPT1/4	1805 08 14	14	14	21	7	0.027
10	NPT1/4	1805 10 14	17	19	25.5	9	0.045
	NPT3/8	1805 10 18	19	19	25.5	9	0.055
	NPT1/2	1805 10 22	22	19	26.5	10	0.082
12	NPT1/4	1805 12 14	19	22	26	9	0.057
	NPT3/8	1805 12 18	19	22	26	9	0.060
	NPT1/2	1805 12 22	22	22	27	10	0.086

1809 Stud Elbow, Male NPT Thread

Stainless steel 316L

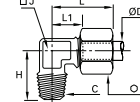

ØD	C		F	H	J	L max	L1	Kg
6	NPT1/4	1809 06 14	13	25.5	10	25.5	13.5	0.032
8	NPT1/8	1809 08 11	14	22	10	28.5	14.5	0.027
	NPT1/4	1809 08 14	14	25.5	10	28.5	14.5	0.032
10	NPT1/4	1809 10 14	19	27.5	12	32.5	16	0.053
	NPT3/8	1809 10 18	19	28	12	32.5	16	0.060
12	NPT1/2	1809 10 22	19	35	18	36.5	20	0.096
	NPT1/2	1809 12 22	22	35	18	37	20	0.101

1814 Stud Fitting, Female BSPP Thread

Stainless steel 316L

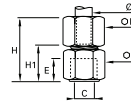

ØD	C		E	F	F1	H max	H1	Kg
6	G1/8	1814 06 10	7.5	14	13	29	17	0.024
	G1/4	1814 06 13	11	17	13	29	21	0.031
8	G1/4	1814 08 13	11	17	14	34.5	20.5	0.033
10	G3/8	1814 10 17	11.5	22	19	38.5	22	0.064
	G1/2	1814 10 21	15	27	19	43	26.5	0.094
12	G3/8	1814 12 17	11.5	22	22	39	22	0.073
	G1/2	1814 12 21	15	27	22	43.5	26.5	0.102
16	G1/2	1814 16 21	15	27	27	45	26	0.121

1820 Stud Standpipe, Male BSPT Thread

Stainless steel 316L

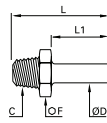

ØD	C		F	L	L1	Kg
6	R1/8	1820 06 10	12	26.5	15	0.009
	R1/4	1820 06 13	14	31	15	0.017
8	R1/8	1820 08 10	12	28.5	17	0.008
	R1/4	1820 08 13	14	33	17	0.016
10	R1/4	1820 10 13	14	36	20	0.016
	R3/8	1820 10 17	17	36.5	20	0.025
12	R1/2	1820 10 21	22	41	20	0.052
	R1/4	1820 12 13	14	36	20	0.016
16	R3/8	1820 12 17	17	36.5	20	0.023
	R1/2	1820 12 21	22	41	20	0.048
16	R3/8	1820 16 17	17	39.5	23	0.022
	R1/2	1820 16 21	22	44	23	0.039

1820 Stem Adaptor, Male NPT Thread

Stainless steel 316L

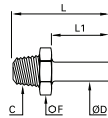

ØD	C		F	L	L1	Kg
8	NPT1/8	1820 08 11	12	28.5	17	0.009
	NPT1/4	1820 08 14	14	33	17	0.019
10	NPT1/4	1820 10 14	14	36	20	0.018
	NPT1/4	1820 12 14	14	36	20	0.019
12	NPT3/8	1820 12 18	19	36.5	20	0.028
	NPT1/2	1820 12 22	22	41	20	0.053

1806 Equal Tube-to-Tube Connector

Stainless steel 316L

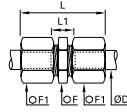

ØD		F	F1	L max	L1	Kg
6	1806 06 00	12	13	34.5	11	0.025
8	1806 08 00	13	14	38.5	10	0.029
10	1806 10 00	17	19	46	13	0.065
12	1806 12 00	19	22	47	13	0.085
16	1806 16 00	24	27	51	13	0.135

1816 Equal Bulkhead Connector

Stainless steel 316L

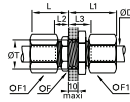

ØD		F	F1	L max	L1 max	L2	L3	ØT min	Kg
6	1816 06 00	13	13	28	19	7.5	17	10.5	0.034
8	1816 08 00	14	14	29	20	7	17	12.5	0.042
10	1816 10 00	19	19	33	25	9	19	16.5	0.093
12	1816 12 00	22	22	33	25	9	19	18.5	0.113
16	1816 16 00	27	27	36	28	9.5	19.5	22.5	0.179

1802 Equal Elbow

Stainless steel 316L

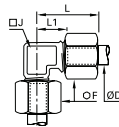

ØD		F	J	L max	L1	Kg
6	1802 06 00	13	8	25.5	13.5	0.027
8	1802 08 00	14	10	28.5	14.5	0.034
10	1802 10 00	19	12	32.5	16	0.070
12	1802 12 00	22	14	34	17	0.092
16	1802 16 00	27	18	39.5	21	0.151

1804 Equal Tee

Stainless steel 316L

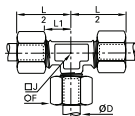

ØD		F	J	L/2	L1	Kg
6	1804 06 00	13	8	25.5	13.5	0.039
8	1804 08 00	14	10	28.5	14.5	0.049
10	1804 10 00	19	12	32.5	16	0.100
12	1804 12 00	22	14	34	17	0.133
16	1804 16 00	27	18	39.5	21	0.216

Stainless Steel Compression Fittings / Complementary Fittings

1866 3-Piece Reducer

Stainless steel 316L

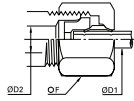

ØD1	ØD2		F	Kg
6	8	1866 06 08	14	0.011
	10	1866 06 10	19	0.027
8	10	1866 08 10	19	0.025

1824 Stainless Steel Olive

Stainless steel 316L



ØD		Kg
6	1824 06 00	0.002
8	1824 08 00	0.001
10	1824 10 00	0.003
12	1824 12 00	0.004
16	1824 16 00	0.005

1810 Stainless Steel Nut

Stainless steel 316L



ØD	C		F	L	Kg
6	M10x1	1810 06 00	13	11	0.007
8	M12x1	1810 08 00	14	13	0.008
10	M16x1.5	1810 10 00	19	15	0.017
12	M18x1.5	1810 12 00	22	15	0.024
16	M22x1.5	1810 16 00	27	17	0.041

1822 Barb Adaptor for Hose

Stainless steel 316L

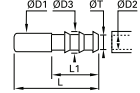

ØD1	ØD2	ØD3		L	L1	ØT min	Kg
6	7	9	1822 06 07	37.5	22.5	6	0.006
	6	8	1822 08 06	40	22.5	5	0.007
8	7	9	1822 08 07	40	22.5	6	0.007
	10	12.5	1822 08 10	40	22.5	9	0.011
10	7	9	1822 10 07	43	22.5	6	0.009
	10	12.5	1822 10 10	43	22.5	9	0.012
12	10	12.2	1822 12 10	43	22.5	9	0.012
	13	15	1822 12 13	50	29.5	13	0.015

1827 Stainless Steel Tube Support for Fluoropolymer Tubing

Stainless steel 316L

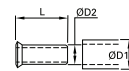

ØD1	ØD2		L	Kg
6	4	1827 06 00	11.5	0.001
8	6	1827 08 00	14	0.001
10	8	1827 10 00	18	0.001
12	9	1827 12 09	18	0.001
	10	1827 12 00	18	0.001
16	13	1827 16 13	18	0.002
	14	1827 16 00	18	0.002

This tube support is necessary when using fluoropolymer tubing at all temperatures compatible with the fitting/tubing assembly.

Nickel-Plated Brass Spigot Fittings



Particularly suitable for flexible tubing, PL fittings allow the tubes to be disassembled and reused.

Ø metric:
4 to 14 mm

Technical Characteristics

- **Compatible Fluids:** Compressed air
Other fluids: contact us
- **Working Pressure:** Vacuum to 18 bar with BPLM-M nut
Vacuum to 40 bar with BPLM nut
- **Working Temperature:** -40°C to +100°C

Tightening Torque (Nm)	M5 x0.8	M6 x1	1/8	1/4	3/8	1/2
BSPT Thread			8	12	14	16
BSPP Thread with "O" ring			1.2	1.5	2.5	3.5
BSPP Thread with metal sleeve			5	8	10	12
Metric Thread	0.8	0.8				

Reliable performance is dependent upon the type of fluid conveyed, component materials and tubing being used.

Guaranteed for use with a vacuum of 755 mm Hg (99% vacuum).

For use with fire-proof tubing: please consult us.

Component Materials

Silicone-free

Body: nickel-plated brass

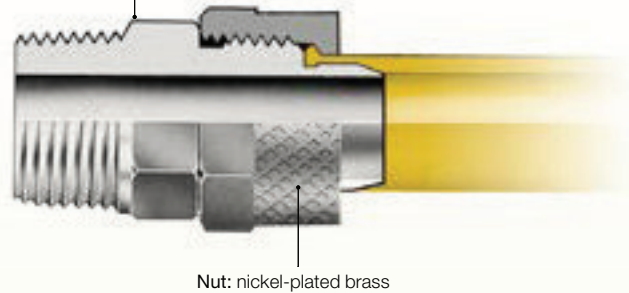

Nut: nickel-plated brass

Advantages

- Full flow sealing system
- Compatible with flexible and semi-rigid tubes (polyurethane, polyamide, polyethylene, fluoropolymers, etc.)
- Reliable direct sealing system without the use of a seal or olive
- Nickel-plated for increased corrosion resistance

Installation

Cutting the Tube



Cut the polymer tube square.

Preparing the Connection



Slide the nut onto the tube.

Connecting the Tube



Push the tube home into the body of the fitting.

Final Assembly



Tighten the nut by hand (in the case of soft tubing) or using a spanner (for semi-rigid tubing) until it comes into contact with the end stop.

F3BPL Stud Fitting, Male BSPT Thread

Nickel-plated brass

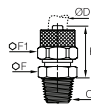

ØD	C		F	F1	H	Kg
2.7x4	R1/8	F3BPL2.7/4-1/8	12	8	16	0.009
4x6	R1/8	F3BPL4/6-1/8	12	12	19.5	0.016
	R1/4	F3BPL4/6-1/4	14	12	20	0.025
	R1/8	F3BPL6/8-1/8	12	14	19.5	0.019
6x8	R1/4	F3BPL6/8-1/4	14	14	20	0.026
	R3/8	F3BPL6/8-3/8	17	14	20	0.030
8x10	R1/4	F3BPL8/10-1/4	14	16	21.5	0.031
	R3/8	F3BPL8/10-3/8	17	16	21.5	0.043
10x12	R3/8	F3BPL10/12-3/8	17	18	23	0.036
11x14	R3/8	F3BPL11/14-3/8	22	22	23.5	0.061

Compatible with BPLM-M nut only

F4BPL Stud Fitting, Male BSPP Thread

Nickel-plated brass, NBR

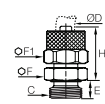

ØD	C		E	F	F1	H	Kg
4x6	G1/8	F4BPL4/6-1/8	6	13	12	19.5	0.031
6x8	G1/4	F4BPL6/8-1/4	8	16	14	20	0.033

Compatible with BPLM-M nut only

Nickel-Plated Brass Spigot Fittings

F8BPL Stud Fitting, Male Metric Thread

Nickel-plated brass, NBR

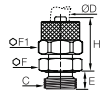

ØD	C		E	F	F1	H	Kg
6x8	M10x1	F8BPL6/8M10	8	14	13	20	0.025
	M12x1.25	F8BPL6/8M12	8	17	14	28	0.028

Compatible with BPLM nut only.
These fittings are supplied with a copper seal.
Maximum working pressure: 40 bar

C8BPL-1 Stud Elbow, Male Metric Thread

Nickel-plated brass, NBR

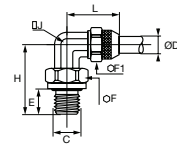

ØD	C		E	F	F1	H	J	L	Kg
6x8	M10x1	C8BPL6/8M10	6.5	14	14	22	10	23	0.030
	M12x1.25	C8BPL6/8M12X125	8	17	14	25	10	23	0.035

These fittings are supplied with nitrile seals.
Compatible with BPLM-M nut only.

C3BPL Stud Elbow, Male BSPT Thread

Nickel-plated brass

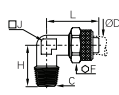

ØD	C		F	H	J	L	Kg
2.7x4	R1/8	C3BPL2.7/4-1/8	8	17	8	19.5	0.018
4x6	R1/8	C3BPL4/6-1/8	12	17	8	22.5	0.022
	R1/4	C3BPL4/6-1/4	12	20	10	22.5	0.031
6x8	R1/8	C3BPL6/8-1/8	14	17	10	22.5	0.029
	R1/4	C3BPL6/8-1/4	14	20	10	22.5	0.031
7.5x10	R3/8	C3BPL6/8-3/8	14	22.5	11	24	0.064
	R1/4	C3BPL7.5/10-1/4	16	22.5	12	28	0.057
8x10	R1/4	C3BPL8/10-1/4	16	21.5	11	25.5	0.057
	R3/8	C3BPL8/10-3/8	16	22.5	11	25.5	0.057
10x12	R3/8	C3BPL10/12-3/8	18	24.5	14	30	0.060
11x14	R3/8	C3BPL11/14-3/8	22	28	14	34	0.075

Compatible with BPLM-M nut only

R3BPL Stud Run Tee, Male BSPT Thread

Nickel-plated brass

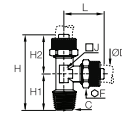

ØD	C		F	H	H1	H2	J	Kg
4x6	R1/8	R3BPL4/6-1/8	12	39.5	17	22.5	8	0.035
	R1/4	R3BPL4/6-1/4	12	43.5	21	22.5	10	0.048

Compatible with BPLM-M nut only

S3BPL Stud Branch Tee, Male BSPT Thread

Nickel-plated brass

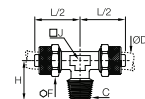

ØD	C		F	H	J	L/2	Kg
4x6	R1/8	S3BPL4/6-1/8	12	17	8	22.5	0.035
	R1/4	S3BPL4/6-1/4	12	20.5	10	22.5	0.047

Compatible with BPLM-M nut only

C4BPL Stud Elbow, Male BSPP Thread

Nickel-plated brass, NBR

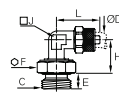

ØD	C		E	F	F1	H	J	L	Kg
4x6	G1/4	C4BPL4/6-1/4	8	17		25	10	23.5	0.066
6x8	G1/4	C4BPL6/8-1/4	8	17	14	25	10	23.5	0.068

These fittings are supplied with nitrile seals.
Compatible with BPLM-M nut only.

COR4BPL Single Banjo, Male BSPP Thread

Nickel-plated brass, treated steel, NBR

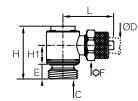

ØD	C		E	F	H	H1	L	Kg
4x6	G1/8	COR4BPL4/6-1/8	6.5	12	25.5	9	24	0.069
	G1/4	COR4BPL4/6-1/4	8	12	31.5	10	26	0.097
6x8	G1/4	COR4BPL6/8-1/4	8	14	31.5	10	26	0.101
	G1/8	COR4BPL6/8-1/8	6.5	14	25.5	9	24	0.073

These parts are supplied with peripheral seals.
The banjo bolt is made of steel.
Compatible with BPLM-M nut only.

Nickel-Plated Brass Spigot Fittings

HBPL Equal Tube-to-Tube Connector

Nickel-plated brass

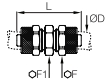

ØD		F	F1	L	Kg
2.7x4	HBPL2.7/4	8	8	26	0.010
4x6	HBPL4/6	12	12	34.5	0.021
6x8	HBPL6/8	14	14	35	0.030
8x10	HBPL8/10	14	16	38	0.043
10x12	HBPL10/12	17	18	41	0.056

Compatible with BPLM-M nut only

JBPL Equal Tee

Nickel-plated brass

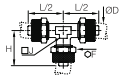

ØD		F	H	J	L/2	Kg
4x6	JBPL4/6	12	22.5	8	22.5	0.042
6x8	JBPL6/8	14	22.5	10	22.5	0.057

Compatible with BPLM-M nut only

WBPL Equal Bulkhead Connector

Nickel-plated brass

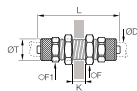

ØD		F	F1	K max	L	ØT	Kg
4x6	WBPL4/6	14	12	10.5	48	10	0.030
6x8	WBPL6/8	16	14	10.5	48	12	0.040
8x10	WBPL8/10	17	16	8.5	50	14	0.057

Compatible with BPLM-M nut only

BPLM Nut

Nickel-plated brass

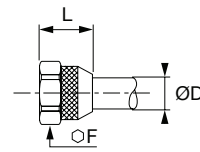

ØD	C		E	F	L	Kg
2.7x4	M6x0.50	BPL4M	6	8	8	0.003
4x6	M8x0.75	BPL6M	6.5	9	9	0.006
6x8	M12x1	BPL8M	7.5	14	10.5	0.009
8x10	M14x1	BPL10M	8	16	11.5	0.014

Maximum working pressure: 40 bar

BPLM-M Nut

Nickel-plated brass



ØD	C		F	L	Kg
4x6	M8x0.75	BPL6M-1	9	9	0.006
6x8	M12x1	BPL8M-1	14	10.5	0.008
8x10	M14x1	BPL10M-1	16	11.5	0.012

Brass, Stainless Steel, Composite Spigot Fittings

MV Female Stud Fitting

Brass



ØD	C		HEX	L
4x6	G1/8	MV10/06	14	23
	G1/4	MV13/06	17	25
6x8	G1/4	MV13/08	17	25

EV Stud Fitting

Brass

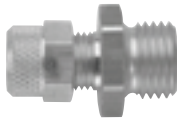

ØD	C		HEX	L	Version
3x4	M5	EV05/04	7	20	Brass
3x5	M5	EV05/05	7	20	Brass
4x6	M5	EV05/06	8	21	Brass
	G1/8	EV10/06	12	25	Brass
6x8	G1/8	EV10/08	14	24	Brass
4x6	G1/4	EV13/06	17	26	Brass
6x8	G1/4	EV13/08	17	26	Brass
8x10	G1/4	EV13/10	17	31	Brass
9x12	G1/4	EV13/12	17	31	Brass
	G3/8	EV17/12	19	31	Brass

EV Stud Fitting

Stainless steel

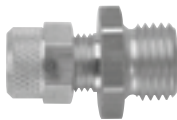

ØD	C		HEX	L	Version
3x4	M5	EV05/04R	7	20	AISI 303
3x5	M5	EV05/05R	7	20	AISI 303
4x6	M5	EV05/06R	8	21	AISI 303
	G1/8	EV10/06R	12	25	AISI 303
6x8	G1/8	EV10/08R	14	24	AISI 303

EV Plastic Screw Connector

POM or CHEM

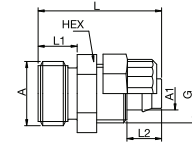

ØD	C		HEX	G	L	L1	L2	Version
4x6	G1/4	EV13/06DX	14	M 10 x 1	25	8	13	POM
6x8	G1/4	EV13/08DX	14	M 12 x 1	25	8	13	POM
4x6	G1/4	EV13/06FX	14	M 10 x 1	25	8	13	CHEM
6x8	G1/4	EV13/08FX	14	M 12 x 1	25	8	13	CHEM

EK Panel Mount, Plastic Hose Connection

POM or CHEM

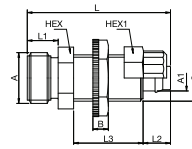

ØD	C		HEX	HEX1	B	G	L	L1	L2	L3	Version
4x6	G1/4	EK13/06DX	14	14	4	M 10 x 1	37	7	8	18	POM
6x8	G1/4	EK13/08DX	14	17	4	M 12 x 1	37	8	8	18	POM
4x6	G1/4	EK13/06FX	14	14	4	M 10 x 1	37	7	8	18	CHEM
6x8	G1/4	EK13/08FX	14	17	4	M 12 x 1	37	8	8	18	CHEM

A close-up photograph of a metal manifold or adapter, showing its intricate structure and texture. The image is overlaid with a fine grid pattern. The lighting is warm and focused on the central part of the component.

ADAPTORS AND MANIFOLDS

Adaptors and Manifolds

	Materials	Fluids	Maximum Pressure (bar)	Temperature		Performance in Aggressive Environments		Page
				Min.	Max.	Mechanical	Chemical	
Adaptors and Manifolds								
Nickel-Plated Brass Adaptors 	Nickel-plated brass	Compressed air	60	-10°C	+80°C	Good	Moderate	163
Brass Adaptors 	Brass	Compressed air	200	-40°C	+150°C	Good	Moderate	168
Stainless Steel Adaptors 	316L stainless steel	All fluids	200	-20°C	+180°C	Excellent	Excellent	173
Manifolds 	Anodised aluminium, brass	Compressed air	20	-10°C	+80°C	Excellent	Good	176
Plugs 	Brass, nickel-plated brass, stainless steel, steel	All fluids (depending on materials)	200	-60°C	+180°C	Excellent	Moderate to excellent	178
Accessories 	FKM, copper, polymer	All fluids (depending on materials)	250	-250°C	+260°C		Excellent	182

Nickel-Plated Brass Adaptors

0912 Equal Stud Elbow, Female BSPP and Metric Thread

Nickel-plated brass

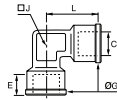

C		E	G	J	L	Kg
M5x0.8	0912 00 19	4	8	9	11	0.007
G1/8	0912 00 10	8	13	10	18.5	0.015
G1/4	0912 00 13	11.5	17	12	22.5	0.029
G3/8	0912 00 17	11.5	21	15	25.5	0.043
G1/2	0912 00 21	14	26	19	30	0.073
G3/4	0912 00 27	16.5	32	22	35.5	0.106
G1	0912 00 34	18	38.5	28	40.5	0.165

0921 Equal Stud Elbow, Male/Female and Metric Thread

Nickel-plated brass

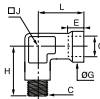

C		E	G	H	J	L	Kg
M5x0.8	0921 00 19	4	8	11.5	9	11	0.007

0913 Equal Stud Elbow, Male BSPT/ Female BSPP Thread

Nickel-plated brass

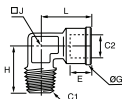

C1	C2		E	G	H	J	L	Kg
R1/8	G1/8	0913 00 10	8	13	17	10	18.5	0.012
R1/4	G1/4	0913 00 13	11.5	17	22.5	12	22.5	0.025
R3/8	G3/8	0913 00 17	11.5	21	25.5	15	25.5	0.040
R1/2	G1/2	0913 00 21	14	26	30	19	30	0.064
R3/4	G3/4	0913 00 27	16.5	32	34.5	22	35.5	0.098
R1	G1	0913 00 34	18	38.5	40.5	28	40.5	0.162

0914 Equal Stud Elbow, Male BSPT Thread

Nickel-plated brass

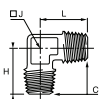

C		H	J	L	Kg
R1/8	0914 00 10	17	10	17	0.010
R1/4	0914 00 13	22.5	12	22.5	0.022
R3/8	0914 00 17	25.5	15	25.5	0.034
R1/2	0914 00 21	30	19	30	0.057
R3/4	0914 00 27	34.5	22	34.5	0.093
R1	0914 00 34	40.5	28	40.5	0.157

0910 Equal Y, Female BSPP Thread

Nickel-plated brass

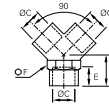

C		E	F	H	Kg
G1/8	0910 00 10	8	13	12	0.019
G1/4	0910 00 13	11	17	14	0.033
G3/8	0910 00 17	11.5	20	16	0.046
G1/2	0910 00 21	14	25	19	0.085

0911 Equal Y, Male BSPT/Female BSPP Thread

Nickel-plated brass

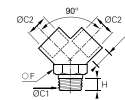

C1	C2		E	F	H	Kg
R1/8	G1/8	0911 00 10	8	13	8	0.022
R1/4	G1/4	0911 00 13	11	17	11	0.038
R3/8	G3/8	0911 00 17	11.5	20	11.5	0.051
R1/2	G1/2	0911 00 21	14	25	14	0.105

0915 Equal Tee, Female BSPP and Metric Thread

Nickel-plated brass

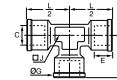

C		E	G	H	J	L/2	Kg
M5x0.8	0915 00 19	5	8	11	9	11	0.010
G1/8	0915 00 10	8	13	18.5	10	18.5	0.021
G1/4	0915 00 13	11	17	22.5	12	22.5	0.042
G3/8	0915 00 17	11.5	21	25.5	15	25.5	0.062
G1/2	0915 00 21	14	26	30	19	30	0.097
G3/4	0915 00 27	16.5	32	35.5	22	35.5	0.145
G1	0915 00 34	18	38.5	40.5	28	40.5	0.238

0916 Equal Stud Branch Tee, Male BSPT/Female BSPP Thread

Nickel-plated brass

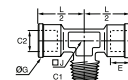

C1	C2		E	G	H	J	L/2	Kg
R1/8	G1/8	0916 00 10	8	13	17	10	18	0.019
R1/4	G1/4	0916 00 13	11	17	22.5	12	22.5	0.038
R3/8	G3/8	0916 00 17	11.5	21	25.5	15	25.5	0.058
R1/2	G1/2	0916 00 21	14	26	30	19	30	0.091
R3/4	G3/4	0916 00 27	16.5	32	34.5	22	35	0.139

Nickel-Plated Brass Adaptors

0917 Equal Stud Run Tee, Female BSPP/Male BSPT Thread

Nickel-plated brass

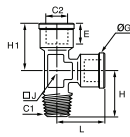

C1	C2		E	G	H	H1	J	L	Kg
R1/8	G1/8	0917 00 10	8	13	17	18.5	10	18.5	0.019
R1/4	G1/4	0917 00 13	11	17	22.5	22.5	12	22.5	0.038
R3/8	G3/8	0917 00 17	11.5	21	25.5	25.5	15	25.5	0.058
R1/2	G1/2	0917 00 21	14	26	30	30	19	30	0.089
R3/4	G3/4	0917 00 27	16.5	32	34.5	35.5	22	35.5	0.136

0927 Equal Tee, Male BSPT Thread

Nickel-plated brass

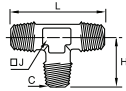

C			H	J	L	Kg
R1/8	0927 00 10		17	10	34	0.013
R1/4	0927 00 13		22.5	12	45	0.032
R3/8	0927 00 17		25.5	15	51	0.056
R1/2	0927 00 21		30	19	60	0.079
R3/4	0927 00 27		34.5	22	69	0.130

0928 Equal Stud Branch Tee, Male BSPT/ Female BSPP Thread

Nickel-plated brass

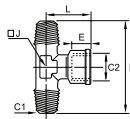

C1	C2		E	H	J	L	Kg
R1/8	G1/8	0928 00 10	8	34	10	18.5	0.016
R1/4	G1/4	0928 00 13	11	45	12	22.5	0.035
R3/8	G3/8	0928 00 17	11.5	51	15	25.5	0.053
R1/2	G1/2	0928 00 21	14	60	19	30	0.086
R3/4	G3/4	0928 00 27	16.5	69	22	35.5	0.236

0932 Equal Stud Run Tee, Male BSPT/Female BSPP Thread

Nickel-plated brass

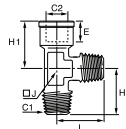

C1	C2		E	H	H1	J	L	Kg
R1/8	G1/8	0932 00 10	8	17	18.5	10	17	0.016
R1/4	G1/4	0932 00 13	11	22.5	22.5	12	22.5	0.035
R3/8	G3/8	0932 00 17	11.5	25.5	25.5	15	25.5	0.053
R1/2	G1/2	0932 00 21	14	30	30	19	30	0.091
R3/4	G3/4	0932 00 27	16.5	34.5	35.5	22	34.5	0.080

0908 Equal Cross, Female BSPP Thread

Nickel-plated brass

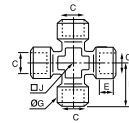

C			E	G	H	J	Kg
G1/8	0908 00 10		8	13	21	10	0.038
G1/4	0908 00 13		11	17	25.5	13	0.074
G3/8	0908 00 17		11.5	21	28	17	0.109
G1/2	0908 00 21		14	26	33.5	21	0.186

0909 Equal Cross, Male BSPT/Female BSPP Thread

Nickel-plated brass

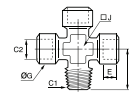

C1	C2		E	G	H	J	Kg
R1/8	G1/8	0909 00 10	8	13	18.5	10	0.034
R1/4	G1/4	0909 00 13	11	17	23.5	13	0.069
R3/8	G3/8	0909 00 17	11.5	21	26	17	0.098
R1/2	G1/2	0909 00 21	14	26	31	21	0.168

0178 Reducer, Male/Female BSPP and Metric Thread

Nickel-plated brass, NBR

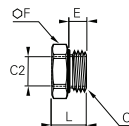

C1	C2		E	F	L	Kg
M7x1	M5x0.8	0178 55 19	5	10	12	0.005
G1/8	M5x0.8	0178 10 19	5	13	9	0.005
G1/4	G1/8	0178 13 10	5.5	16	9.5	0.006
G3/8	G1/8	0178 17 10	5.5	20	10.5	0.016
G3/8	G1/4	0178 17 13	5.5	20	10.5	0.011
G1/2	G1/4	0178 21 13	7.5	24	12.5	0.024
G1/2	G3/8	0178 21 17	7.5	24	12.5	0.016
G3/4	G1/2	0178 27 21	7.5	32	13.5	0.035

With integrated O-ring seal

0903 Reducer, Male/Female BSPP Thread

Nickel-plated brass

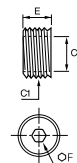

C1	C2		E	F	Kg
G1/4	G1/8	0903 10 13	8	6	0.004
G3/8	G1/4	0903 13 17	9	8	0.007
G1/2	G3/8	0903 17 21	10	10	0.011
G3/4	G1/2	0903 21 27	14	12	0.023
G1	G3/4	0903 27 34	20	17	0.038

Nickel-Plated Brass Adaptors

0904 Reducer, Male BSPT/Female BSPP Thread

Nickel-plated brass



C1	C2		F	L	Kg
R1/4	G1/8	0904 10 13	14	16	0.010
R3/8	G1/8	0904 10 17	17	16.5	0.020
R1/2	G1/8	0904 10 21	22	19.5	0.035
R3/8	G1/4	0904 13 17	17	16.5	0.015
R1/2	G1/4	0904 13 21	22	19.5	0.031
R1/2	G3/8	0904 17 21	22	19.5	0.024
R3/4	G3/8	0904 17 27	27	23	0.056
R3/4	G1/2	0904 21 27	27	23	0.045
R1	G1/2	0904 21 34	34	27	0.101
R1	G3/4	0904 27 34	34	27	0.074

0905 Reducer, Male BSPP/Female BSPP and Metric Thread

Nickel-plated brass

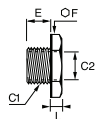

C1	C2		E	F	L	Kg
G1/8	M5x0.8	0905 19 10	6	14	4.5	0.008
G1/4	G1/8	0905 10 13	8	17	5	0.011
	G1/8	0905 10 17	9	19	5	0.019
G3/8	G1/4	0905 13 17	9	19	5	0.013
	G1/4	0905 13 21	10	24	5.5	0.031
G1/2	G3/8	0905 17 21	10	24	5.5	0.022
	G3/8	0905 17 27	11	30	6.5	0.055
G3/4	G1/2	0905 21 27	11	30	6.5	0.041

*Please contact us for detailed drawings of external thread.

0906 Increaser, Male BSPP and Metric/Female BSPP Thread

Nickel-plated brass

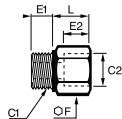

C1	C2		E1	E2	F	L	Kg
M5x0.8	G1/8	0906 10 19	4	8	14	10.5	0.010
	G1/8	0906 00 10	6	8	14	10.5	0.011
G1/8	G1/4	0906 10 13	6	11	17	13.5	0.017
	G3/8	0906 10 17	6	11.5	22	14.5	0.029
	G1/4	0906 00 13	8	11	17	13.5	0.019
G1/4	G3/8	0906 13 17	8	11.5	22	14.5	0.032
	G1/2	0906 13 21	8	14	24	18	0.037
G3/8	G3/8	0906 00 17	9	11.5	22	14.5	0.035
	G1/2	0906 17 21	9	14	24	18	0.038
G1/2	G1/2	0906 00 21	10	14	26	20	0.053

0933 Increaser, Male BSPT/Female BSPP Thread

Nickel-plated brass

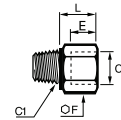

C1	C2		F	L	Kg
R1/8	G1/8	0933 00 10	14	10	0.011
R1/4	G1/4	0933 00 13	17	13.5	0.020
R3/8	G3/8	0933 00 17	22	14.5	0.037
R1/2	G1/2	0933 00 21	26	18	0.058
R1/8	G1/4	0933 10 13	17	13.5	0.017
R1/4	G3/8	0933 13 17	22	14.5	0.034
R1/4	G1/2	0933 13 21	24	18	0.038
R3/8	G1/2	0933 17 21	24	18	0.041
R1/2	G3/4	0933 21 27	32	23.5	0.080

0907 Equal Extended Adaptor, Male/Female BSPP Thread

Nickel-plated brass



C		E	F	L	Kg
G1/8	0907 00 10	6	14	16	0.015
	0907 00 10 01	6	14	36	0.030
G1/4	0907 00 13	8	17	27	0.031
	0907 00 13 01	8	17	43	0.047

0920 Bulkhead Connector, Female BSPP and Metric Thread

Nickel-plated brass

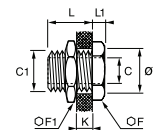

C	C1		F	F1	K max	L	L1	ØT	Kg
M5x0.8	M10x1	0920 00 19	14	14	7	10.5	3.5	10.5	0.012
G1/8	M16x1.5	0920 00 10	19	22	10	14	4	16.5	0.030
G1/4	M20x1.5	0920 00 13	24	27	16	21	4	20.5	0.057
G3/8	M26x1.5	0920 00 17	30	32	15	21	5	26.5	0.096
G1/2	M28x1.5	0920 00 21	32	36	21	27	6	28.5	0.115

Nickel-Plated Brass Adaptors

0900 Equal and Unequal Adaptor, Male BSPT Thread

Nickel-plated brass



C1	C2		F	L	Kg
R1/8	R1/8	0900 00 10	12	20.5	0.009
R1/8	R1/4	0900 10 13	14	24	0.014
	R3/8	0900 10 17	17	24.5	0.020
R1/4	R1/4	0900 00 13	14	27	0.017
	R3/8	0900 13 17	17	27.5	0.026
R3/8	R1/2	0900 13 21	22	30.5	0.046
	R3/8	0900 00 17	17	28	0.025
R1/2	R1/2	0900 17 21	22	31	0.046
	R3/4	0900 21 27	27	37	0.084
R3/4	R1	0900 27 34	34	42.5	0.145
	R1	0900 00 34	34	45.5	0.153

0901 Equal and Unequal Adaptor, Male BSPP and Metric Thread

Nickel-plated brass



C1	C2		E	E1	F	L	Kg
M5x0.8	M5x0.8	0901 00 19	4	4	8	11.5	0.002
	G1/8	0901 19 10	4	6	14	14.5	0.008
G1/8	G1/8	0901 00 10	6	6	14	16.5	0.009
	G1/4	0901 10 13	6	8	17	19	0.016
G1/4	G1/4	0901 00 13	8	8	17	21	0.019
	G3/8	0901 13 17	8	9	19	22	0.023
G3/8	G1/2	0901 13 21	8	10	24	23.5	0.036
	G3/8	0901 00 17	9	9	19	23	0.025
G1/2	G1/2	0901 17 21	9	10	24	24.5	0.038
	G1/2	0901 00 21	10	10	24	25.5	0.040

0192 Unequal Straight Adaptor, Male BSPT/BSPP Thread

Nickel-plated brass



C1	C2		E	F	L	Kg
R1/8	G1/4	0192 10 13	9.5	17	23.5	0.019
R1/4	G1/4	0192 13 13	9.5	17	27.5	0.024
R1/4	G1/2	0192 13 21	11	27	31.5	0.066
R3/8	G1/4	0192 17 13	9.5	17	28	0.025
R3/8	G1/2	0192 17 21	11	27	31.5	0.060
R1/2	G1/2	0192 21 21	11	27	34	0.061

0191 Tailpiece Adaptor for Rubber Hose, Male BSPP Thread

Nickel-plated brass

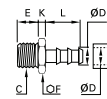

ØD	ØD1	C		E	F	K	L	Kg
4	6	G1/4	0191 04 13	9.5	17	5	22.5	0.019
	9	G1/4	0191 07 13	9.5	17	5	22.5	0.022
7	9	G1/2	0191 07 21	11	27	7	29.5	0.058
	12.2	G1/4	0191 10 13	9.5	17	5	22.5	0.020
10	12.2	G1/2	0191 10 21	11	27	7	29.5	0.060
	15.2	G1/4	0191 13 13	9.5	17	5	22.5	0.022
13	15.2	G1/2	0191 13 21	11	27	7	29.5	0.059
	16	G1/2	0191 16 21	11	27	7	36.5	0.067

0931 Tailpiece Adaptor for Rubber Hose, Male BSPP Thread

Nickel-plated brass

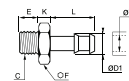

ØD	ØD1	C		E	F	K	L	Kg
6	7	G1/8	0931 06 10	6	12	4.5	19	0.009
	7	G1/4	0931 06 13	8	14	5	19	0.013
	8	G1/8	0931 07 10	6	12	4	19	0.009
7	8	G1/4	0931 07 13	8	14	5	19	0.014
	8	G3/8	0931 07 17	9	19	5	19	0.021
8	9	G1/8	0931 08 10	6	12	4	19	0.009
	9	G1/4	0931 08 13	8	14	5	19	0.014
	9	G3/8	0931 08 17	9	19	5	19	0.022
10	12	G1/4	0931 10 13	8	14	5	19	0.016
	12	G3/8	0931 10 17	9	19	5	19	0.024
15	12	G1/2	0931 10 21	10	22	6	20	0.031
	17	G3/8	0931 15 17	9	19	6	24	0.030
	17	G1/2	0931 15 21	10	22	6	24	0.036
18	20	G1/2	0931 18 21	10	22	6	24	0.040

Nickel-Plated Brass Adaptors

0934 Tailpiece Adaptor for Polymer Tubing, Male BSPT Thread

Nickel-plated brass

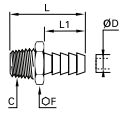

ØD	C		F	L	L1	Kg
6	R1/8	0934 06 10	12	31.5	19	0.009
	R1/4	0934 06 13	14	35	19	0.014
7	R1/8	0934 07 10	12	31.5	19	0.009
	R1/4	0934 07 13	14	35	19	0.014
8	R1/8	0934 08 10	12	31.5	19	0.010
	R1/4	0934 08 13	14	35	19	0.015
9	R1/4	0934 09 13	14	35	19	0.015
	R3/8	0934 09 17	17	35.5	19	0.021
	R1/2	0934 09 21	22	38.5	19	0.032
10	R1/8	0934 10 10	12	32.5	20	0.011
	R1/4	0934 10 13	14	36	20	0.016
	R3/8	0934 10 17	17	36.5	20	0.021
	R1/2	0934 10 21	22	39.5	20	0.033
12	R1/4	0934 12 13	14	36	20	0.016
	R3/8	0934 12 17	17	36.5	20	0.021
14	R1/2	0934 12 21	22	39.5	20	0.033
	R3/8	0934 14 17	17	38.5	22	0.025
	R1/2	0934 14 21	22	41.5	22	0.036
16	R3/8	0934 16 17	17	38.5	22	0.026
	R1/2	0934 16 21	22	41.5	22	0.037
17	R3/4	0934 16 27	27	45	22	0.055
	R1/2	0934 17 21	22	43.5	24	0.041
18	R3/8	0934 18 17	19	40.5	24	0.035
	R1/2	0934 18 21	22	43.5	24	0.044
20	R3/4	0934 18 27	27	47	24	0.064
	R1/2	0934 20 21	22	43.5	24	0.041

0902 Equal and Unequal Adaptor, Female BSPP and Metric Thread

Nickel-plated brass

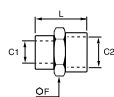

C1	C2		F	L	Kg
M5x0.8	M5x0.8	0902 00 19	8	11	0.003
	G1/8	0902 19 10	14	13.5	0.009
	G1/8	0902 00 10	14	15	0.010
G1/8	G1/4	0902 10 13	17	19	0.017
	G3/8	0902 10 17	22	20	0.028
	G1/4	0902 00 13	17	22	0.019
G1/4	G3/8	0902 13 17	22	22.5	0.031
	G1/2	0902 13 21	26	24	0.033
G3/8	G3/8	0902 00 17	22	23	0.035
	G1/2	0902 17 21	24	26	0.036
G1/2	G1/2	0902 00 21	26	28	0.049
	G3/4	0902 21 27	32	30	0.078
G3/4	G3/4	0902 00 27	32	32	0.076

0935 Tailpiece Adaptor for Polymer Tubing, Male BSPP Thread

Nickel-plated brass

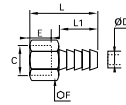

ØD	C		E	F	L	L1	Kg
6	G1/8	0935 06 10	8	12	28.5	19	0.007
8	G1/4	0935 08 13	11	15	31.5	19	0.012
12	G1/2	0935 12 21	14.5	24	36	20	0.033

0950MB Maintenance Kit, BSPP Thread

Nickel-plated brass



	H	L	L1	Kg
0950 00 00 02	81	413	330	3.500

A selection of 250 references covering the most-used products

0950M0 Maintenance Kit, BSPT Thread

Nickel-plated brass



	H	L	L1	Kg
0950 00 00 03	81	413	330	3.500

A selection of 216 references covering the most-used products

Brass Adaptors

0143 Equal Threaded Elbow, Female BSPP Thread

Brass

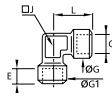

C	E	G	J	L	Kg
G1/8 0143 10 10	7.5	16.5	12	22.5	0.043
G1/4 0143 13 13	11	18.5	15	26.5	0.056
G3/8 0143 17 17	11.5	23.5	19	31.5	0.102
G1/2 0143 21 21	15	28	23	34.5	0.150
G3/4 0143 27 27	16.5	34	27	43.5	0.248

0144 Equal Stud Elbow, Male BSPT/Female BSPP Thread

Brass

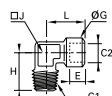

C1	C2	E	G	H	J	L	Kg
R1/8	G1/8 0144 10 10	7.5	16.5	23	12	22.5	0.036
R1/4	G1/4 0144 13 13	11	18.5	26	15	26.5	0.056
R3/8	G3/8 0144 17 17	11.5	23.5	30	19	31.5	0.086
R1/2	G1/2 0144 21 21	15	28	35	23	34.5	0.139
R3/4	G3/4 0144 27 27	16.5	34	40	27	43.5	0.227

0152 Equal Elbow, Male BSPT Thread

Brass

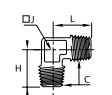

C	H	J	L	Kg
R1/8 0152 10 10	19.5	10	19.5	0.018
R1/4 0152 13 13	25	15	25	0.047
R3/8 0152 17 17	26.5	15	26.5	0.054
R1/2 0152 21 21	31.5	19	31.5	0.089
R3/4 0152 27 27	35.5	23	35.5	0.153

0145 Equal Tee, Female BSPP Thread

Brass

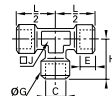

C	E	G	H	J	L/2	Kg
G1/8 0145 10 10	7.5	16.5	22.5	12	22.5	0.057
G1/4 0145 13 13	11	18.5	26.5	15	26.5	0.078
G3/8 0145 17 17	11.5	23.5	31	19	31	0.126
G1/2 0145 21 21	15	28	38	23	38	0.244
G3/4 0145 27 27	16.5	34	47.5	27	47.5	0.370

MR0434 Stud Run Tee, Female BSPP/Male BSPT Thread

Brass

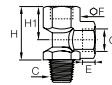

C	C1	E	F	H	H1	Kg
R1/8	G1/8 1/8MR0434B	8	14	32	15	0.029
R1/4	G1/4 1/4MR0434B	10	17	40	18	0.050
R1/2	G1/2 1/2MR0434B	14	30	63	31	0.254

0158 Stud Branch Tee, Male BSPT/Female BSPP Thread

Brass

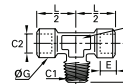

C1	C2	E	G	H	J	L/2	Kg
R1/8	G1/8 0158 10 10	7.5	16.5	21.5	12	21.5	0.048
R1/4	G1/4 0158 13 13	11	18.5	26	15	26	0.072
R3/8	G3/8 0158 17 17	11.5	23.5	30	19	30	0.120
R1/2	G1/2 0158 21 21	15	28	36	23	36	0.205
R3/4	G3/4 0158 27 27	16.5	34	44	27	44	0.310

0117 Equal Bulkhead Coupling, Female BSPP and Metric Thread

Brass

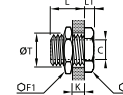

C	F	F1	K max	L	L1	ØT	ØF1	Kg
M5x0.8 0117 00 19	14	14	7	10.5	3.5	10.5	0.012	
G1/8 0117 00 10	19	22	9	14	4	16.5	0.032	
G1/4 0117 00 13	24	27	15	21	4	20.5	0.056	
G3/8 0117 00 17	30	32	14	21	5	26.5	0.096	
G1/2 0117 00 21	32	36	20	27	6	28.5	0.115	
G3/4 0117 00 27	41	41	22.5	30	6	34.5	0.161	
G1 0117 00 34	46	50	24.5	34	8	42.5	0.269	
G1 1/4 0117 00 42	55	55	29.5	39	8	49.5	0.295	
G1 1/2 0117 00 49	60	60	29.5	39	8	54.5	0.303	

Delivered with not assembled nuts

207ACBH Bulkhead Union, Female NPTF Thread

Brass

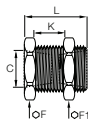

C		F	F1	K	L	Kg
NPTF1/8	207ACBH-2	78	1516	20	38	0.072
NPTF1/4	207ACBH-4	1	1.2	18	38	0.099
NPTF3/8	207ACBH-6	1.2	1.1	13	34	0.127
NPTF1/2	207ACBH-8	1.1	1.4	16	38	0.155

*F and F1 in Inch dimensions

0155 Equal Connector, Female BSPP Thread

Brass

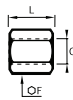
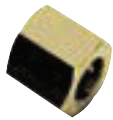

C	C1	F	L	Kg
G1/8	0155 10 10	14	17	0.014
G1/4	G1/8 0155 10 13	17	18	0.022
G1/4	0155 13 13	17	24	0.025
G3/8	0155 17 17	22	25	0.045
G1/2	0155 21 21	27	32	0.084
G3/4	0155 27 27	32	35	0.108
G1	0155 34 34	41	36	0.194

207P Equal Adaptor, Female NPTF Thread

Brass



C		F	L	Kg
NPTF1/8	207P-2	916	19	0.015
NPTF1/4	207P-4	34	28	0.041
NPTF3/8	207P-6	78	28	0.049
NPTF1/2	207P-8	1.1	38	0.089

*F in Inch dimensions

0164 Adaptor, Male NPT/Female BSPP Thread

Brass

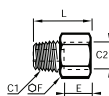

C1	C2	E	F	L	Kg
NPT1/8	G1/8 0164 11 10	7.5	14	20	0.015
NPT1/4	G1/4 0164 14 13	11	17	27.5	0.028
NPT3/8	G3/8 0164 18 17	11.5	22	28.5	0.044
NPT1/2	G1/2 0164 22 21	15	27	36.5	0.081
NPT3/4	G3/4 0164 28 27	16.5	32	38.5	0.110

Adaptor for female socket of quick-acting mould couplers

0167 Adaptor, Male BSPT/Female NPT Thread

Brass

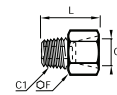

C1	C2		F	L	Kg
R1/8	NPT1/8	0167 10 11	14	21	0.016
R1/4	NPT1/4	0167 13 14	17	28.5	0.029
R3/8	NPT3/8	0167 17 18	22	29.5	0.047
R1/2	NPT1/2	0167 21 22	27	37.5	0.088
R3/4	NPT3/4	0167 27 28	32	39.5	0.119

Adaptor for female socket of quick-acting mould couplers

0168 Reducer, Male BSPP/Female BSPP and Metric Thread

Brass, technical polymer

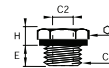

C1	C2		E	F	H	Kg
G1/8	M5x0.8	0168 10 19	7	14	6	0.009
G1/4	M5x0.8	0168 13 19	7	17	7	0.017
G1/4	G1/8	0168 13 10	7	17	7	0.011
G3/8	G1/8	0168 17 10	9	19	6	0.019
G3/8	G1/4	0168 17 13	9	19	6	0.012
G1/2	G1/8	0168 21 10	11	24	10	0.052
G1/2	G1/4	0168 21 13	11	24	10	0.042
G1/2	G3/8	0168 21 17	11	24	10	0.030
G3/4	G1/4	0168 27 13	11	32	12	0.098
G3/4	G3/8	0168 27 17	11	32	12	0.084
G3/4	G1/2	0168 27 21	11	32	12	0.063

With fitted captive seal

0163 Unequal Reducer, Male BSPT/Female BSPP Thread

Brass

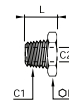

C1	C2		F	L	Kg
R1/4	G1/8	0163 13 10	14	16	0.009
R3/8	G1/8	0163 17 10	17	16.5	0.020
R3/8	G1/4	0163 17 13	17	16.5	0.012
R1/2	G1/8	0163 21 10	22	21	0.048
R1/2	G1/4	0163 21 13	22	21	0.038
R1/2	G3/8	0163 21 17	22	21	0.025
R3/4	G1/4	0163 27 13	27	24	0.085
R3/4	G3/8	0163 27 17	27	24	0.069
R3/4	G1/2	0163 27 21	27	24	0.046
R1	G3/4	0163 34 27	36	27	0.085

209P Reducer, Male/Female NPTF Thread

Brass



C	C1		F	L	Kg
NPTF1/4	NPTF1/8	209P-4-2	916	19	0.012
NPTF3/8	NPTF1/8	209P-6-2	1116	18	0.024
NPTF3/8	NPTF1/4	209P-6-4	1116	19	0.179
NPTF1/2	NPTF1/8	209P-8-2	78	25	0.059
NPTF1/2	NPTF1/4	209P-8-4	78	26	0.048
NPTF1/2	NPTF3/8	209P-8-6	78	26	0.033
NPTF3/4	NPTF1/4	209P-12-4	1.2	25	0.093
NPTF3/4	NPTF3/8	209P-12-6	1.2	26	0.080
NPTF3/4	NPTF1/2	209P-12-8	1.2	26	0.057

*F in Inch dimensions

0169 Increaser, Male/Female BSPP Thread

Brass, technical polymer



C1	C2		E1	E2	F	L	Kg
G1/8	G1/4	0169 10 13	5	11	17	16	0.019
G1/8	G3/8	0169 10 17	5	14	22	19.5	0.038
G1/4	G3/8	0169 13 17	7	14	22	19.5	0.041
G1/4	G1/2	0169 13 21	7	14.5	27	20.5	0.060
G3/8	G1/2	0169 17 21	8	14.5	27	20.5	0.062
G3/8	G3/4	0169 17 27	8	15.5	32	22	0.082
G1/2	G3/4	0169 21 27	9.5	15.5	32	22.5	0.087

With fitted captive seal

FG43 Increaser, Female BSPP/Male BSPT Thread

Brass

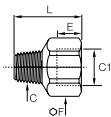

C	C1		E	F	L	Kg
R1/8	G1/4	1/4X1/8FG43B	11	17	21.5	0.019
R1/8	G3/8	3/8X1/8FG43B	12	22	25	0.035
R1/4	G3/8	3/8X1/4FG43B	12	22	28	0.040
R1/2	G3/4	3/4X1/2FG43B	16	32	39	0.107

222P Reducer, Female/Male NPTF Thread

Brass

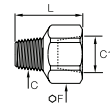

C	C1		F	L	Kg
NPTF1/8	NPTF1/4	222P-4-2	34	27	0.031
NPTF1/4	NPTF3/8	222P-6-4	78	32	0.046
NPTF3/8	NPTF1/2	222P-8-6	1116	37	0.082

*F in Inch dimensions

0121 Equal/Unequal Straight Male Adaptor, Male BSPT Thread

Brass



C1	C2		F	L	Kg
R1/8	R1/8	0121 10 10	11	19	0.009
R1/4	R1/8	0121 13 10	14	23.5	0.017
R1/4	R1/4	0121 13 13	14	27	0.020
R3/8	R1/8	0121 17 10	17	24	0.021
R3/8	R1/4	0121 17 13	17	27.5	0.026
R3/8	R3/8	0121 17 17	17	28	0.026
R1/2	R1/8	0121 21 10	22	28.5	0.041
R1/2	R1/4	0121 21 13	22	32	0.045
R1/2	R3/8	0121 21 17	22	32.5	0.045
R1/2	R1/2	0121 21 21	22	36	0.052
R3/4	R1/4	0121 27 13	27	35	0.078
R3/4	R3/8	0121 27 17	27	35.5	0.077
R3/4	R1/2	0121 27 21	27	39	0.084
R3/4	R3/4	0121 27 27	27	40	0.090
R1	R3/8	0121 34 17	36	38.5	0.127
R1	R1/2	0121 34 21	36	42	0.135
R1	R3/4	0121 34 27	36	43	0.144
R1	R1	0121 34 34	36	46	0.152
R1 1/4	R1/2	0121 42 21	46	46.5	0.219
R1 1/4	R3/4	0121 42 27	46	47.5	0.229
R1 1/4	R1	0121 42 34	46	50.5	0.234
R1 1/4	R1 1/4	0121 42 42	46	53	0.230

FF44 Equal Adaptor, Male BSPP Thread

Brass

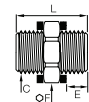

C		E	F	L	Kg
G1/8	1/8FF44B	6	14	19	0.018
G1/4	1/4FF44B	7	17	22	0.022
G3/8	3/8FF44B	8	22	24	0.040
G1/2	1/2FF44B	10	27	31	0.077

These parts are supplied with two copper seals.

0121 Equal Adaptor, Male NPT/BSPT Thread

Brass



C1	C2		F	L	Kg
NPT1/8	R1/8	0121 11 10	11	19	0.009
NPT1/4	R1/4	0121 14 13	14	27	0.021
NPT3/8	R3/8	0121 18 17	17	28	0.026
NPT1/2	R1/2	0121 22 21	22	36	0.052
NPT3/4	R3/4	0121 28 27	27	40	0.089

216P Equal Adaptor, Male NPTF Thread

Brass



C		F	L	Kg
NPTF1/8	216P-2	716	25	0.011
NPTF1/4	216P-4	916	35	0.025
NPTF3/8	216P-6	1116	36	0.035
NPTF1/2	216P-8	78	46	0.065

*F in Inch dimensions

0929 Equal 3-Piece Adaptor, Male BSPT Thread without seal

Brass

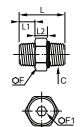

C		F	F1	L	L1	L2	Kg
R1/8	0929 00 10	15	5	27	9	8.5	0.017
R1/4	0929 00 13	19	6	33.5	11.5	9.5	0.035
R3/8	0929 00 17	22	8	36.5	13	10	0.055
R1/2	0929 00 21	27	12	45	15.5	12	0.088

This connection accessory makes assembly much easier thanks to its 3-piece design. To join 2 threaded components, simply push together and tighten the sleeve nut, thus reducing installation time.

Maximum working pressure: 50 bar.
Working temperature: -10° to +80°C.

0929..1 Equal 3-Piece Adaptor, Male BSPT Thread with seal

Brass, NBR

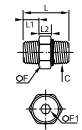

C		F	F1	L	L1	L2	Kg
R1/8	0929 01 10	15	5	27	7.5	8.5	0.017
R1/4	0929 01 13	19	6	33.5	11	9.5	0.035
R3/8	0929 01 17	22	8	36.5	11.5	10	0.055
R1/2	0929 01 21	27	12	45	14	12	0.088
R3/4	0929 01 27	36	14	52.5	16.5	17	0.199
R1	0929 01 34	46	19	63.5	19	20	0.369

This connection accessory makes assembly much easier thanks to its 3-piece design. To join 2 threaded components, simply push together and tighten the sleeve nut, thus reducing installation time.

Maximum working pressure: 50 bar.
Working temperature: -10° to +80°C. Supplied with seal

0123 Tailpiece Adaptor for Rubber Hose, Male BSPT Thread

Brass

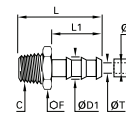

ØD	ØD1	C		F	L	L1	ØT	Kg
4	6	R1/8	0123 04 10	10	34	22.5	3.3	0.008
6	8	R1/8	0123 06 10	10	34	22.5	5	0.009
	9	R1/8	0123 07 10	10	34	22.5	5	0.009
7	9	R1/4	0123 07 13	14	38.5	22.5	6	0.018
	9	R3/8	0123 07 17	17	39	22.5	6	0.024
	12.2	R1/8	0123 10 10	13	34	22.5	5	0.014
10	12.2	R1/4	0123 10 13	14	38.5	22.5	7	0.020
	12.2	R3/8	0123 10 17	17	39	22.5	9.5	0.023
12	14	R3/8	0123 12 17	17	46	29.5	11	0.026
	15	R1/4	0123 13 13	17	45.5	29.5	7	0.027
13	15	R3/8	0123 13 17	17	46	29.5	11	0.026
	15	R1/2	0123 13 21	22	50.5	29.5	12	0.045
	18.5	R3/8	0123 16 17	19	54.5	38	11	0.039
16	18.5	R1/2	0123 16 21	22	59	38	14	0.053
	18.5	R3/4	0123 16 27	27	62	38	15	0.084
	21.5	R3/8	0123 19 17	22	54.5	38	11	0.047
19	21.5	R1/2	0123 19 21	22	59	38	14	0.057
	21.5	R3/4	0123 19 27	27	62	38	18	0.083
	26.7	R3/4	0123 25 27	27	62	38	18	0.078
25	27	R1	0123 25 34	36	65	38	24	0.124
32	34.5	R1	0123 32 34	36	70	43	24	0.144

0136 Tailpiece Adaptor for Flexible Tubing, Male BSPT Thread

Brass

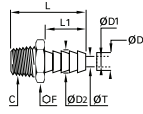

ØD	ØD1	ØD2	C		F	L	L1	ØT	Kg
6	4	4.3	R1/8	0136 06 10	10	26.5	15	2	0.006
	4	4.3	R1/4	0136 06 13	14	31	15	2	0.015
	4	4.3	R3/8	0136 06 17	17	31.5	15	2	0.020
8	6	6.4	R1/8	0136 08 10	10	26.5	15	4	0.007
	6	6.4	R1/4	0136 08 13	14	31	15	4	0.015
	6	6.4	R3/8	0136 08 17	17	31.5	15	4	0.020
10	8	8.4	R1/4	0136 10 13	14	31	15	6	0.016
	8	8.4	R3/8	0136 10 17	17	31.5	15	6	0.020
	8	8.4	R1/2	0136 10 21	22	36	15	6	0.039
12	10	10.7	R1/4	0136 12 13	14	36	20	7	0.018
	10	10.7	R3/8	0136 12 17	17	36.5	20	8	0.022
	10	10.7	R1/2	0136 12 21	22	41	20	8	0.040
14	12	12.7	R1/4	0136 14 13	14	36	20	7	0.019
	12	12.7	R3/8	0136 14 17	17	36.5	20	10	0.023
	12	12.7	R1/2	0136 14 21	22	41	20	10	0.041
	12	12.7	R3/4	0136 14 27	27	44	20	10	0.072
16	13	13.7	R3/8	0136 16 17	17	36.5	20	11	0.023
	13	13.7	R1/2	0136 16 21	22	41	20	11	0.040
	13	13.7	R3/4	0136 16 27	27	44	20	11	0.071

Stainless Steel Adaptors

1844 Equal Stud Elbow, Male BSPT/Female BSPP Thread

Stainless steel 316L

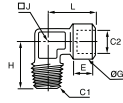

C1	C2		E	G	H	J	L	Kg
R1/8	G1/8	1844 10 10	7.5	15	20.5	10	22.5	0.022
R1/4	G1/4	1844 13 13	12	18.5	27.5	12	26.5	0.045
R3/8	G3/8	1844 17 17	12	23.5	28	14	30	0.070
R1/2	G1/2	1844 21 21	15	28	38	18	38	0.120
R3/4	G3/4	1844 27 27	16.5	33	41	22	44.5	0.160
R1	G1	1844 34 34	19	40	48	32	50	0.311

1843 Equal Elbow, Female BSPP Thread

Stainless steel 316L

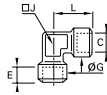

C		E	G	J	L	Kg
G1/8	1843 10 10	7.5	17.5	12	22.5	0.041
G1/4	1843 13 13	11	18.5	15	26.5	0.053
G3/8	1843 17 17	11.5	23.5	18	29	0.075
G1/2	1843 21 21	15	28	23	38	0.158
G3/4	1843 27 27	16.5	33	22	43.5	0.209
G1	1843 34 34	19	40	32	52	0.465

1845 Equal Tee, Female BSPP Thread

Stainless steel 316L

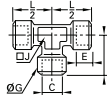

C		E	G	H	J	L/2	Kg
G1/8	1845 10 10	7.5	17.5	22.5	12	22.5	0.057
G1/4	1845 13 13	11	18.5	26.5	15	26.5	0.074
G3/8	1845 17 17	11.5	23.5	29	18	29	0.103
G1/2	1845 21 21	15	28	38	23	38	0.217
G3/4	1845 27 27	16.5	33	43.5	22	43.5	0.301
G1	1845 34 34	19	40	50	32	50	0.447

1817 Equal Bulkhead Adaptor, Female BSPP Thread

Stainless steel 316L

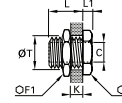

C		F	F1	K max	L	L1	ØT min	Kg
G1/8	1817 00 10	19	22	9	14	4	16.5	0.031
G1/4	1817 00 13	24	27	15	21	4	20.5	0.053
G3/8	1817 00 17	30	32	14	21	5	26.5	0.089
G1/2	1817 00 21	32	36	20	27	6	28.5	0.108
G3/4	1817 00 27	41	41	22.5	30	6	34.5	0.152
G1	1817 00 34	46	50	24.5	34	8	42.5	0.253

1871 Equal Bulkhead Adaptor, Female NPT Thread

Stainless steel 316L

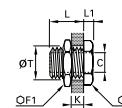

C		F	F1	K max	L	L1	ØT min	Kg
NPT1/8	1871 00 11	19	22	9	14	5	16.5	0.031
NPT1/4	1871 00 14	24	22	9	14	5	20.5	0.060
NPT3/8	1871 00 18	30	32	18	23	5	26.5	0.096
NPT1/2	1871 00 22	32	36	22	29	6	28.5	0.119

1855 Equal Connector, Female BSPP Thread

Stainless steel 316L



C		F	L	Kg
G1/8	1855 10 10	14	17	0.013
G1/4	1855 13 13	17	24	0.024
G3/8	1855 17 17	22	25	0.042
G1/2	1855 21 21	27	32	0.077
G3/4	1855 27 27	14	35	0.102
G1	1855 34 34	41	40	0.202

1870 Equal Connector, Female NPT Thread

Stainless steel 316L



C		F	L	Kg
NPT1/8	1870 11 11	14	19	0.015
NPT1/4	1870 14 14	17	28	0.029
NPT3/8	1870 18 18	22	28	0.050
NPT1/2	1870 22 22	27	35	0.092

Stainless Steel Adaptors

1862 Reducer Connector, Female BSPP Thread

Stainless steel 316L

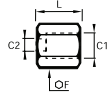

C1	C2		F	L	Kg
G1/4	G1/8	1862 13 10	17	20.5	0.024
G3/8	G1/8	1862 17 10	22	21	0.043
	G1/4	1862 17 13	22	24.5	0.048
G1/2	G1/4	1862 21 13	27	28.5	0.086
	G3/8	1862 21 17	27	29	0.081
G3/4	G1/2	1862 27 21	32	39.5	0.148
G1	G3/4	1862 34 27	41	45	0.282

1863 Reducer, Male BSPT/Female BSPP Thread

Stainless steel 316L



C1	C2		F	L	Kg
R1/4	G1/8	1863 13 10	14	16	0.008
R3/8	G1/8	1863 17 10	17	16.5	0.019
	G1/4	1863 17 13	17	16.5	0.011
R1/2	G1/4	1863 21 13	22	21	0.035
	G3/8	1863 21 17	22	21	0.023
R3/4	G1/2	1863 27 21	27	25.5	0.045
R1	G3/4	1863 34 27	36	28.5	0.084

1864 Adaptor, Male NPT/Female BSPP Thread

Stainless steel 316L

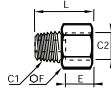

C1	C2		E	F	L	Kg
NPT1/8	G1/8	1864 11 10	7.5	14	21.5	0.015
NPT1/4	G1/4	1864 14 13	11	17	30	0.028
NPT3/8	G3/8	1864 18 17	11.5	22	31	0.044
NPT1/2	G1/2	1864 22 21	15	27	39.5	0.081

1872 Reducer, Male/Female NPT Thread

Stainless steel 316L



C1	C2		F	L	Kg
NPT1/4	NPT1/8	1872 14 11	14	16	0.010
NPT3/8	NPT1/8	1872 18 11	19	16.5	0.023
NPT3/8	NPT1/4	1872 18 14	19	16.5	0.016
NPT1/2	NPT1/4	1872 22 14	22	21	0.039
NPT1/2	NPT3/8	1872 22 18	22	21	0.027

1867 Adaptor, Male BSPT/Female NPT Thread

Stainless steel 316L

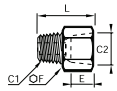

C1	C2		E	F	L	Kg
R1/8	NPT1/8	1867 10 11	8	14	21	0.015
R1/4	NPT1/4	1867 13 14	11.5	17	28.5	0.028
R3/8	NPT3/8	1867 17 18	12	22	29.5	0.045
R1/2	NPT1/2	1867 21 22	15.5	27	37.5	0.082

1861 Increaser, Male BSPT/Female BSPP Thread

Stainless steel 316L

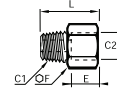

C1	C2		E	F	L	Kg
R1/8	G1/4	1861 10 13	11	17	24	0.022
R1/8	G3/8	1861 10 17	11.5	22	25	0.038
R1/4	G3/8	1861 13 17	11.5	22	28.5	0.042
R1/4	G1/2	1861 13 21	15	27	32.5	0.069
R3/8	G1/2	1861 17 21	15	27	33	0.069
R1/2	G3/4	1861 21 27	16.5	32	38	0.093
R3/4	G1	1861 27 34	19	41	43.5	0.181

Stainless Steel Adaptors

1873 Increaser, Male/Female NPT Thread

Stainless steel 316L

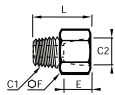

C1	C2		E	F	L	Kg
NPT1/8	NPT1/4	1873 11 14	14	17	25	0.024
	NPT3/8	1873 11 18	14	22	25	0.039
NPT1/4	NPT3/8	1873 14 18	14	22	28.5	0.043
	NPT1/2	1873 14 22	17.5	27	31	0.066
NPT3/8	NPT1/2	1873 18 22	17.5	27	31.5	0.066

1821 Equal and Unequal Adaptor, Male BSPT Thread

Stainless steel 316L



C1	C2		F	L	Kg
R1/8	R1/8	1821 10 10	12	19	0.009
R1/4	R1/8	1821 13 10	14	23.5	0.015
	R1/4	1821 13 13	14	27	0.019
R3/8	R1/4	1821 17 13	17	27.5	0.023
	R3/8	1821 17 17	17	28	0.024
R1/2	R3/8	1821 21 17	22	32.5	0.042
	R1/2	1821 21 21	22	36	0.049
R3/4	R1/2	1821 27 21	27	41	0.079
	R3/4	1821 27 27	27	42	0.088
R1	R3/4	1821 34 27	36	46	0.141
	R1	1821 34 34	36	48	0.147

1821 Equal Adaptor, Male NPT Thread

Stainless steel 316L



C		F	L	Kg
NPT1/8	1821 11 11	12	23	0.011
NPT1/4	1821 14 14	14	32	0.023
NPT3/8	1821 18 18	19	33	0.031
NPT1/2	1821 22 22	22	42	0.056
NPT3/4	1821 28 28	27	40	0.083

1823 Tailpipe Adaptor for Rubber Hose, Male BSPT Thread

Stainless steel 316L

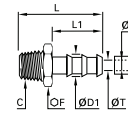

ØD	ØD1	C		F	L	L1	ØT	Kg
7	9	R1/8	1823 07 10	10	34	22.5	5	0.009
	9	R1/4	1823 07 13	14	38.5	22.5	6	0.017
10	12.2	R1/4	1823 10 13	14	38.5	22.5	7	0.018
	12.2	R3/8	1823 10 17	17	39	22.5	9.5	0.021
13	15	R3/8	1823 13 17	17	46	29.5	11	0.025
16	18.5	R1/2	1823 16 21	22	59	38	14	0.048

1823 Tailpipe Adaptor for Rubber Hose, Male NPT Thread

Stainless steel 316L

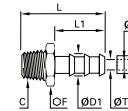

ØD	ØD1	C		F	L	L1	ØT	Kg
1/4	8.3	NPT1/8	1823 56 11	12	34	22.5	5.3	0.010
	8.3	NPT1/4	1823 56 14	14	38.5	22.5	5.3	0.016
3/8	11.7	NPT1/4	1823 60 14	14	38.5	22.5	8.5	0.018
	11.7	NPT3/8	1823 60 18	19	39	22.5	8.5	0.026

Brass & Anodised Aluminium Manifolds

0135 Manifold Block, Female BSPP Thread

Brass

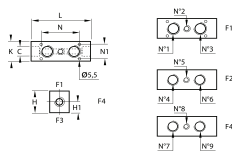

C		H	H1	K	L	N	Kg
G1/4	0135 06 13	30	13	25	70	37	0.335
G1/4	0135 09 13	30	13	25	87	54	0.409
G1/2	0135 06 21	40	16	35	86	45	0.714
G1/2	0135 09 21	40	16	35	109	68	0.900
G3/4	0135 10 27	45	21	40	122	78	1.232

This product is designed to distribute in several directions.

3311 Manifold, Female BSPP and Metric Thread

Treated aluminium

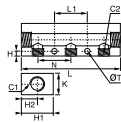

C1	C2		Number of Outlets	H	H1	H2	K	L	L1	N	ØT	Kg
G1/8	M5x0.8	3311 19 10 07	7	3.5	20	8.5	15	95	80	11	4.4	0.057
	G1/8	3311 10 13 02	2	4.5	30	15	20	61	50	30	5	0.075
	G1/8	3311 10 13 03	3	4.5	30	15	20	91	30	30	5	0.112
G1/4	G1/8	3311 10 13 04	4	4.5	30	15	20	121	60	30	5	0.165
	G1/8	3311 10 13 05	5	4.5	30	15	20	151	90	30	5	0.209
	G1/8	3311 10 13 06	6	4.5	30	15	20	181	120	30	5	0.244
	G1/4	3311 13 17 02	2	5.5	30	11	20	74	61	36	6.5	0.076
	G1/4	3311 13 17 03	3	6	30	11	20	110	36	36	6.5	0.121
G3/8	G1/4	3311 13 17 04	4	6	30	11	20	146	72	36	6.5	0.147
	G1/4	3311 13 17 05	5	6	30	11	20	182	108	36	6.5	0.212
	G1/4	3311 13 17 06	6	6	30	11	20	218	144	36	6.5	0.220

3312 Cross Manifold, Female BSPP and Metric Thread

Treated aluminium

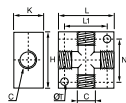

C		H	K	L	L1	N	ØT	Kg
M5x0.8	3312 00 19	20	10	20	12	12	4.5	0.008
G1/8	3312 00 10	30	16	30	23	22	4.5	0.028
G1/4	3312 00 13	40	20	40	30	27	5.5	0.061
G3/8	3312 00 17	50	25	50	38	39	6.5	0.118
G1/2	3312 00 21	50	25	50	38	39	6.5	0.101

3313 Double Manifold, Female BSPP Thread

Treated aluminium

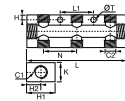

C1	C2		Number of Outlets	H	H1	H2	K	L	L1	N	ØT	Kg
	G1/8	3313 10 13 02	2x2	4.5	30	15	20	61	50	30	5	0.075
	G1/8	3313 10 13 03	2x3	4.5	30	15	20	91	30	30	5	0.115
G1/4	G1/8	3313 10 13 04	2x4	4.5	30	15	20	121	60	30	5	0.151
	G1/8	3313 10 13 05	2x5	4.5	30	15	20	151	90	30	5	0.182
	G1/4	3313 13 17 02	2x2	6	40	20	20	74	61	36	6.5	0.109
G3/8	G1/4	3313 13 17 03	2x3	6	40	20	20	110	36	36	6.5	0.179
	G1/4	3313 13 17 04	2x4	6	40	20	20	146	72	36	6.5	0.238
	G1/4	3313 13 17 05	2x5	6	40	20	20	182	108	36	6.5	0.286
	G1/4	3313 13 21 03	2x3	6	40	20	28	116	36	36	6.5	0.230
G1/2	G1/4	3313 13 21 04	2x4	6	40	20	28	152	72	36	6.5	0.298
	G1/4	3313 13 21 05	2x5	6	40	20	28	188	108	36	6.5	0.377

3301 Modular Manifold

Treated aluminium, NBR

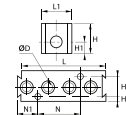

ØD		Number of Outlets	H	H1	H2	H3	L	L1	N	N1	Kg
4	3301 04 00	8	25	10	4.5	16	73.5	25	35	17	0.108
6	3301 06 00	4	25	10	4.5	16	73.5	25	35	17	0.109

Fixing with screw M3x20

3303 End Plate for Manifold

Treated aluminium

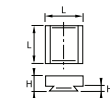

	H	H1	L	Kg
3303 00 01	9.5	3.5	25	0.014

Nickel-Plated Brass Adaptors

0222 Internal Hex Plug, Male BSPP and Metric Thread

Nickel-plated brass, NBR

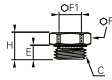

C		E	F	F1	H	Kg
M5x0.8	0222 19 00	3.5	8	2.5	7	0.002
M7x1	0222 55 00	5	10	3	8.5	0.003
G1/8	0222 10 00	5	13	5	8.5	0.006
G1/4	0222 13 00	5.5	16	6	9.5	0.010
G3/8	0222 17 00	5.5	20	8	10.5	0.019
G1/2	0222 21 00	7.5	24	10	12	0.031

With integrated O-ring seal

0936 Internal Hexagon Head Plug, Male BSPT Thread

Nickel-plated brass

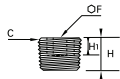

C		F	H	Kg
R1/8	0936 00 10	5	8	0.003
R1/4	0936 00 13	6	10	0.007
R3/8	0936 00 17	8	11	0.013
R1/2	0936 00 21	10	13	0.026

0919 Internal Hexagon Head Plug, Male BSPP and Metric Thread without seal

Nickel-plated brass

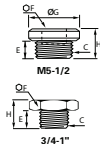

C		E	F	G	H	Kg
M5x0.8	0919 00 19	4	2.5	8	6.5	0.001
G1/8	0919 00 10	6	5	15	9.5	0.007
G1/4	0919 00 13	8	6	18	11.5	0.013
G3/8	0919 00 17	9	8	21	13	0.021
G1/2	0919 00 21	10	10	25	14.5	0.035
G3/4	0919 00 27	11	14	31	15.5	0.049
G1	0919 00 34	13	17	38	17.5	0.072

0919..1 Internal Hexagon Head Plug, Male BSPP and Metric Thread with seal

Nickel-plated brass

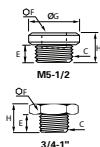

C		E	F	G	H	Kg
G1/8	0919 01 10	6.5	5	14	9.5	0.005
G1/4	0919 01 13	8	6	17	11.5	0.011
G3/8	0919 01 17	9	8	20	12.5	0.018
M5X0.8	0919 01 19	4.5	2.5	8	7.2	0.001
G1/2	0919 01 21	10	10	26	14	0.032

0205 Internal Hexagon Head Plug, Male BSPT Thread

Brass

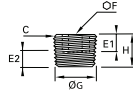

C		E1	E2 max	E2 min	F	G	H	Kg
	0205 07 00							0.002
R1/8	0205 10 00	6	4.9	3.1	5	9.7	8	0.003
R1/4	0205 13 00	8	7.3	4.7	6	13.2	10	0.007
R3/8	0205 17 00	8	7.7	5.1	8	16.7	11	0.013
R1/2	0205 21 00	8	10	6.4	10	21	13	0.026
R3/4	0205 27 00	11	11.3	7.7	14	26.5	17	0.053
R1	0205 34 00	13	12.7	8.1	17	33.2	19	0.094
R1 1/4	0205 42 00	14	15	10.4	22	42	22	0.178
R1 1/2	0205 49 00	14	15	10.4	24	47.8	22	0.243
R2	0205 48 00	16	18.2	13.6	30	59.6	25	0.435

For BSPT plug from 1/2" - 1 1/2" inclusive:
Conforms to DIN 906.
Thread: EN 10226-0

0205 Internal Hexagon Head Plug, Male NPT Thread

Brass

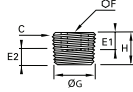

C		E1	E2 max	E2 min	F	G	H	Kg
NPT1/8	0205 11 00	6	5	3.2	5	10.2	8	0.004
NPT1/4	0205 14 00	8	7.2	4.4	6	13.6	10	0.008
NPT3/8	0205 18 00	8	7.5	4.7	8	17	11	0.014
NPT1/2	0205 22 00	8	9.9	6.3	10	21.2	13	0.026
NPT3/4	0205 28 00	11	10.4	6.8	14	26.6	17	0.053
NPT1	0205 35 00	13	12.4	8	17	33.2	19	0.091

219P Hexagon Head Plug, Male NPTF Thread

Brass



C		F	H	Kg
NPTF1/8	219P-2	316	8	0.004

*F in Inch dimensions

0209 Square Head Plug, Male BSPT Thread

Brass

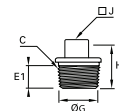

C		E1	E2 max	E2 min	G	H	J	Kg
R1/8	0209 10 00	6	4.9	3.1	9.7	16	6	0.009
R1/4	0209 13 00	8	7.3	4.7	13.2	18	8	0.015
R3/8	0209 17 00	10	7.7	5.1	16.7	20	10	0.025
R1/2	0209 21 00	11	10	6.4	21	22	13	0.047
R3/4	0209 27 00	15	11.3	7.7	26.4	28	17	0.097

Conforms to DIN 906.
Thread: EN 10226-1

0200 Hex Head Plug, Male BSPP and Metric Thread

Brass

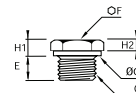

C		E	F	G	H1	H2	Kg
M6x1	0200 52 00	6	10	10	4	3.5	0.004
M8x1.25	0200 57 00	7	13	13	4	3.5	0.007
M10x1	0200 60 00	8	14	14	5	4.5	0.011
M12x1	0200 65 00	9	17	17	5	4.5	0.017
M12x1.25	0200 66 00	9	17	17	5	4.5	0.018
G1/8	0200 10 00	7	14	13.7	5.5	4	0.011
G1/4	0200 13 00	8.5	17	16.7	5.5	4	0.019

0201 Hex Head Plug with Collar, Male BSPP and Metric Thread

Brass

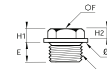

C		E	F	G	H1	H2	Kg
M16x1.5	0201 75 00	10	17	22	6.5	5	0.025
M18x1.5	0201 78 00	10	17	24	7	5	0.026
M20x1.5	0201 80 00	10	17	26	7.5	5	0.031
M22x1.5	0201 82 00	10	22	30	7.5	5	0.044
M24x1.5	0201 83 00	10	22	32	7.5	5	0.048
M24x2	0201 92 00	10	22	32	7.5	5	0.046
M30x2	0201 88 00	11	27	38	8.5	6	0.075
G3/8	0201 17 00	10	17	21.7	6.5	4.5	0.024
G1/2	0201 21 00	10	22	26.7	7.5	5	0.040
G3/4	0201 27 00	11	22	31.7	8.5	6	0.058
G1	0201 34 00	11	27	39.7	8.5	6	0.087
G1 1/4	0201 42 00	12	30	49.7	10	7	0.141

HP3 Hexagon Head Plug, Male BSPT Thread

Brass



C		F	H	Kg
R1/8	1/8HP3B	10	12	0.007
R1/4	1/4HP3B	14	16	0.018
R3/8	3/8HP3B	17	17	0.029
R1/2	1/2HP3B	22	21	0.060
R3/4	3/4HP3B	27	24	0.109
R1	1HP3B	36	27	0.196

218P Hexagon Head Plug, Male NPTF Thread, Heavy Series

Brass



C		F	H	Kg
NPTF1/8	218P-2	716	14	0.008
NPTF1/4	218P-4	916	19	0.016
NPTF3/8	218P-6	1116	20	0.033
NPTF1/2	218P-8	78	25	0.044

*F in Inch dimensions

0202 Internal Hexagon Head Plug with Collar, Male Metric Thread

Brass

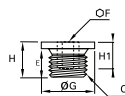

C		E	F	G	H	H1	Kg
M12x1	0202 65 00	9	6	17	11	8	0.009
M12x1.25	0202 66 00	9	6	17	11	8	0.009
M14x1.5	0202 71 00	10	6	19	13	10	0.015
M16x1.5	0202 75 00	10	8	22	13	10	0.019
M18x1.5	0202 78 00	10	10	24	13	10	0.023
M20x1.5	0202 80 00	10	12	26	13	10	0.025
M22x1.5	0202 82 00	10	12	30	13	10	0.034
M27x2	0202 86 00	11	17	35	15	11	0.052
M30x2	0202 88 00	11	19	38	15	11	0.062

Parallel metric threads, ISO standard NFE 03-054

0206 Internal Hexagon Head Plug, Male BSPT Thread

Steel

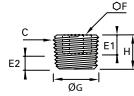

C		E1	E2 max	E2 min	F	G	H	Kg
R1/8	0206 10 00	4	3.9	2.1	5	9.7	8	0.003
R1/4	0206 13 00	5	5.8	3.2	7	13.2	10	0.007
R3/8	0206 17 00	5	5.8	3.2	8	16.7	10	0.012
R1/2	0206 21 00	5	6.8	3.2	10	21	10	0.022
R3/4	0206 27 00	6	7.8	4.2	12	26.4	12	0.048
R1	0206 34 00	6	9.3	4.7	17	33.2	12	0.085
R1 1/4	0206 42 00	11.5	9.8	5.2	22	41.9	18	0.166
R1 1/2	0206 49 00	11.5	9.8	5.2	24	47.8	20	0.222

For BSPT plugs, from 1/2" - 1 1/2" inclusive :
Conforms to DIN 906.
Thread conforms to EN 10226-1

0206 Internal Hexagon Head Plug, Male NPT Thread

Steel

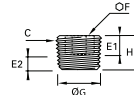

C		E1	E2 max	E2 min	F	G	H	Kg
NPT1/16	0206 08 00	6	6.4	3.8	4	7.8	7	0.002
NPT1/8	0206 11 00	6	5	3.2	5	10.2	8	0.003
NPT1/4	0206 14 00	8	7.2	4.4	6	13.6	10	0.007
NPT3/8	0206 18 00	8	7.5	4.7	8	17	11	0.012
NPT1/2	0206 22 00	8	9.9	6.3	10	21.2	13	0.023
NPT3/4	0206 28 00	11	10.4	6.8	14	26.6	17	0.048
NPT1	0206 35 00	13	12.4	8	17	33.2	19	0.082

Conforms to ANSI B1.20,1

0210 Hex Head Plug, Male BSPP and Metric Thread

Steel

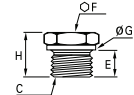

C		E	F	G	H	Kg
M8x1.25	0210 57 00	8	14	12	15	0.011
G1/8	0210 10 00	8	14	14	15	0.013
G1/4	0210 13 00	12	19	18	21	0.031
G3/8	0210 17 00	12	22	22	21	0.046
G1/2	0210 21 00	14	27	26	24	0.078
G3/4	0210 27 00	16	32	32	27	0.133
G1	0210 34 00	18	41	39	33	0.270

Profile of head undercut conforms to DIN 3852-1, form D/E.
BSPP threads, ISO 228-1.
Parallel metric threads, NFE 03-054

0216 Hex Head Plug, Male BSPT Thread

Steel

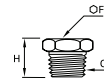

C		F	H	Kg
R1/8	0216 10 00	13	16	0.012
R1/4	0216 13 00	17	19	0.023
R3/8	0216 17 00	19	21	0.038
R1/2	0216 21 00	22	23	0.060

BSPT thread conforms to EN 10226-1

0216 Hex Head Plug, Male NPT Thread

Steel

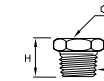

C		F	H	Kg
NPT1/8	0216 11 00	13	16	0.012
NPT1/4	0216 14 00	17	19	0.023
NPT1/2	0216 22 00	22	23	0.060

Stainless Steel Plugs

0285 Internal Hexagon Head Plug, Male BSPT Thread

Stainless steel 316L

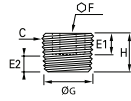

C		E1	E2 max	E2 min	F	G	H	Kg
R1/8	0285 10 00	4	3.9	2.1	5	9.7	8	0.003
R1/4	0285 13 00	5	5.8	3.2	7	13.1	10	0.007
R3/8	0285 17 00	5	5.8	3.2	8	16.7	10	0.012
R1/2	0285 21 00	5	6.8	3.2	10	21	10	0.024
R3/4	0285 27 00	6	7.8	4.2	12	26.4	12	0.051
R1	0285 34 00	6	9.3	4.7	17	33.2	12	0.089

Conforms to DIN 906
Thread: EN 10226-1

0285 Internal Hexagon Head Plug, Male NPT Thread

Stainless steel 316L

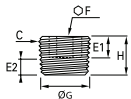

C		E1	E2 max	E2 min	F	G	H	Kg
NPT1/8	0285 11 00	6	5	3.2	5	10.2	8	0.003
NPT1/4	0285 14 00	8	7.2	4.4	6	13.6	10	0.007
NPT3/8	0285 18 00	8	7.5	4.7	8	17	11	0.013
NPT1/2	0285 22 00	8	9.9	6.3	10	21	13	0.025

Conforms to ANSI B1.20.1

0137 Bonded Seal

Zinc-plated steel with NBR seal

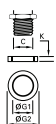

C		G1	G2	K	Kg
M12	0137 12 00	12.7	19	1.5	0.001
M14	0137 14 00	14.7	21	1.5	0.002
M16	0137 16 00	16.7	23	1.5	0.002
M18	0137 18 00	18.7	27	2	0.004
M20	0137 20 00	20.7	29	2	0.004
M22	0137 22 00	22.7	31	2	0.005
M24	0137 24 00	24.7	33	2	0.005
G1/8	0137 10 00	10.7	17	1.5	0.001
G1/4	0137 13 00	13.7	20.6	2.1	0.002
G3/8	0137 17 00	17.4	23.7	1.5	0.002
G1/2	0137 21 00	21.5	28.6	2.5	0.004
G3/4	0137 27 00	27	35.3	2	0.007
G1	0137 33 00	33.7	42	2	0.007
G1 1/4	0137 42 00	43	54	2.5	0.013
G1 1/2	0137 48 00	49	60	2.5	0.015

Note: to use these bonded seals successfully it is necessary to spot face around the female thread to provide a sealing "land".

The diameter should be 0.3 mm to 0.5 mm greater than the external diameter of the seal.

The surface finish of the thread should not exceed 12 μ .

0602 Captive Sealing Washer

Technical polymer



C		G1	G2	K	Kg
M5x0.8	0602 29 93 15	5.2	7.8	1.5	0.001
G1/8	0602 23 10 20	10.3	14	2	0.001
G1/4	0602 23 11 20	13.7	17.5	2	0.001
G3/8	0602 23 12 20	17.2	21	2	0.001
G1/2	0602 23 13 20	21.5	25.5	2.5	0.002
G3/4	0602 27 32 20	27	32	2.5	0.001
G1	0602 30 60 20	33.8	39	3	0.002

Maximum allowable working pressure: 20 bar

0139 Bi-Material Captive Sealing Washer

Zinc-plated steel with NBR seal

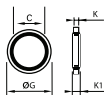

C		G	K	K1	Kg
G1/8	0139 10 00	14	1	1.7	0.001
G1/4	0139 13 00	17	1	1.7	0.001
G3/8	0139 17 00	22	1.2	2.1	0.001
G1/2	0139 21 00	26	1.6	2.5	0.002
G3/4	0139 27 00	32	1.5	2.5	0.003
G1	0139 34 00	39.6	1.7	2.6	0.003

Maximum allowable working pressure: 250 bar

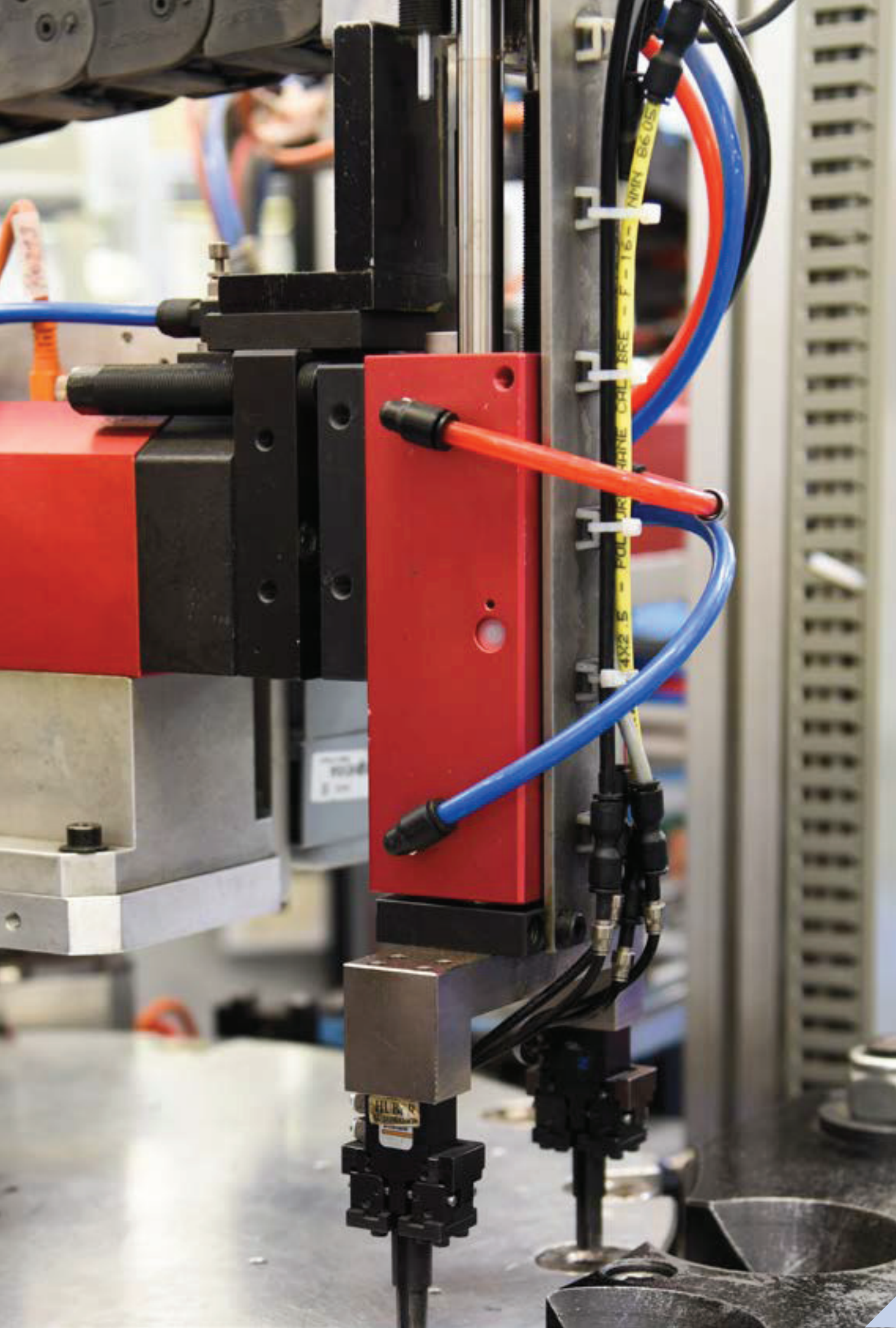

#02

COUPLINGS

Brass / Steel

Stainless Steel

Thermoplastic

Flat sealing

Safety Couplings

Coded Systems

Accessories

Mold Couplings

Water Couplings





What are your conditions of use?

COUPLING MATERIALS

Brass/Steel:

- Mainly for pneumatic applications

Stainless Steel: AISI 303 or 316L

- For aggressive media
- High corrosion resistance

Thermoplastic: POM / PVDF

- For all kind of media e.g. chemical fluids

SEAL MATERIALS*

- NBR: -20°C up to +100°C
- EPDM: -40°C up to +150°C
- FKM: -15°C up to +200°C
- FFKM: -25°C up to +240°C

* depending on the medium

Which profile interchangeability do you need?

Profile

- ISO B
- ISO C
- Euro
- ARO
- UK
- SCANDIC
- ASIA

What is your application environment?

Pressure:

System pressure, pressure peaks

Temperature:

Medium, Environment, Operation/Standstill

Medium:

Compressed air, Vacuum, Water/Seawater, Other fluids/gaseous

Flow Rate:

Volume Flow, Medium Viscosity, End connection

Operating Environment:

Ambient air quality (pollution?), risk of shocks, confined areas/access difficulties, use of products on mobile equipment, corrosive atmosphere

Which end connection do you need?

- Hose connection
- Threaded connection
- Plastic tube connection

Which function & flow control do you need?

The shut-off direction is always defined by the combination of couplings and plugs.



KF Straight-Through

- Best flow/no turbulence
- Ideal for use with liquids



KB Double Shut-off

- Shut-off valves in plug and coupling
- Pressure is maintained on both sides



KL Dry-break

- Plug and coupling have a flat valve
- Ideal to prevent drops of the medium escaping



KA Single Shut-off

- Plug is straight-through
- Flow is stopped by the valve inside the coupler during disconnection



Standard Valve
Robust and compact design



High Flow Valve
Flow is increased by up to 80% compared with traditional systems due to less turbulence



Ultra High Flow Valve
Extremely streamlined high-end valve guarantees optimal flow and can be found in our Energy Saving series

Which safety features do you need?



KS Single Shut-Off



KS Breathing Air



KD Double Shut-Off

- Safety coupling
- Safety locking mechanism prevents unintentional disconnection



KE Self-Venting Sleeve Design



KP Self-Venting Push Button

- Safety coupling with a self-venting system
- No unintentional disconnection and whiplash effect to prevent the risk of work accidents



KA Coded Systems

- Safety coupling, mechanical and colour coding
- Avoid mix-ups between media when coupling

Part Number Identification

Couplings

KA = Single Shut-Off
 KB = Double Shut-Off
 KF = Straight-Through
 KL = Dry-Break (double shut-off)
 KE = Self-Venting System
 KP = Push Button
 KS = Safety (single shut-off)
 KD = Safety (double shut-off)
 KR = Safety (straight through)

Plugs

SF = Straight-Through
 SB = Double Shut-Off
 SL = Dry-Break (double shut-off)
 SS = Safety (straight-through)
 SD = Safety (double shut-off)
 SR = Recoil Eliminator

Metric Thread

05 = M5
 10 = M10x1
 12 = M12x1,5
 14 = M14x1,5
 16 = M16x1,5
 18 = M18x1,5

Thread Sizes

10 = 1/8"
 13 = 1/4"
 17 = 3/8"
 21 = 1/2"
 26 = 3/4"
 33 = 1"

Hose Connection

03 = for 3mm LW(1/8")
 04 = for 4mm LW(5/32")
 06 = for 5mm LW(1/4")
 08 = for 8mm LW(5/16")
 09 = for 9mm LW(3/8")
 13 = for 13mm LW(1/2")
 19 = for 19mm LW(3/4")
 25 = for 25mm LW(1")

Plastic Hose

04 = for 3 x 4 mm
 05 = for 3 x 5 mm
 36 = for 3 x 6,3 mm
 06 = for 4 x 6 mm
 46 = for 4 x 6,3 mm
 08 = for 6 x 8 mm
 10 = for 8 x 10 mm
 12 = for 9 x 12 mm
 16 = for 13 x 16 mm

Seal

X = without seal
 P = Perbunan NBR
 V = FKM/FPM
 E = Ethylene-Propylene EPDM
 K = FFKM

Adding 2 Color coding for plastic

B = Blue
 G = Green
 R = Red
 Y = Yellow

Surface

X = without surface treatment
 N = Nickel plated
 C = Chrome plated
 Z = Zinc plated
 D = Durnicoated (chemic. zinc plated)
 G = Zinc plated and yellow chromated
 P = Pressure springs made of PEEK
 (only for RECTUCHEM+)

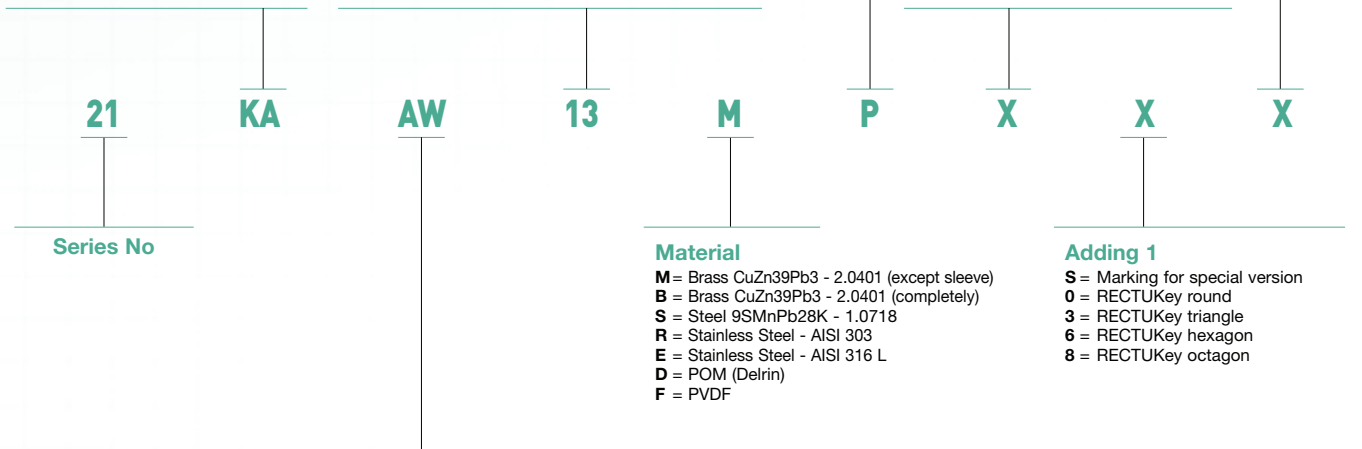

Hose Connection

TF = Hose Barb
 TH = Hose Barb 45°
 TR = Hose Barb 90°
 TP = Parker Push-Lok
 PH = Parker Push-Lok 45°
 PR = Parker Push-Lok 90°
 TS = Panel Mount with Hose Barb
 TE = Front Panel Installation, Hose Barb Panel Mount

AW = BSP parallel
 AM = Metric thread DIN 13
 AK = BSP tapered
 AN = NPT thread ANSI B 1.20.1 tapered
 AD = Metric thread DIN 2353 (ISO 8434-1)
 AR = 90° BSP tapered

Female Thread

IW = BSP parallel
 IM = Metric thread DIN 13
 IK = BSP tapered
 IN = NPSF-thread ANSI B 1.20.3
 IT = NPT thread tapered ANSI B 1.20.1

Plastic Tube Connection



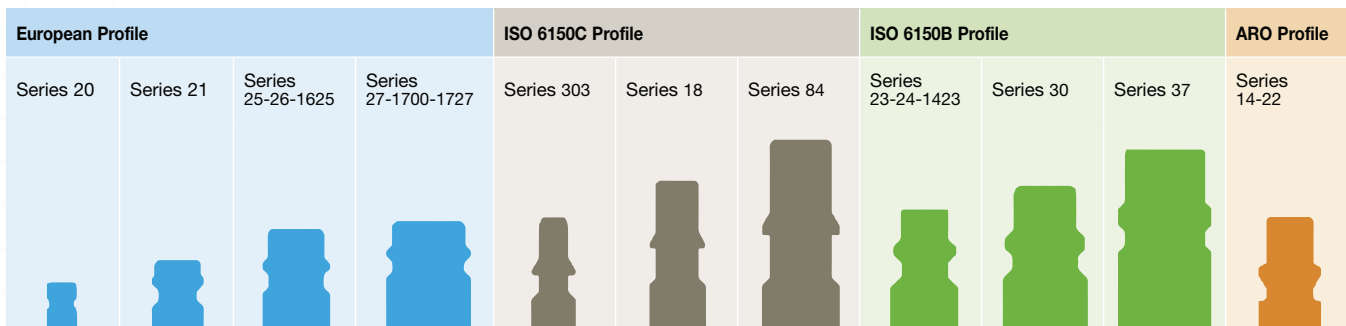

KO = with Hose Nut, without spring guard
 KS = Panel mounted, without spring guard
 KK = with spring guard

Male Thread

Common Profiles



Which series is recommended?

	Profile	DN	Series	 KF	 KA	 KB	 KL	Plugs
Brass / Steel		1,5	Series 02		P. 200			Series 02
		2	Mini Series		P. 202	P. 203		Mini Series
	German	2,5	Series 50		P. 204			Series 50
	EURO	2,7	Series 20		P. 206	P. 208		Series 20
		3	Mini Series	P. 211				Mini Series
		5	Standard Series		P. 212			Standard Series
	British	5	Series 17		P. 214			Series 17
	EURO	5	Series 21		P. 216	P. 219	P. 222	Series 21
	ARO	5,5	Series 14		P. 225			Series 22
	ISO C	5,5	Series 18		P. 227			Series 18
	British	5,5	Series 19		P. 229			Series 19
	ARO	5,5	Series 22		P. 231			Series 22
	ISO B	5,5	Series 24		P. 233			Series 23
	ISO B	5,5	Series 23		P. 235			Series 23
	ISO B	5,5	Series 1400		P. 237			Series 23
	German	6	Series 52		P. 239	P. 239		Series 52
	EURO	7,2	Series 26		P. 241	P. 243		Series 25/26
	Japanese	7,5	Series 13		P. 245			Series 13
	EURO	7,8	Series 25		P. 247	P. 249		Series 25
	EURO	7,8	Series 1600		P. 251			Series 25
	EURO	7,8	Series 1625		P. 253			Series 25
	Scandinavian	8	Series 33		P. 255			Series 33
	ISO B	8,5	Series 30		P. 257			Series 30
	ARO	9	Series 40		P. 259			Series 40
	EURO	10	Series 27		P. 260	P. 261		Series 27
	EURO	10	Series 1700		P. 263			Series 27
	EURO	10	Series 1727		P. 265			Series 27
	Scandinavian	10	Series 34		P. 267			Series 34
	various	10	Series 41	P. 269				Series 41
	ISO B	11	Series 37		P. 271			Series 37
German	12	Series 57		P. 273	P. 273		Series 57	
American	15	Series 38		P. 275	P. 275		Series 38	
American	19	Series 39		P. 277	P. 277	P. 278	Series 39	
ISO 7241-1 B	4,3-20	Series 70			P. 280		Series 70	
Stainless Steel	EURO	2,7	Series 20		P. 281	P. 282		Series 20
	ISO C	3	Series 303			P. 284		Series 303
	EURO	5	Series 21		P. 286	P. 288		Series 21
	EURO	7,4	Series 25		P. 290	P. 291		Series 25
	EURO	10	Series 27		P. 293	P. 294		Series 27
	ISO 7241-1 B	4,3-20	Series 70			P. 296		Series 70

		Profile	DN	Series	 KF	 KA	 KB	 KL	Plugs
Thermo-plastic			5	Series 21		P. 297	P. 297		Series 21
			7	Series 48		P. 303	P. 303		Series 48
			4,3-20	Series 70			P. 307		Series 70
				Components					
Flat sealing			4-9	Series 200KL				P. 309	Series 200
			3-12	Series 200KLEK				P. 311	Series 200KLEK
Safety	Standard		5	Series 21KS		P. 313	P. 314		Series 21
			7,8	Series 25KS		P. 316	P. 317		Series 25
	Breathing Air		7,4	Series 95KS		P. 318			Series 95
			7,4	Series 96KS		P. 320			Series 96
	Self-Venting with Push Button Technology	ISO 6150 C	5,5	Series 18KP		P. 322			Series 18
		ISO 6150 B	5,5	Series 24KP		P. 324			Series 23
		EURO	7,4	Series 26KP		P. 326			Series 25
		ISO 6150 B	8	Series 30KP		P. 328			Series 30
		ISO 6150 C	8	Series 84KP		P. 330			Series 84
	Self-Venting with Sleeve Technology	ARO	5,5	Series 14KE		P. 332			Series 22
		ISO B	5,5	Series 1400KE		P. 334			Series 23
		ISO B	5,5	Series 24KE		P. 336			Series 23
		EURO	7,4	Series 26KE		P. 338			Series 25
		EURO	7,8	Series 1600KE		P. 340			Series 25
		EURO	10	Series 1700KE		P. 342			Series 27
				C 9000		P. 344			C 9000
Coded Systems			5	Series 21		P. 349	P. 350		Series 21
			7,8	Series 25		P. 352	P. 354		Series 25
Accessories		Components							
Mold		International	6 / 9 / 13	Series 86 / 87 / 88	P. 358	P. 360	P. 360		Series 86/87/88
		International	6 / 9	Series 86 / 87 Safe Lock Technology	P. 363	P. 364	P. 364		Series 86/87/88
		European	6 / 9 / 13	Series 10 / 11 / 12	P. 365	P. 367	P. 367		Series 10/11/12
		European	6 / 9	Series 10 / 11 Safe Lock Technology	P. 370	P. 371	P. 371		Series 10/11/12
		European	6 / 9	Series 10 / 11 Safety Locking Technology	P. 372	P. 373	P. 373		Series 10/11/12
		French	8	Series 608	P. 375				Series 608
		Multi-Matic	8,1	Series 93	P. 377			P. 377	Series 93
		Accessories		Components					
		Hoses							
Water			12	Midi Series	P. 381	P. 381			Midi Series
			19	Maxi Series	P. 384				Maxi Series

Our performance range at a glance



Flow rate air

Using this flow rate diagram, you can identify, at a glance, the coupling series suited to your application and the corresponding operating pressure.

Many of the series listed below are also available as a straight-through KF version.

- Flow KA (l/min.) – single shut-off coupling systems
- Particularly suitable for pneumatic applications
- Flow KB (l/min.) – double shut-off coupling systems
- Particularly suitable for fluid handling applications
- Flow KE/KP (l/min.) – self-venting systems
- Particularly suitable for pneumatic applications



The details refer to the air flow rate in litres/minute.

Measurement data generated in accordance with ISO 6358;
CCTOP RP50P at input pressure 6 bar, pressure drop 0.5 bar / *pressure drop 0.6 bar

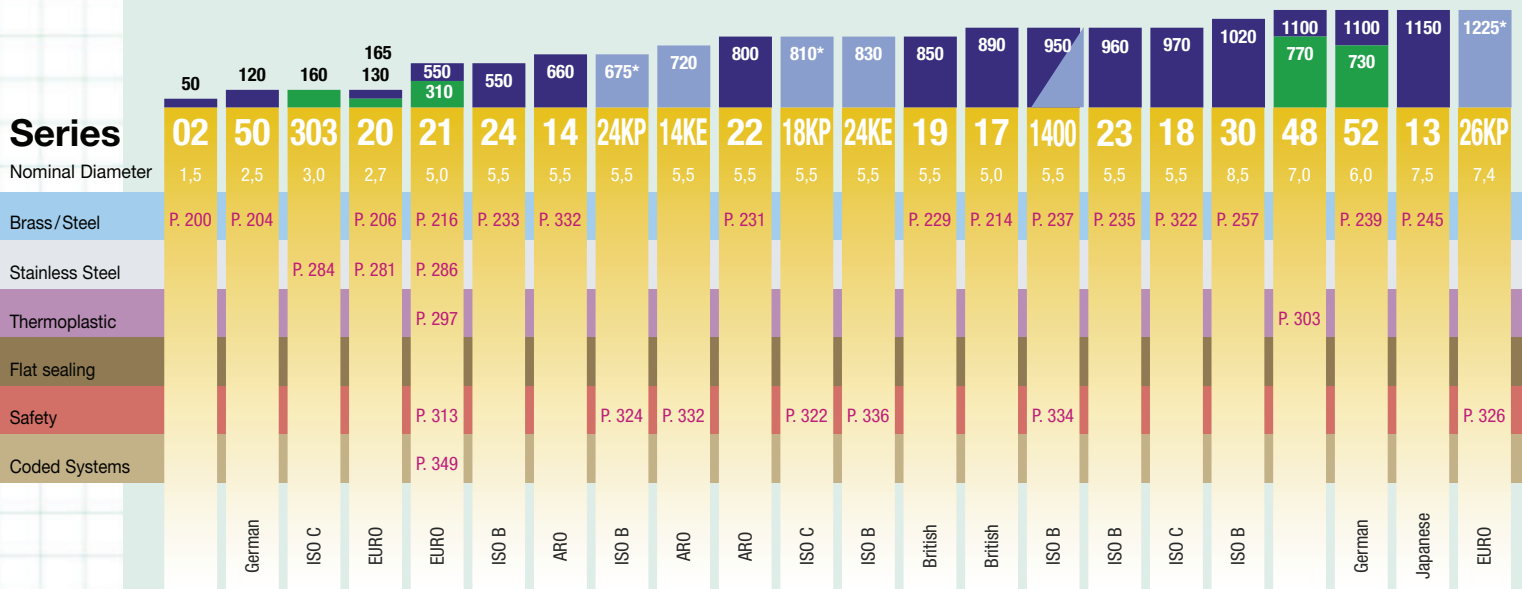

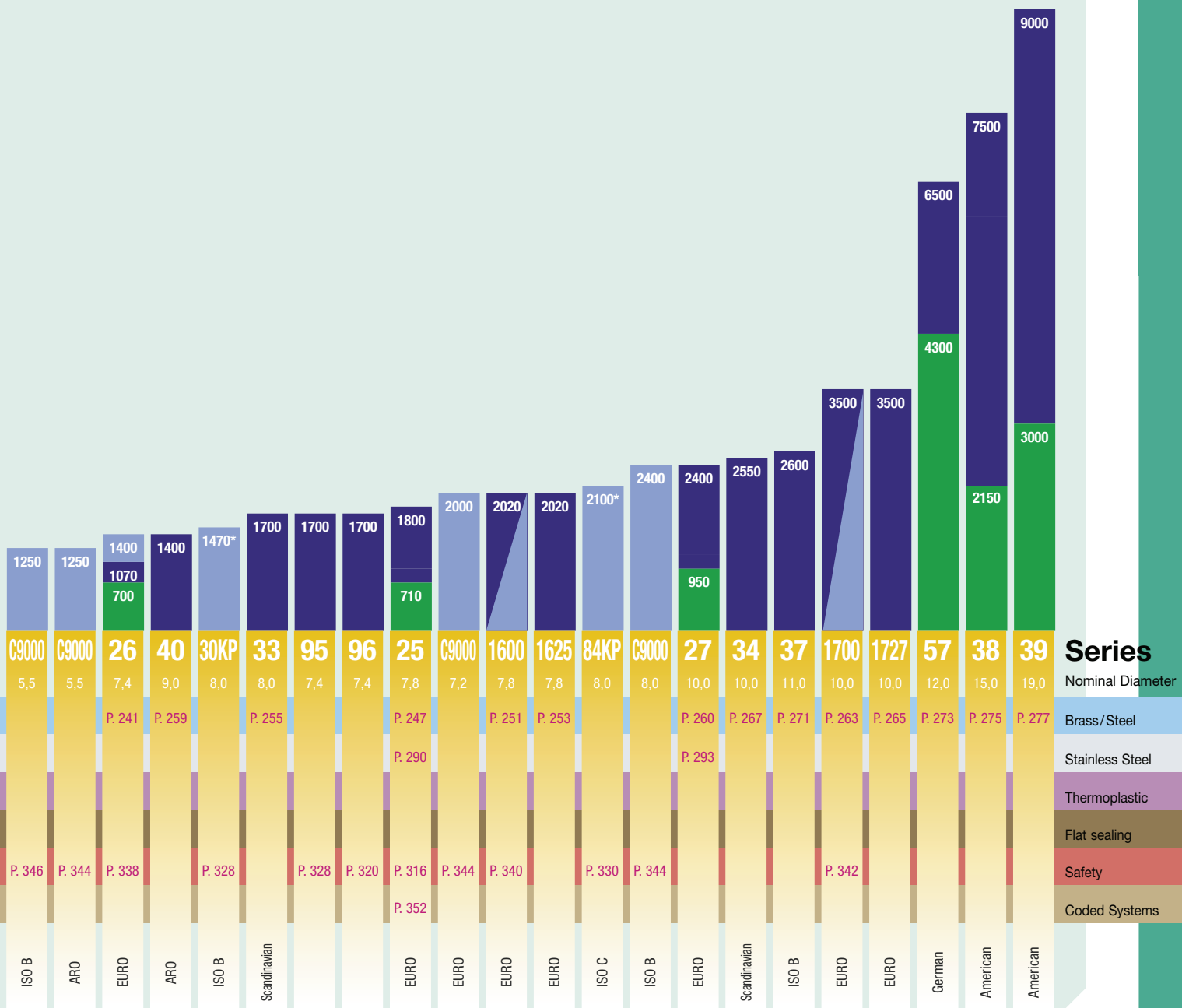

Our performance range at a glance



Flow rate water

Using this flow rate diagram, you can identify, at a glance, the coupling series suited to your application and the corresponding operating pressure.

Many of the series listed below are also available as a straight-through KF version.

- Flow KF (l/min.) – straight-through coupling systems
- Particularly suitable for pneumatic and fluid handling applications
- Flow KA (l/min.) – single shut-off coupling systems
- Particularly suitable for pneumatic applications
- Flow KB (l/min.) – double shut-off coupling systems
- Particularly suitable for fluid handling applications
- Flow KL (l/min.) – leak-free coupling systems
- Particularly suitable for fluid handling applications

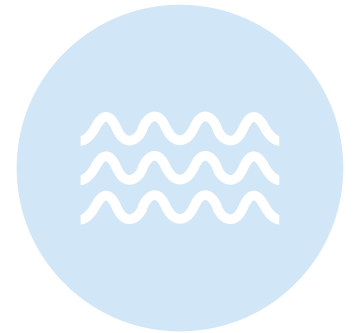

The details refer to the water flow rate in litres/minute.

Measurement data generated in accordance with ISO 7241/2:2000, pressure drop 0.5 bar

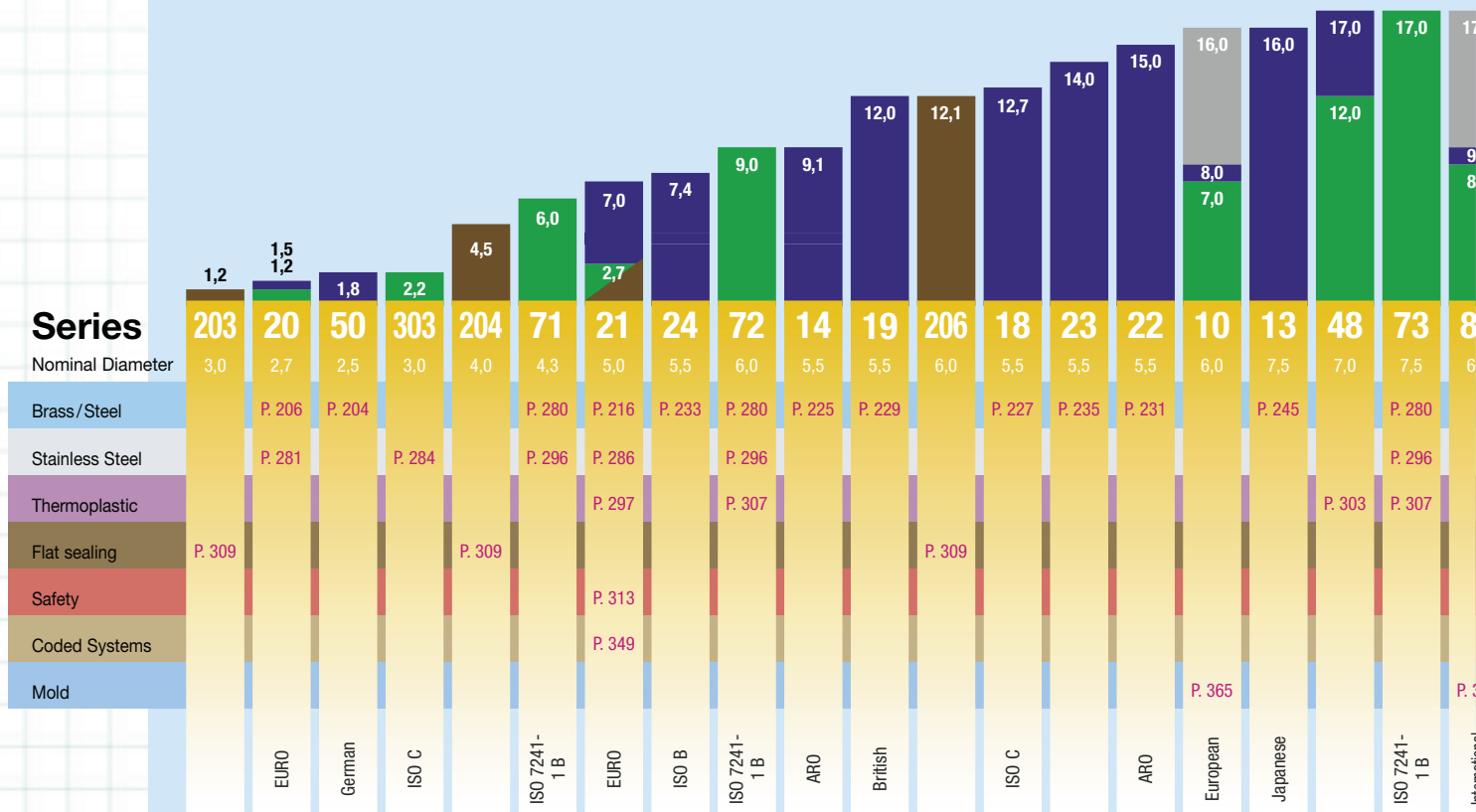

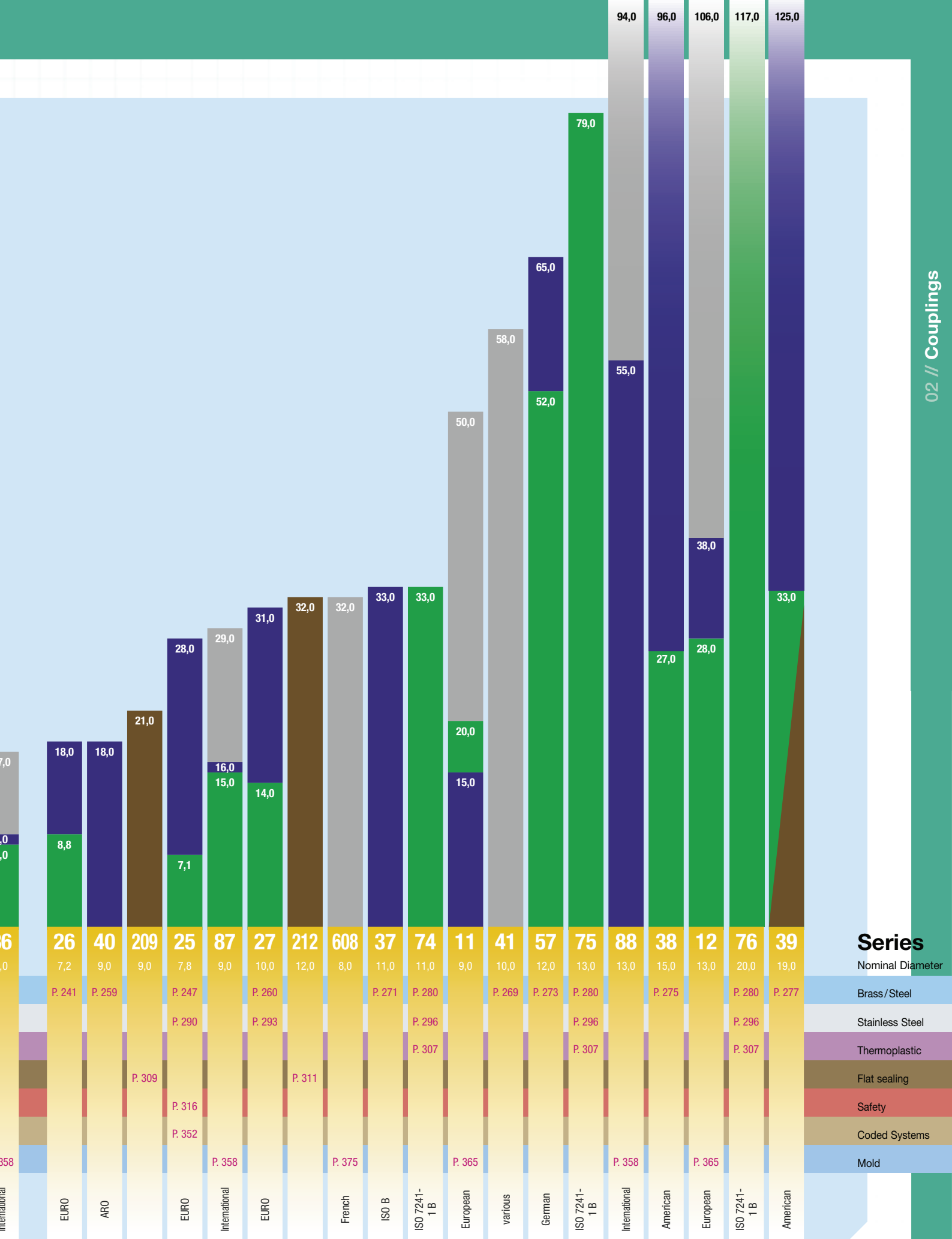

Series

- Nominal Diameter
- Brass/Steel
- Stainless Steel
- Thermoplastic
- Flat sealing
- Safety
- Coded Systems
- Mold

Cross Reference List

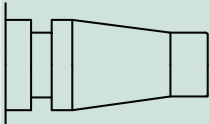
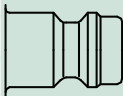
	Legris P/N	Rectus P/N*	Closest Rectus Catalogue P/N**	Page	
Series 20 Euro Profile Nominal Diameter: 2.7 	9087 20 19	20SFAM05MXN		207	
	9087 20 10	20SFAW10MXN		207	
	9086 20 19	20SFIM05MXN		207	
	9086 20 10	20SFIW10MXN		207	
	9085 20 03	20SFTF03MXN		208	
	9085 20 04	20SFTF04MXN		208	
	9085 20 05	20SFTF05MXN		208	
	9095 20 03	20SFTS03MXN		208	
	9095 20 04	20SFTS04MXN		208	
	9201 20 19	20KBAM05MPN		208	
	9201 20 10	20KBAW10MPN		208	
	9214 20 19	20KBIM05MPN		209	
	9214 20 10	20KBIW10MPN		209	
	9226 20 03	20KBTS03MPN		209	
	9226 20 04	20KBTS04MPN		209	
	9287 20 19	20SBAM05MPN		210	
	9287 20 10	20SBAW10MPN		210	
	9286 20 19	20SBIM05MPN		210	
	9286 20 10	20SBIW10MPN		210	
	9285 20 03	20SBTF03MPN		210	
	9285 20 04	20SBTF04MPN		210	
	9285 20 05	20SBTF05MPN		210	
	Series 17 British Profile Nominal Diameter: 5 	9105 17 13	17KAAK13SPN		214
		9105 17 21	17KAAK21SPN		214
		9114 17 13	17KAIW13SPN		214
9114 17 17		17KAIW17SPN		214	
9114 17 21		17KAIW21SPN		214	
9084 17 13		17SFAK13SXN		215	
9086 17 13		17SFIW13SXN		215	
Series 21 Euro Profile Nominal Diameter: 5 	9087 21 10	21SFAW10MXN		218	
	9087 21 13	21SFAW13MXN		218	
	9086 21 10	21SFIW10MXN		218	
	9086 21 13	21SFIW13MXN		218	
	9085 21 04	21SFTF04MXN		218	
	9085 21 06	21SFTF06MXN		218	
	9085 21 08	21SFTF08MXN		218	
	9095 21 04	21SFTS04MXN		219	
	9095 21 06	21SFTS06MXN		219	
	9095 21 08	21SFTS08MXN		219	
	9201 21 10	21KBAW10MPN		219	
	9201 21 13	21KBAW13MPN		219	
	9214 21 10	21KBIW10MPN		219	
	9214 21 13	21KBIW13MPN		219	
	9223 21 04	21KBTF04MPN		220	
	9223 21 06	21KBTF06MPN		220	
	9223 21 08	21KBTF08MPN		220	
	9226 21 04	21KBTS04MPN		220	
	9226 21 06	21KBTS06MPN		220	
	9226 21 08	21KBTS08MPN		220	

* Same product as Legris product

** Closest Rectus version recommended (difference may be plating, sleeve material, coating, ...)

Cross Reference List

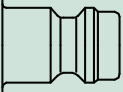
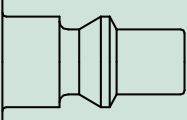
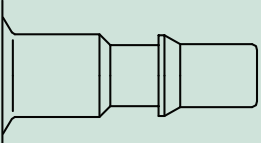
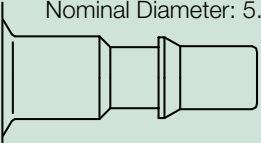
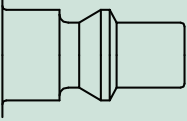
	Legris P/N	Rectus P/N*	Closest Rectus Catalogue P/N**	Page
Series 21 Euro Profile Nominal Diameter: 5 	9287 21 10	21SBAW10MPN		221
	9287 21 13	21SBAW13MPN		221
	9286 21 10	21SBIW10MPN		221
	9286 21 13	21SBIW13MPN		221
	9285 21 04	21SBTF04MPN		221
	9285 21 06	21SBTF06MPN		221
	9285 21 08	21SBTF08MPN		221
Series 14 ARO Profile Nominal Diameter: 5.5 	9101 14 13		14KAAW13MPX	225
	9101 14 17		14KAAW17MPX	225
	9101 14 21		14KAIW21MPX	225
	9114 14 13		14KAIW13MPX	225
	9114 14 17		14KAIW17MPX	225
	9114 14 21		14KAIW21MPX	225
	9123 14 06		14KATF06MPX	225
	9123 14 08		14KATF08MPX	225
	9123 14 09		14KATF09MPX	225
	9123 14 10		14KATF10MPX	225
9123 14 13		14KATF13MPX	225	
Series 18 ISO C Profile Nominal Diameter: 5.5 	9101 18 13		18KAAK13MPN	227
	9101 18 17		18KAAK17MPN	227
	9114 18 13	18KAIW13MPN		227
	9114 18 17	18KAIW17MPN		227
	9123 18 06	18KATF06MPN		227
	9123 18 08	18KATF08MPN		227
	9123 18 10	18KATF10MPN		227
	9087 18 13	18SFAW13SXX		228
	9087 18 17	18SFAW17SXX		228
	9086 18 13	18SFIW13SXX		228
	9086 18 17	18SFIW17SXX		228
	9085 18 06	18SFTF06SXX		228
	9085 18 08	18SFTF08SXX		228
	9085 18 10	18SFTF10SXX		228
Series 19 British Profile Nominal Diameter: 5.5 	9105 19 13	19KAAK13MPN		229
	9105 19 17	19KAAK17MPN		229
	9114 19 13	19KAIW13MPN		229
	9123 19 06	19KATF06MPN		229
	9084 19 13	19SFAK13SXX		230
	9085 19 10	19SFTF10SXX		230
Series 22 ARO Profile Nominal Diameter: 5.5 	9105 22 13	22KAAK13MPN		231
	9105 22 17	22KAAK17MPN		231
	9105 22 21	22KAAK21MPN		231
	9114 22 13	22KAIW13MPN		231
	9114 22 17	22KAIW17MPN		231
	9114 22 21	22KAIW21MPN		231
	9123 22 08	22KATF08MPN		231
	9123 22 10	22KATF10MPN		231
	9084 22 13	22SFAK13SXX		232
	9084 22 17	22SFAK17SXX		232

* Same product as Legris product

** Closest Rectus version recommended (difference may be plating, sleeve material, coating, ...)

Cross Reference List

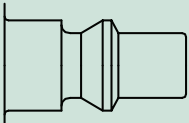
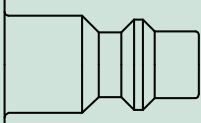
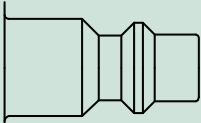
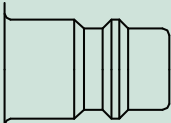
	Legris P/N	Rectus P/N*	Closest Rectus Catalogue P/N**	Page	
Series 22 ARO Profile Nominal Diameter: 5.5 	9084 22 21	22SFAK21SXN		232	
	9086 22 13	22SFIW13SXN		232	
	9086 22 17	22SFIW17SXN		232	
	9086 22 21	22SFIW21SXN		232	
	9085 22 06	22SFTF06SXN		232	
	9085 22 08	22SFTF08SXN		232	
	9085 22 09	22SFTF09SXN		232	
	9085 22 10	22SFTF10SXN		232	
	9085 22 13	22SFTF13SXN		232	
Series 24 ISO B Profile Nominal Diameter: 5.5 	9101 24 13	24KAAW13MPN		233	
	9101 24 17	24KAAW17MPN		233	
	9101 24 21	24KAAW21MPN		233	
	9114 24 13	24KAIW13MPN		233	
	9114 24 17	24KAIW17MPN		233	
	9114 24 21	24KAIW21MPN		233	
	9123 24 06	24KATF06MPN		234	
	9123 24 08	24KATF08MPN		234	
	9123 24 10	24KATF10MPN		234	
Series 23 ISO B Profile Nominal Diameter: 5.5 	9101 23 13	23KAAW13MPN		235	
	9101 23 17	23KAAW17MPN		235	
	9101 23 21		23KAAK21MPN	235	
	9114 23 13	23KAIW13MPN		235	
	9114 23 17	23KAIW17MPN		235	
	9114 23 21	23KAIW21MPN		235	
	9123 23 06	23KATF06MPN		236	
	9123 23 08	23KATF08MPN		236	
	9123 23 10	23KATF10MPN		236	
	9087 23 10	23SFAW10SXN		236	
	9087 23 13	23SFAW13SXN		236	
	9087 23 17	23SFAW17SXN		236	
	9087 23 21	23SFAW21SXN		236	
	9086 23 10	23SFIW10SXN		236	
	9086 23 13	23SFIW13SXN		236	
	9086 23 17	23SFIW17SXN		236	
	9086 23 21	23SFIW21SXN		236	
	9085 23 06	23SFTF06SXN		236	
	9085 23 08	23SFTF08SXN		236	
	9085 23 10	23SFTF10SXN		236	
	Series 26 Euro Profile Nominal Diameter: 7.2 	9101 26 10	26KAAW10MPN		241
		9101 26 13	26KAAW13MPN		241
		9101 26 17	26KAAW17MPN		241
9101 26 21		26KAAW21MPN		241	
9114 26 13		26KAIW13MPN		241	
9114 26 17		26KAIW17MPN		241	
9114 26 21		26KAIW21MPN		241	

* Same product as Legris product

** Closest Rectus version recommended (difference may be plating, sleeve material, coating, ...)

Cross Reference List

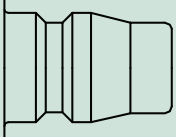
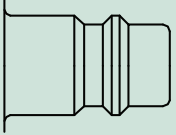
	Legris P/N	Rectus P/N*	Closest Rectus Catalogue P/N**	Page
Series 13 Japanese Profile Nominal Diameter: 7.5 	9105 13 13		13KAAK13MPX	245
	9114 13 13		13KAW13MPX	245
	9114 13 21		13KAW21MPX	245
	9123 13 13		13KATF13MPX	245
	9086 13 13	13SFIW13SXN		246
	9085 13 13	13SFTF13SXN		246
Series 25 Euro Profile Nominal Diameter: 7.8 	9087 25 10	25SFAW10SXZ		248
	9087 25 13	25SFAW13SXZ		248
	9087 25 17	25SFAW17SXZ		248
	9087 25 21	25SFAW21SXZ		248
	9086 25 10	25SFIW10SXZ		248
	9086 25 13	25SFIW13SXZ		248
	9086 25 17	25SFIW17SXZ		248
	9086 25 21	25SFIW21SXZ		248
	9085 25 06	25SFTF06SXZ		249
	9085 25 08	25SFTF08SXZ		249
	9085 25 09	25SFTF09SXZ		249
	9085 25 10	25SFTF10SXZ		249
	9085 25 13	25SFTF13SXZ		249
	9201 25 13	25KBAW13MPN		249
	9201 25 17	25KBAW17MPN		249
	9201 25 21	25KBAW21MPN		249
	9214 25 13	25KBIW13MPN		249
	9214 25 17	25KBIW17MPN		249
	9214 25 21	25KBIW21MPN		249
	9223 25 06	25KBTF06MPN		249
	9223 25 08	25KBTF08MPN		249
	9223 25 10	25KBTF10MPN		249
	9223 25 13	25KBTF13MPN		249
	9287 25 10	25SBAW10MPN		250
	9287 25 13	25SBAW13MPN		250
	9287 25 17	25SBAW17MPN		250
	9287 25 21	25SBAW21MPN		250
	9286 25 13	25SBIW13MPN		250
	9286 25 17	25SBIW17MPN		250
	9286 25 21	25SBIW21MPN		250
	9285 25 06	25SBTF06MPN		250
	9285 25 08	25SBTF08MPN		250
	9285 25 10	25SBTF10MPN		250
	9285 25 13	25SBTF13MPN		250

* Same product as Legris product

** Closest Rectus version recommended (difference may be plating, sleeve material, coating, ...)

Cross Reference List

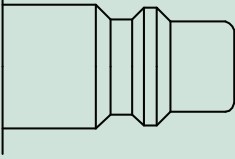
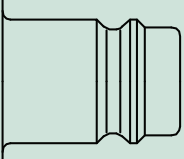
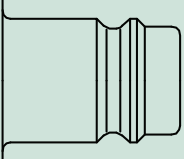
	Legris P/N	Rectus P/N*	Closest Rectus Catalogue P/N**	Page	
Series 30 ISO B Profile Nominal Diameter: 8.5 	9101 30 13		30KAAW13SPX	257	
	9101 30 17		30KAAW17SPX	257	
	9101 30 21		30KAAW21SPX	257	
	9114 30 13		30KAIW13SPX	257	
	9114 30 17		30KAIW17SPX	257	
	9114 30 21		30KAIW21SPX	257	
	9123 30 08		30KATF08SPX	257	
	9123 30 10		30KATF10SPX	257	
	9123 30 13		30KATF13SPX	257	
	9087 30 13	30SFAW13SXN		258	
	9087 30 17	30SFAW17SXN		258	
	9087 30 21	30SFAW21SXN		258	
	9086 30 13	30SFIW13SXN		258	
	9086 30 17	30SFIW17SXN		258	
	9086 30 21	30SFIW21SXN		258	
	9085 30 08	30SFTF08SXN		258	
	9085 30 10	30SFTF10SXN		258	
	9085 30 13	30SFTF13SXN		258	
	Series 27 Euro Profile Nominal Diameter: 10 	9087 27 17		27SFAK17SXN	261
		9087 27 21		27SFAK21SXN	261
9087 27 27			27SFAK26SXN	261	
9086 27 17		27SFIW17SXN		261	
9086 27 21		27SFIW21SXN		261	
9086 27 27		27SFIW26SXN		261	
9085 27 08		27SFTF08SXN		261	
9085 27 10		27SFTF10SXN		261	
9085 27 13		27SFTF13SXN		261	
9085 27 19		27SFTF19SXN		261	
9287 27 17			27SBAK17MPN	261	
9287 27 21			27SBAK21MPN	261	
9287 27 27			27SBAK26MPN	261	
9286 27 17		27SBIW17MPN		262	
9286 27 21		27SBIW21MPN		262	
9286 27 27		27SBIW26MPN		262	
9285 27 08		27SBTF08MPN		262	
9285 27 10		27SBTF10MPN		262	
9285 27 13		27SBTF13MPN		262	
9285 27 19		27SBTF19MPN		262	
Series 1700 Euro Profile Nominal Diameter: 10 	9201 27 17		27KBAK17BPN	261	
	9201 27 21		27KBAK21BPN	261	
	9201 27 27		27KBAK26BPN	261	
	9214 27 17		27KBIW17BPN	261	
	9214 27 21		27KBIW21BPN	261	
	9214 27 27		27KBIW26BPN	261	
	9223 27 08		27KBTF08BPN	261	
	9223 27 10		27KBTF10BPN	261	
	9223 27 13		27KBTF13BPN	261	
	9223 27 19		27KBTF19BPN	261	

* Same product as Legris product

** Closest Rectus version recommended (difference may be plating, sleeve material, coating, ...)

Cross Reference List

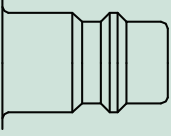
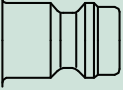
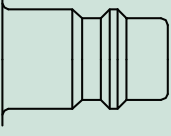
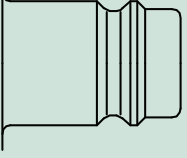
	Legris P/N	Rectus P/N*	Closest Rectus Catalogue P/N**	Page
Series 20 Euro Profile Nominal Diameter: 2.7 	9201X20 19	20KBAM05EVX		282
	9201X20 10	20KBAW10EVX		282
	9214X20 19	20KBIM05EVX		282
	9214X20 10	20KBIW10EVX		282
	9287X20 19	20SBAM05EVX		283
	9287X20 10	20SBAW10EVX		283
	9286X20 10	20SBIW10EVX		283
Series 21 Euro Profile Nominal Diameter: 5 	9087X21 10	21SFAW10EXX		287
	9087X21 13	21SFAW13EXX		287
	9086X21 10	21SFIW10EXX		287
	9086X21 13	21SFIW13EXX		287
	9201X21 10	21KBAW10EVX		288
	9201X21 13	21KBAW13EVX		288
	9214X21 10	21KBIW10EVX		288
	9214X21 13	21KBIW13EVX		288
	9287X21 10	21SBAW10EVX		288
	9287X21 13	21SBAW13EVX		288
	9286X21 10	21SBIW10EVX		288
	9286X21 13	21SBIW13EVX		288
Series 25 Euro Profile Nominal Diameter: 7.4 	9087X25 21	25SFAW21EXX		291
	9086X25 13	25SFIW13EXX		291
	9086X25 17	25SFIW17EXX		291
	9201X25 13	25KBAW13EVX		291
	9201X25 17	25KBAW17EVX		291
	9201X25 21	25KBAW21EVX		291
	9214X25 13	25KBIW13EVX		291
	9214X25 17	25KBIW17EVX		292
	9214X25 21	25KBIW21EVX		292
	9287X25 13	25SBAW13EVX		292
	9287X25 17	25SBAW17EVX		292
	9287X25 21	25SBAW21EVX		292
	9286X25 13	25SBIW13EVX		292
	9286X25 17	25SBIW17EVX		292
Series 27 Euro Profile Nominal Diameter: 10 	9087X27 21	27SFAW21EXX		294
	9087X27 27	27SFAW26EXX		294
	9086X27 17	27SFIW17EXX		294
	9201X27 17	27KBAW17EVX		294
	9201X27 21	27KBAW21EVX		294
	9201X27 27	27KBAW26EVX		294
	9214X27 17	27KBIW17EVX		294
	9214X27 21	27KBIW21EVX		294
	9214X27 27	27KBIW26EVX		294
	9287X27 17	27SBAW17EVX		295
	9287X27 21	27SBAW21EVX		295
	9287X27 27	27SBAW26EVX		295
	9286X27 17	27SBIW17EVX		295
	9286X27 21	27SBIW21EVX		295

* Same product as Legris product

** Closest Rectus version recommended (difference may be plating, sleeve material, coating, ...)



Smallest mini industrial coupling for air and gas applications. Primarily in medicine, didactics and model building. Partly suitable for liquids due to size. Coupling system with single-hand operation. Extremely small dimensions.

- Available on request:
 - in brass material without nickel plating
 - with additional end connections
 - other seals for different temperature ranges and fluids



Working Pressure*:
up to 35 bar

Material:

- Coupling: Nickel plated brass
- Plug: Nickel plated brass
- Seals: NBR

Working Temperature:
-20°C up to +100°C (NBR)

Flow Rate Air:
50 l/min.
inlet pressure 6 bar, pressure drop 0.5 bar

Flow Rate Water:
0.6 l/min.
pressure drop 0.5 bar

* maximum static working pressure with design factor 4 to 1.

Single Shut-Off

Single Shut-Off

02KAAM Coupler with valve, Male Thread

Nickel-plated brass, NBR

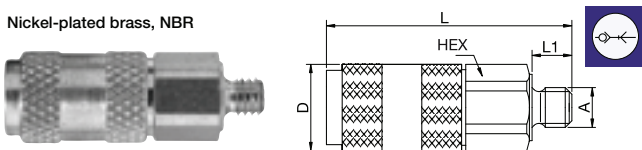

A	HEX	L	L1	D
M3 02KAAM03MPN	6	19	3	6.5

02KATF Coupler with valve, Hose Barb

Nickel-plated brass, NBR

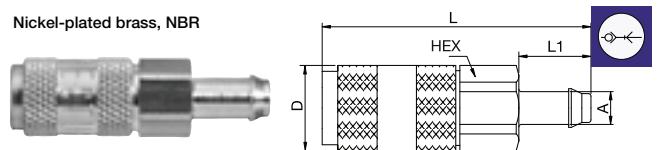

A	HEX	L	L1	D
2 02KATF02MPN	6	21	5.5	6.5
3 02KATF03MPN	6	22	5.5	6.5

02KAIM Coupler with valve, Female Thread

Nickel-plated brass, NBR

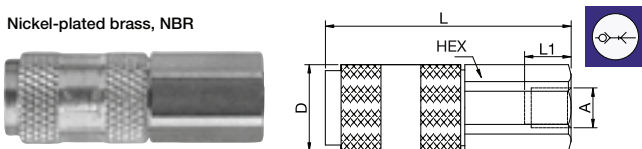

A	HEX	L	L1	D
M3 02KAIM03MPN	6	19	3	6.5

02KATS Coupler with valve, Panel Mount with Hose Barb

Nickel-plated brass, NBR

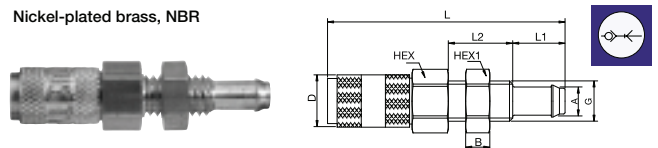

A	HEX	HEX1	B	G	L	L1	L2	D
2 02KATS02MPN	7	7	3	M5	29	5.5	8	6.5

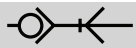

Single Shut-Off

02SFAM Plug without valve, Male Thread

Nickel-plated brass

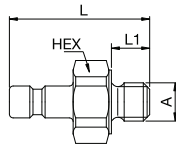

A

HEX L L1

M3 02SFAM03MXN

6 11 3

02SFIM Plug without valve, Female Thread

Nickel-plated brass

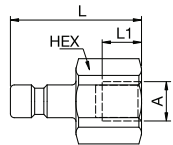

A

HEX L L1

M3 02SFIM03MXN

6 10 3

02SFTF Plug without valve, Hose Barb

Nickel-plated brass

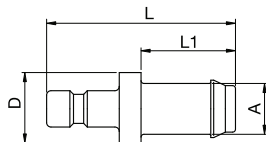

A

L L1 D

2 02SFTF02MXN

12 5.5 4

3 02SFTF03MXN

13 6.5 5

02SFTS Plug without valve, Panel Mount with Hose Barb

Nickel-plated brass

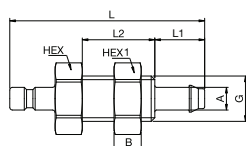

A

HEX HEX1 B G L L1 L2

2 02SFTS02MXN

7 7 3 M5 22 5.5 8

The mini series offer space saving solutions for frequent disconnection of tubing or pneumatic tools.

- Compact and ergonomic
- Easy identification of circuits
- Easy disconnection / single hand operation



own Profile

KA Single Shut-Off

Working Pressure*:
up to 20 bar

Material:

- **Coupling:** Technical polymer, nickel plated brass
- **Plug:** nickel plated brass
- **Seals:** NBR

Working Temperature:
-20°C up to +60°C (NBR)

Flow Rate Air:

165 NI/min.
inlet pressure 6 bar, pressure drop 0.6 bar

Single Shut-Off

0171 Coupler with valve, Male BSPT and Parallel Metric Thread

Technical polymer, Nickel-plated brass, NBR

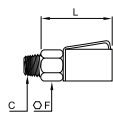

DN	C		E	F	L	Kg
2	M7x1	0171 02 55 01	6	10	21	
2	R1/8	0171 02 10 01	7.5	10	21	
2	R1/8	0171 02 10 02	7.5	10	21	
2	R1/8	0171 02 10 03	7.5	10	21	
2	R1/8	0171 02 10 04	7.5	10	21	
2	R1/8	0171 02 10 05	7.5	10	21	

Single shut-off
Mini Series (DN 2): single shut-off= 165 NI/min

Single Shut-Off

0184 Plug without valve, Male BSPT Thread

Nickel-plated brass



DN	C		F	L	Kg
2	R1/8	0184 02 10	10	13	

Probe without Shut-off

0181 Plug without valve, Male BSPT Thread

Nickel-plated brass

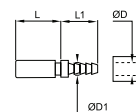

DN	ØD	ØD1		L	L1	Kg
2	3	3.3	0181 03 04	11.5	13.5	

Probe without Shut-off

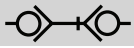

Double Shut-off

0183 Plug with valve, Male BSPT Thread

Nickel-plated brass, NBR



DN	C		F	L	Kg
2	R1/8	 0183 02 10	10	13	

Probe with Shut-off



Mini industrial coupling, can be used with various media. Coupling system with single-hand operation. This system is extremely easy to operate and stands out for its small installation dimensions.

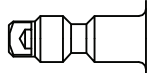

German Profile

- Available on request:
 - in brass material with nickel plating
 - with additional end connections
 - other seals for different temperature ranges and fluids

KA
Single Shut-Off

Working Pressure*:
up to 35 bar

Material:

- Coupling: Brass
- Plug: Brass
- Seals: NBR

Working Temperature:
-20°C up to +100°C (NBR)

Flow Rate Air:
120 l/min.
inlet pressure 6 bar, pressure drop 0.5 bar

Flow Rate Water:
1.8 l/min.
pressure drop 0.5 bar

* maximum static working pressure with design factor 4 to 1.

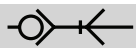

Single Shut-Off

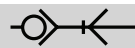

Single Shut-Off

50KAAW Coupler with valve, Male Thread

Brass, NBR

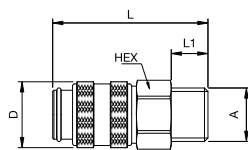

A		HEX	L	L1	D
G1/8	50KAAW10MPXS	14	36	7	16
G1/4	50KAAW13MPXS	17	38	9	16

50KATF Coupler with valve, Hose Barb

Brass, NBR

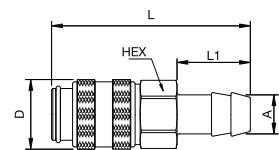
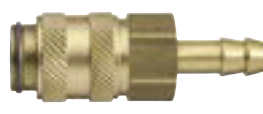

A		HEX	L	L1	D
4	50KATF04MPXS	14	46	17	16
6	50KATF06MPXS	14	46	17	16

50KAIW Coupler with valve, Female Thread

Brass, NBR

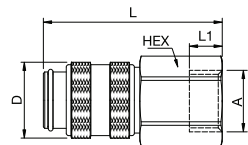

A		HEX	L	L1	D
G1/8	50KAIW10MPXS	14	36	9	16
G1/4	50KAIW13MPXS	17	38	9	16

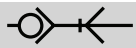

Single Shut-Off

50SAW Plug without valve, Male Thread

Brass

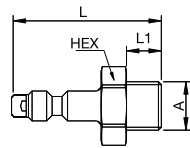

A 

HEX L L1

G1/8 50SAW10MXX

14 30 7

50FIW Plug without valve, Female Thread

Brass

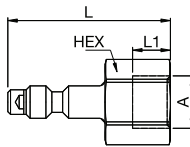

A 

HEX L L1

G1/8 50FIW10MXX

14 30 7

50SFTF Plug without valve, Hose Barb

Brass

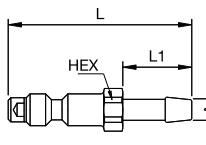

A 

HEX L L1

4 50SFTF04MXX

7 35 13

6 50SFTF06MXX

7 35 13



Euro Profile



Mini industrial coupling with internationally used profile. Frequent use in medical technology and chemistry/pharmacy. Coupling system with single-hand operation. Wide range of applications with different media.

- Available on request:
 - with additional end connections
 - other seals for different temperature ranges and fluids

KA Single Shut-Off

Working Pressure*:
up to 35 bar

Material:

- Coupling: Brass
- Plug: Brass
- Seals: NBR

Working Temperature:
-20°C up to +100°C (NBR)

Flow Rate Air:
165 l/min.
inlet pressure 6 bar, pressure drop 0.5 bar

Flow Rate Air:
1.5 l/min.
pressure drop 0.5 bar

KB Double Shut-Off

Working Pressure*:
up to 35 bar

Material:

- Coupling: Brass
- Plug: Brass
- Seals: NBR

Working Temperature:
-20°C up to +100°C (NBR)

Flow Rate Air:
130 l/min.
inlet pressure 6 bar, pressure drop 0.5 bar

Flow Rate Air:
1.2 l/min.
pressure drop 0.5 bar

* maximum static working pressure with design factor 4 to 1.

Single Shut-Off

Single Shut-Off

20KAA Coupler with valve, Male Thread

Brass, NBR

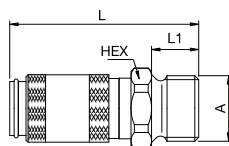

A		HEX	L	L1	D	Version
M5	20KAAM05MPX	9	26	5	10	Brass
M5	20KAAM05MPN	9	26	5	10	Nickel-plated brass
G1/8	20KAAW10MPX	11	28	7	10	Brass
G1/8	20KAAW10MPN	11	28	7	10	Nickel-plated brass

20KAI Coupler with valve, Female Thread

Brass, NBR

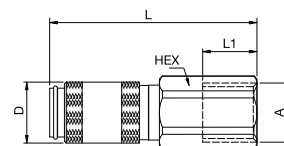

A		HEX	L	L1	D	Version
M5	20KAIM05MPX	9	26	5	10	Brass
M5	20KAIM05MPN	9	26	5	10	Nickel-plated brass
G1/8	20KAIW10MPX	12	28	7	10	Brass
G1/8	20KAIW10MPN	12	28	7	10	Nickel-plated brass

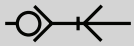

Single Shut-Off

20KATF Coupler with valve, Hose Barb

Brass, NBR

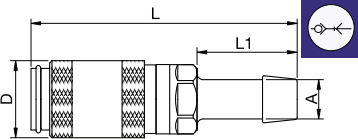

A		L	L1	D	Version
3	20KATF03MPX	35	13	10	Brass
3	20KATF03MPN	35	13	10	Nickel-plated brass
4	20KATF04MPX	35	13	10	Brass
4	20KATF04MPN	35	13	10	Nickel-plated brass
5	20KATF05MPX	35	13	10	Brass
5	20KATF05MPN	35	13	10	Nickel-plated brass

20KAKO Coupler with valve, with Plastic Hose Connection

Brass, NBR

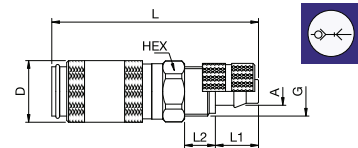

A		HEX	G	L	L1	L2	D	Version
3 x 4	20KAKO04MPX	9	M7x0.5	34	7	5	10	Brass
3 x 4	20KAKO04MPN	9	M7x0.5	34	7	5	10	Nickel-plated brass
3 x 5	20KAKO05MPX	9	M7x0.5	34	7	5	10	Brass
3 x 5	20KAKO05MPN	9	M7x0.5	34	7	5	10	Nickel-plated brass
4 x 6	20KAKO06MPX	9	M8x0.5	34	7	5	10	Brass
4 x 6	20KAKO06MPN	9	M8x0.5	34	7	5	10	Nickel-plated brass

20KAKS Coupler with valve, Panel Mount with Plastic Hose Connection

Brass, NBR

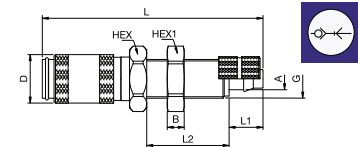
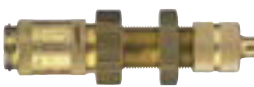

A		HEX	HEX1	B	G	L	L1	L2	D	Version
3 x 4	20KAKS04MPX	12	11	3	M7x0.5	45	7	17	10	Brass
3 x 4	20KAKS04MPN	12	11	3	M7x0.5	45	7	17	10	Nickel-plated brass
3 x 5	20KAKS05MPX	12	11	3	M7x0.5	45	7	17	10	Brass
3 x 5	20KAKS05MPN	12	11	3	M7x0.5	45	7	17	10	Nickel-plated brass
4 x 6	20KAKS06MPX	12	11	3	M8x0.5	45	7	17	10	Brass
4 x 6	20KAKS06MPN	12	11	3	M8x0.5	45	7	17	10	Nickel-plated brass

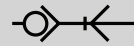

Single Shut-Off

20KATS Coupler with valve, Panel Mount with Hose Barb

Brass, NBR

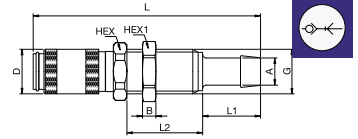

A		HEX	HEX1	B	G	L	L1	L2	D	Version
3	20KATS03MPX	12	11	3	M7x0.5	51	13	17	10	Brass
3	20KATS03MPN	12	11	3	M7x0.5	51	13	17	10	Nickel-plated brass
4	20KATS04MPX	12	11	3	M7x0.5	51	13	17	10	Brass
4	20KATS04MPN	12	11	3	M7x0.5	51	13	17	10	Nickel-plated brass

20KARP Coupler with valve, Push-In

Nickel-plated brass, NBR

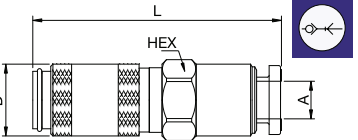

A		HEX	L	D
4	20KARP04MPN	10	35	10

20SFA Plug without valve, Male Thread

Brass

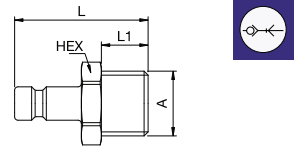

A		HEX	L	L1	Version
M5	20SFAM05MXX	7	18	5	Brass
M5	20SFAM05MXN	9087 20 19	7	18	Nickel-plated brass
G1/8	20SFAW10MXX	11	20	7	Brass
G1/8	20SFAW10MXN	9087 20 10	11	20	Nickel-plated brass

20SFI Plug without valve, Female Thread

Brass

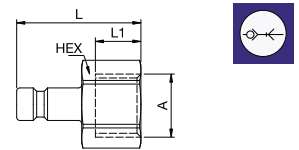

A		HEX	L	L1	Version
M5	20SFIM05MXX	7	17	5	Brass
M5	20SFIM05MXN	9086 20 19	7	17	Nickel-plated brass
G1/8	20SFIW10MXX	12	19	7	Brass
G1/8	20SFIW10MXN	9086 20 10	12	19	Nickel-plated brass

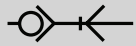

Single Shut-Off

20SFTF Plug without valve, Hose Barb

Brass

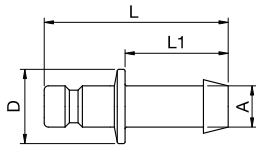

A			L	L1	D	Version
3			24	13	7	Brass
3			24	13	7	Nickel-plated brass
4			24	13	7	Brass
4			24	13	7	Nickel-plated brass
5			22	13	9	Brass
5			22	13	9	Nickel-plated brass

20SFK0 Plug without valve, with Plastic Hose Connection

Brass

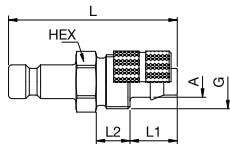

A		HEX	G	L	L1	L2	Version
3 x 4		7	M7x0.5	25	7	5	Brass
3 x 4		7	M7x0.5	25	7	5	Nickel-plated brass
3 x 5		7	M7x0.5	25	7	5	Brass
3 x 5		7	M7x0.5	25	7	5	Nickel-plated brass
4 x 6		8	M8x0.5	25	7	5	Brass
4 x 6		8	M8x0.5	25	7	5	Nickel-plated brass

20SFKS Plug without valve, Panel Mount with Plastic Hose Connection

Brass

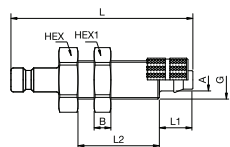

A		HEX	HEX1	B	G	L	L1	L2	Version
3 x 4		11	11	3	M7x0.5	38	7	17	Brass
3 x 4		11	11	3	M7x0.5	38	7	17	Nickel-plated brass
3 x 5		11	11	3	M7x0.5	38	7	17	Brass
3 x 5		11	11	3	M7x0.5	38	7	17	Nickel-plated brass
4 x 6		12	12	3	M8x0.5	38	7	17	Brass
4 x 6		12	12	3	M8x0.5	38	7	17	Nickel-plated brass

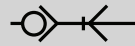

Single Shut-Off

20SFTS Plug without valve, Panel Mount with Hose Barb

Brass

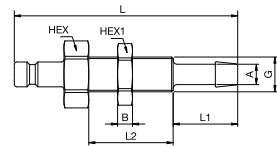

A			HEX	HEX1	B	G	L	L1	L2	Version
3			12	11	3.5	M7x0.5	45	13	18	Brass
3			12	11	3.5	M7x0.5	45	13	18	Nickel-plated brass
4			12	11	3	M7x0.5	45	13	17	Brass
4			12	11	3	M7x0.5	45	13	17	Nickel-plated brass

20SFRP Plug without valve, Push-In

Nickel-plated brass, NBR

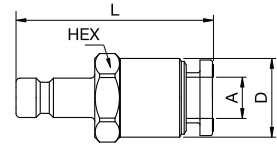

A		HEX	L	D
4		10	35	10

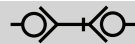

Double Shut-off

20KBA Coupler with valve, Male Thread

Brass, NBR

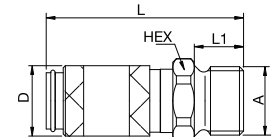

A			HEX	L	L1	D	Version
M5			9	26	5	10	Brass
M5			9	26	5	10	Nickel-plated brass
G1/8			11	28	7	10	Brass
G1/8			11	28	7	10	Nickel-plated brass

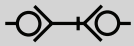

Double Shut-off

20KBI Coupler with valve, Female Thread

Brass, NBR

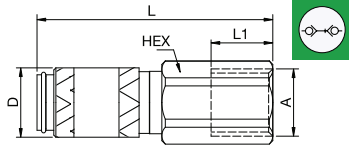

A	Version	HEX	L	L1	D	Version
M5	20KBIM05MPX	9	26	5	10	Brass
M5	20KBIM05MPN	9	26	5	10	Nickel-plated brass
G1/8	20KBIW10MPX	12	28	7	10	Brass
G1/8	20KBIW10MPN	12	28	7	10	Nickel-plated brass

20KBT Coupler with valve, Hose Barb

Brass, NBR

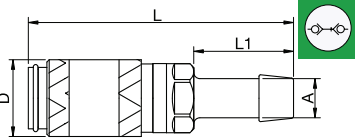

A	Version	L	L1	D	Version
3	20KBTf03MPX	35	13	10	Brass
3	20KBTf03MPN	35	13	10	Nickel-plated brass
4	20KBTf04MPX	35	13	10	Brass
4	20KBTf04MPN	35	13	10	Nickel-plated brass
5	20KBTf05MPX	35	13	10	Brass
5	20KBTf05MPN	35	13	10	Nickel-plated brass

20KBKO Coupler with valve, with Plastic Hose Connection

Brass, NBR

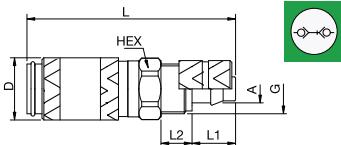

A	Version	HEX	G	L	L1	L2	D	Version
3 x 4	20KBKO04MPX	9	M7x0.5	34	7	5	10	Brass
3 x 4	20KBKO04MPN	9	M7x0.5	34	7	5	10	Nickel-plated brass
3 x 5	20KBKO05MPX	9	M7x0.5	34	7	5	10	Brass
3 x 5	20KBKO05MPN	9	M7x0.5	34	7	5	10	Nickel-plated brass
4 x 6	20KBKO06MPX	9	M8x0.5	34	7	5	10	Brass
4 x 6	20KBKO06MPN	9	M8x0.5	34	7	5	10	Nickel-plated brass

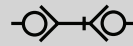

Double Shut-off

20KBKS Coupler with valve, Panel Mount with Plastic Hose Connection

Brass, NBR

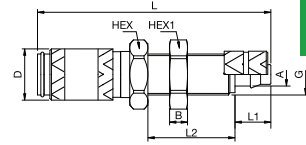
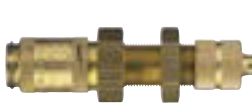

A	Version	HEX	HEX1	B	G	L	L1	L2	D	Version
3 x 4	20KBKS04MPX	12	11	3	M7x0.5	45	7	17	10	Brass
3 x 4	20KBKS04MPN	12	11	3	M7x0.5	45	7	17	10	Nickel-plated brass
3 x 5	20KBKS05MPX	12	11	3	M7x0.5	45	7	17	10	Brass
3 x 5	20KBKS05MPN	12	11	3	M7x0.5	45	7	17	10	Nickel-plated brass
4 x 6	20KBKS06MPX	12	12	3.5	M8x0.5	45	7	17	10	Brass
4 x 6	20KBKS06MPN	12	12	3.5	M8x0.5	45	7	17	10	Nickel-plated brass

20KBTS Coupler with valve, Panel Mount with Hose Barb

Brass, NBR

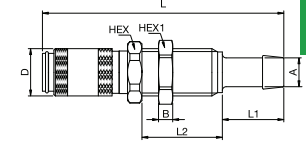

A	Version	HEX	HEX1	B	G	L	L1	L2	D	Version
3	20KBTS03MPX	12	11	3	M7x0.5	51	13	17	10	Brass
3	20KBTS03MPN	12	11	3	M7x0.5	51	13	17	10	Nickel-plated brass
4	20KBTS04MPX	12	11	3	M7x0.5	51	13	17	10	Brass
4	20KBTS04MPN	12	11	3	M7x0.5	51	13	17	10	Nickel-plated brass

20KBRP Coupler with valve, Push-In

Nickel-plated brass, NBR

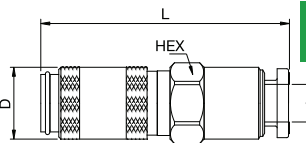

A	Version	HEX	L	D
4	20KBRP04MPN	10	35	10

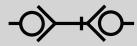

Double Shut-off

20SBA Plug with valve, Male Thread

Brass, NBR

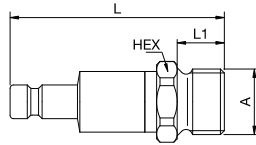

A		HEX	L	L1	Version
M5	20SBAM05MPX	9	28	5	Brass
M5	20SBAM05MPN	9	28	5	Nickel-plated brass
G1/8	20SBAW10MPX	11	30	7	Brass
G1/8	20SBAW10MPN	11	30	7	Nickel-plated brass

20SBI Plug with valve, Female Thread

Brass, NBR

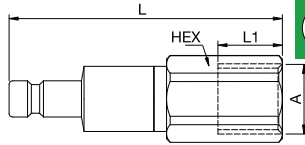

A		HEX	L	L1	Version
M5	20SBIM05MPX	9	26	5	Brass
M5	20SBIM05MPN	9	26	5	Nickel-plated brass
G1/8	20SBIW10MPX	12	30	7	Brass
G1/8	20SBIW10MPN	12	30	7	Nickel-plated brass

20SBTF Plug with valve, Hose Barb

Brass, NBR

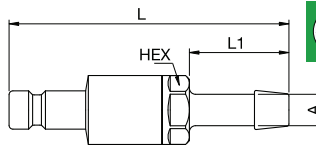

A		HEX	L	L1	Version
3	20SBTF03MPX	8	36	13	Brass
3	20SBTF03MPN	8	36	13	Nickel-plated brass
4	20SBTF04MPX	8	36	13	Brass
4	20SBTF04MPN	8	36	13	Nickel-plated brass
5	20SBTF05MPX	8	36	13	Brass
5	20SBTF05MPN	8	36	13	Nickel-plated brass

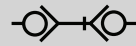

Double Shut-off

20SBKO Plug with valve, with Plastic Hose Connection

Brass, NBR

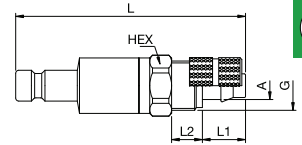

A		HEX	G	L	L1	L2	Version
3 x 4	20SBK004MPX	9	M7x0.5	30.5	7	5	Brass
3 x 4	20SBK004MPN	9	M7x0.5	30.5	7	5	Nickel-plated brass
3 x 5	20SBK005MPX	9	M7x0.5	30.5	7	5	Brass
3 x 5	20SBK005MPN	9	M7x0.5	30.5	7	5	Nickel-plated brass
4 x 6	20SBK006MPX	9	M8x0.5	30.5	7	5	Brass
4 x 6	20SBK006MPN	9	M8x0.5	30.5	7	5	Nickel-plated brass

20SBKS Plug with valve, Panel Mount with Plastic Hose Connection

Brass, NBR

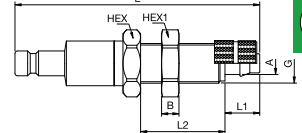

A		HEX	HEX1	B	G	L	L1	L2	D	Version
3 x 4	20SBKS04MPX	12	11	3	M7x0.5	46.5	7	17	10	Brass
3 x 4	20SBKS04MPN	12	11	3	M7x0.5	46.5	7	17	10	Nickel-plated brass
3 x 5	20SBKS05MPX	12	11	3	M7x0.5	46.5	7	17	10	Brass
3 x 5	20SBKS05MPN	12	11	3	M7x0.5	46.5	7	17	10	Nickel-plated brass
4 x 6	20SBKS06MPX	12	12	3.5	M8x0.5	46.5	7	17	10	Brass
4 x 6	20SBKS06MPN	12	12	3.5	M8x0.5	46.5	7	17	10	Nickel-plated brass

20SBTS Plug with valve, Panel Mount with Hose Barb

Brass, NBR

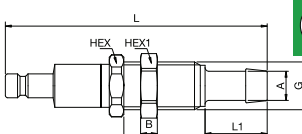
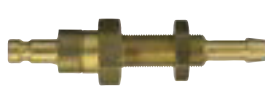

A		HEX	HEX1	B	G	L	L1	L2	Version
3	20SBTS03MPX	12	11	3	M7x0.5	52.5	13	17	Brass
3	20SBTS03MPN	12	11	3	M7x0.5	52.5	13	17	Nickel-plated brass
4	20SBTS04MPX	12	11	3	M7x0.5	52.5	13	17	Brass
4	20SBTS04MPN	12	11	3	M7x0.5	52.5	13	17	Nickel-plated brass

20SBRP Plug with valve, Push-In

Nickel-plated brass, NBR

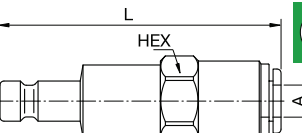

A		HEX	L
3 x 4	20SBRP04MPN	10	34

The mini series offer space saving solutions for frequent disconnection of tubing or pneumatic tools.

- Compact and ergonomic
- Easy identification of circuits
- Easy disconnection / single hand operation



KF Straight-Through

Working Pressure*:
up to 20 bar

Material:

- Coupling: Technical polymer, nickel plated brass
- Plug: nickel plated brass
- Seals: NBR

Working Temperature:
-20°C up to +60°C (NBR)

Flow Rate Air:
165 NI/min.
inlet pressure 6 bar, pressure drop 0.6 bar

Straight-Through

0171 Coupler without valve, Male BSPT Thread

Technical polymer, Nickel-plated brass, NBR

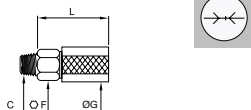

DN	C		F	G	L	Kg
3	R1/8	0171 03 10 01	13	17	24.5	
3	R1/8	0171 03 10 02	13	17	24.5	
3	R1/8	0171 03 10 03	13	17	24.5	
3	R1/8	0171 03 10 04	13	17	24.5	
3	R1/8	0171 03 10 05	13	17	24.5	

Straight-through

Straight-Through

0180 Plug without valve, with Barb Connection for Flexible Tubing

Nickel-plated brass

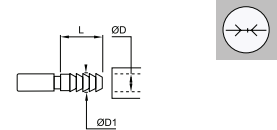

DN	ØD	ØD1		L	Kg
3	4	6	0180 04 00	19	
3	5	6.5	0180 05 00	19	

Probe without Shut-off

0181 Plug without valve, with Barb Connection for Polyamide (PA) Tubing

Nickel-plated brass

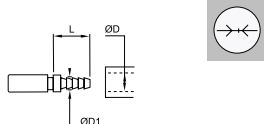

DN	ØD	ØD1		L	Kg
3	4	4.7	0181 04 06	19	

Probe without Shut-off

3150 Plug without valve, with LF 3000 Push-In Connection

Nickel-plated brass, NBR

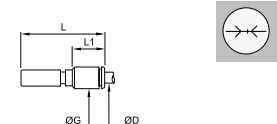

DN	ØD		G	L	L1	Kg
3	4	3150 00 61	8.5	39	18	

Probe without Shut-off



The Standard range offers a robust solution and a good compromise between space and flow performance.

- Robust and adapted to demanding application
- Good corrosion resistance thanks to nickel plating

own Profile

KA
Single Shut-Off

Working Pressure*:
up to 20 bar

Material:

- Coupling: Nickel plated brass
- Plug: Zinc plated blister steel
- Seals: NBR

Working Temperature:
-20°C up to +80°C (NBR)

Flow Rate Air:
480 NI/min.
inlet pressure 6 bar, pressure drop 0.6 bar

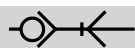

Single Shut-Off

0172 Coupler with valve, Female BSPP Thread

Nickel-plated brass, NBR

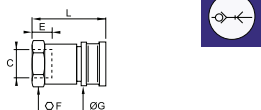

DN	C		E	F	G	L	Kg
5	G1/4	0172 05 13	11	19	21	47	

Standard Series: single shut-off = 480 NI/min

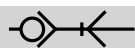

Single Shut-Off

0186 Plug without valve, Female BSPP Thread

Zinc-plated blister steel

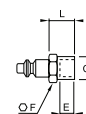

DN	C		E	F	L	Kg
5	G1/4	0186 05 13	12	17	17	

Probe without Shut-off

0187 Plug without valve, Male BSPP Thread

Zinc-plated blister steel

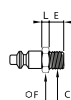

DN	C		E	F	L	Kg
5	G1/8	0187 05 10	7	14	4	
5	G1/4	0187 05 13	9.5	17	5	

Probe without Shut-off

0185 Plug without valve, with Barb Connection for Flexible Tubing

Zinc-plated blister steel

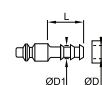

DN	ØD	ØD1		L	Kg
5	4	6	0185 04 00	22.5	
5	7	9	0185 07 00	22.5	
5	10	12.2	0185 10 00	22.5	

Probe without Shut-off

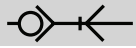

Single Shut-Off

0189 Double Plug

Zinc-plated blister steel



DN 

F L Kg

5 **0189 05 00**

12 4

Probe without Shut-off



Brass/steel industrial coupling with British profile specifically suited to compressed air applications in industry. Coupling system with single-hand operation. High Flow valve for optimum flow and low pressure drop. Versatile due to slim design and light weight.

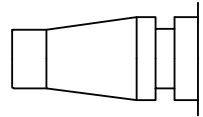

British Profile

- Available on request:
 - with additional end connections
 - other seals for different temperature ranges and fluids

KA Single Shut-Off

Working Pressure*:
up to 35 bar

Material:

- Coupling: Nickel plated brass / steel
- Plug: Nickel plated steel
- Seals: NBR

Working Temperature:
-20°C up to +100°C (NBR)

Flow Rate Air:
890 l/min.
inlet pressure 6 bar, pressure drop 0.5 bar

Flow Rate Water:
11 l/min.
pressure drop 0.5 bar

* maximum static working pressure with design factor 4 to 1.

Single Shut-Off

Single Shut-Off

17KAAK Coupler with valve, Male Thread

Nickel-plated brass/steel, NBR

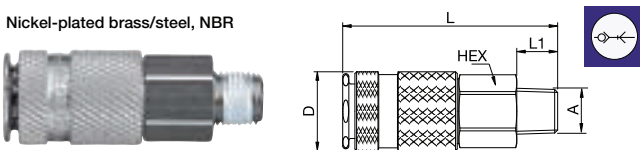

A			HEX	L	L1	D
R1/4	17KAAK13SPN	9105 17 13	19	63	12	23
R3/8	17KAAK17SPN		19	62	12	23
R1/2	17KAAK21SPN	9105 17 21	22	63	17	23

17KATF Coupler with valve, Hose Barb

Nickel-plated brass/steel, NBR

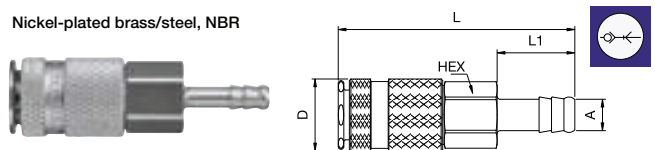

A			HEX	L	L1	D
6	17KATF06SPN		19	76	25	23
8	17KATF08SPN		19	76	25	23
10	17KATF10SPN		19	76	25	23
13	17KATF13SPN		19	76	25	23

17KAIW Coupler with valve, Female Thread

Nickel-plated brass/steel, NBR

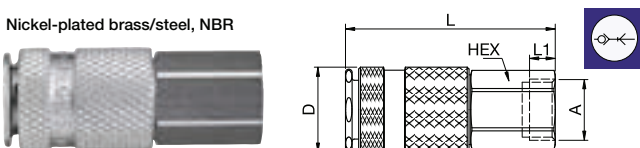

A			HEX	L	L1	D
G1/4	17KAIW13SPN	9114 17 13	19	58	9	23
G3/8	17KAIW17SPN	9114 17 17	19	57	9	23
G1/2	17KAIW21SPN	9114 17 21	24	60	12	23

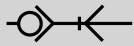

Single Shut-Off

17SFAK Plug without valve, Male Thread

Nickel-plated steel

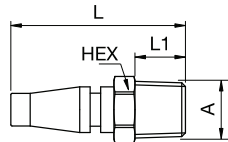

A			HEX	L	L1
R1/8	17SFAK10SXN		11	37	9
R1/4	17SFAK13SXN	9084 17 13	14	42	12

17SFIW Plug without valve, Female Thread

Nickel-plated steel

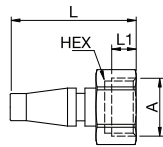

A			HEX	L	L1
G1/8	17SFIW10SXN		14	33	7
G1/4	17SFIW13SXN	9086 17 13	17	36	9

17SFTF Plug without valve, Hose Barb

Nickel-plated steel

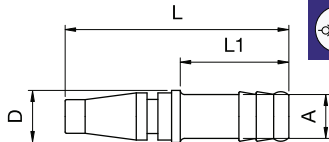

A			L	L1	D
6	17SFTF06SXN		58	25	12
8	17SFTF08SXN		52	25	12
10	17SFTF10SXN		52	25	12



Mini industrial coupling with the world's most popular profile in this nominal diameter. Above average flow performance for liquid and gaseous media.
Coupling system with single-hand operation. Small dimensions and large bandwidth in materials and valve variants.

- Available on request:
 - with additional end connections
 - other seals for different temperature ranges and fluids

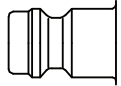

Euro Profile

Dust Protections  (P. 357)
for Coupling Part.-No. SK16S

KA Single Shut-Off

Working Pressure*:
up to 35 bar

Material:

- Coupling: Brass
- Plug: Brass
- Seals: NBR

Working Temperature:
-20°C up to +100°C (NBR)

Flow Rate Air:
550 l/min.
inlet pressure 6 bar, pressure drop 0.5 bar

Flow Rate Water:
7 l/min.
pressure drop 0.5 bar

KB Double Shut-Off

Working Pressure*:
up to 35 bar

Material:

- Coupling: Brass
- Plug: Brass
- Seals: NBR

Working Temperature:
-20°C up to +100°C (NBR)

Flow Rate Air:
310 l/min.
inlet pressure 6 bar, pressure drop 0.5 bar

Flow Rate Water:
2.7 l/min.
pressure drop 0.5 bar

KL Dry-break

Working Pressure*:
up to 8 bar

Material:

- Coupling: Brass
- Plug: Brass
- Seals: NBR

Working Temperature:
-20°C up to +100°C (NBR)

Flow Rate Water:
2.7 l/min.
pressure drop 0.5 bar

* maximum static working pressure with design factor 4 to 1.

 Single Shut-Off

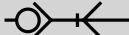
 Single Shut-Off

21KAA Coupler with valve, Male Thread

Brass, NBR

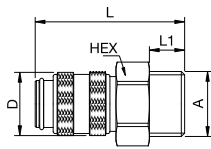

A	Version	HEX	L	L1	D	Version
G1/8	21KAAW10MPX	14	36	7	16	Brass
G1/8	21KAAW10MPN	14	36	7	16	Nickel-plated brass
G1/4	21KAAW13MPX	17	38	9	16	Brass
G1/4	21KAAW13MPN	17	38	9	16	Nickel-plated brass
G3/8	21KAAW17MPX	19	38	9	16	Brass
G3/8	21KAAW17MPN	19	38	9	16	Nickel-plated brass
M10 x 1	21KAAD10MPX	14	37	8	16	Brass
M10 x 1	21KAAD10MPN	14	37	8	16	Nickel-plated brass
M12 x 1.5	21KAAD12MPX	17	39	10	16	Brass
M12 x 1.5	21KAAD12MPN	17	39	10	16	Nickel-plated brass
M14 x 1.5	21KAAD14MPX	17	39	10	16	Brass
M14 x 1.5	21KAAD14MPN	17	39	10	16	Nickel-plated brass

21KAI Coupler with valve, Female Thread

Brass, NBR

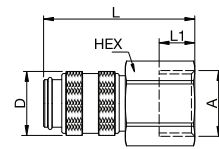

A	Version	HEX	L	L1	D	Version
G1/8	21KAIW10MPX	14	36	9	16	Brass
G1/8	21KAIW10MPN	14	36	9	16	Nickel-plated brass
G1/4	21KAIW13MPX	17	38	9	16	Brass
G1/4	21KAIW13MPN	17	38	9	16	Nickel-plated brass
G3/8	21KAIW17MPX	19	38	9	16	Brass
G3/8	21KAIW17MPN	19	38	9	16	Nickel-plated brass
M12 x 1.5	21KAIM12MPX	17	38	6	16	Brass
M12 x 1.5	21KAIM12MPN	17	38	6	16	Nickel-plated brass
M14 x 1.5	21KAIM14MPX	17	38	6	16	Brass
M14 x 1.5	21KAIM14MPN	17	38	6	16	Nickel-plated brass

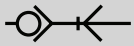

Single Shut-Off

21KATF Coupler with valve, Hose Barb

Brass, NBR

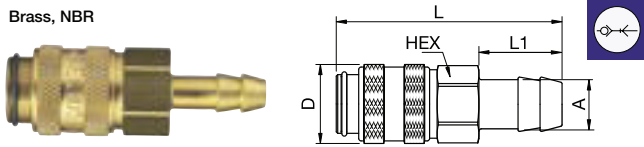

A	Version	HEX	L	L1	D	Version
4	21KATF04MPX	14	46	17	16	Brass
4	21KATF04MPN	14	46	17	16	Nickel-plated brass
5	21KATF05MPX	14	46	17	16	Brass
5	21KATF05MPN	14	46	17	16	Nickel-plated brass
6	21KATF06MPX	14	46	17	16	Brass
6	21KATF06MPN	14	46	17	16	Nickel-plated brass
8	21KATF08MPX	14	46	17	16	Brass
8	21KATF08MPN	14	46	17	16	Nickel-plated brass
9	21KATF09MPX	14	46	17	16	Brass
9	21KATF09MPN	14	46	17	16	Nickel-plated brass
10	21KATF10MPX	14	46	17	16	Brass
10	21KATF10MPN	14	46	17	16	Nickel-plated brass

21KAKO Coupler with valve, with Plastic Hose Connection

Brass, NBR

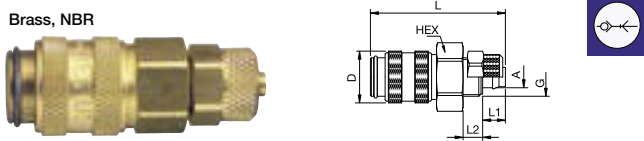

A	Version	HEX	G	L	L1	L2	D	Version
4 x 6	21KAKO06MPX	14	M10x1	42	7	6	16	Brass
4 x 6	21KAKO06MPN	14	M10x1	42	7	6	16	Nickel-plated brass
6 x 8	21KAKO08MPX	14	M12x1	42	7	6	16	Brass
6 x 8	21KAKO08MPN	14	M12x1	42	7	6	16	Nickel-plated brass

21KAKS Coupler with valve, Panel Mount with Plastic Hose Connection

Brass, NBR

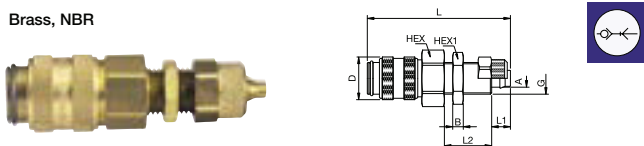

A	Version	HEX	HEX1	B	G	L	L1	L2	D	Version
4 x 6	21KAKS06MPX	14	12	3	M10x1	54	7	18	16	Brass
4 x 6	21KAKS06MPN	14	12	3	M10x1	54	7	18	16	Nickel-plated brass
6 x 8	21KAKS08MPX	17	17	4	M12x1	54	7	18	16	Brass
6 x 8	21KAKS08MPN	17	17	4	M12x1	54	7	18	16	Nickel-plated brass

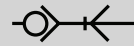

Single Shut-Off

21KATS Coupler with valve, Panel Mount with Hose Barb

Brass, NBR

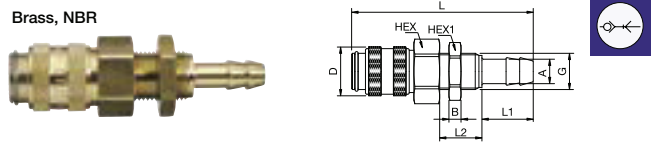

A	Version	HEX	HEX1	B	G	L	L1	L2	D	Version
4	21KATS04MPX	12	12	4	M10x1	60	17	14	16	Brass
4	21KATS04MPN	12	12	4	M10x1	60	17	14	16	Nickel-plated brass
5	21KATS05MPX	17	17	4	M12x1	60	17	14	16	Brass
5	21KATS05MPN	17	17	4	M12x1	60	17	14	16	Nickel-plated brass
6	21KATS06MPX	17	17	4	M12x1	60	17	14	16	Brass
6	21KATS06MPN	17	17	4	M12x1	60	17	14	16	Nickel-plated brass
8	21KATS08MPX	17	17	4	M12x1	60	17	14	16	Brass
8	21KATS08MPN	17	17	4	M12x1	60	17	14	16	Nickel-plated brass
9	21KATS09MPX	17	19	4	M14x1	60	17	14	16	Brass
9	21KATS09MPN	17	19	4	M14x1	60	17	14	16	Nickel-plated brass
10	21KATS10MPX	17	19	4	M14x1	60	17	14	16	Brass
10	21KATS10MPN	17	19	4	M14x1	60	17	14	16	Nickel-plated brass

21KAKK Coupler with valve, Plastic Hose Connection with Spring Guard

Brass, NBR

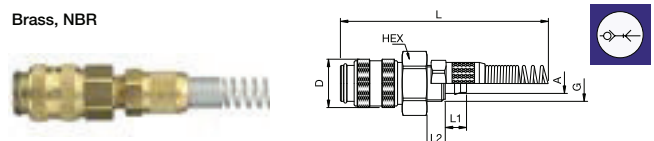

A	Version	HEX	G	L	L1	L2	D	Version
4 x 6	21KAKK06MPX	14	M10x1	125	7	6	16	Brass
4 x 6	21KAKK06MPN	14	M10x1	125	7	6	16	Nickel-plated brass
6 x 8	21KAKK08MPX	14	M10x1	130	7	6	16	Brass
6 x 8	21KAKK08MPN	14	M10x1	130	7	6	16	Nickel-plated brass

21KARP Coupler with valve, Push-In

Nickel-plated brass, NBR

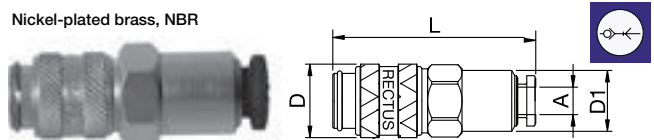

A	Version	HEX	L	D	D1
6	21KARP06MPN	14	43.5	16	13.3
8	21KARP08MPN	17	48	16	15.3

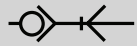

Single Shut-Off

21SFA Plug without valve, Male Thread

Brass

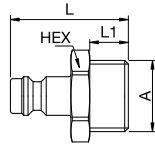

A			HEX	L	L1	Version
G1/8			14	25	7	Brass
G1/8			14	25	7	Nickel-plated brass
G1/4			17	28	9	Brass
G1/4			17	28	9	Nickel-plated brass
G3/8			19	28	9	Brass
G3/8			19	28	9	Nickel-plated brass
M10 x 1			14	26	8	Brass
M10 x 1			14	26	8	Nickel-plated brass
M12 x 1.5			17	28	10	Brass
M12 x 1.5			17	28	10	Nickel-plated brass
M14 x 1.5			17	28	10	Brass
M14 x 1.5			17	28	10	Nickel-plated brass

21SFI Plug without valve, Female Thread

Brass

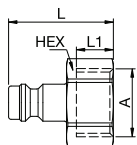

A			HEX	L	L1	Version
G1/8			14	25	8	Brass
G1/8			14	25	8	Nickel-plated brass
G1/4			17	25	9	Brass
G1/4			17	25	9	Nickel-plated brass
G3/8			19	26	9	Brass
G3/8			19	26	9	Nickel-plated brass
M12 x 1.5			17	27	10	Brass
M12 x 1.5			17	27	10	Nickel-plated brass
M14 x 1.5			17	27	10	Brass
M14 x 1.5			17	27	10	Nickel-plated brass

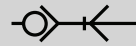

Single Shut-Off

21SFTF Plug without valve, Hose Barb

Brass

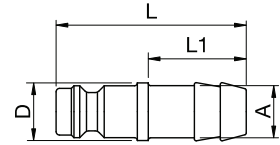

A			L	L1	D	Version
4			32	17	9	Brass
4			32	17	9	Nickel-plated brass
5			32	17	9	Brass
5			32	17	9	Nickel-plated brass
6			32	17	9	Brass
6			32	17	9	Nickel-plated brass
8			32	17	9	Brass
8			32	17	9	Nickel-plated brass
9			33	17	10	Brass
9			33	17	10	Nickel-plated brass
10			33	17	12	Brass
10			33	17	12	Nickel-plated brass

21SFK0 Plug without valve, with Plastic Hose Connection

Brass

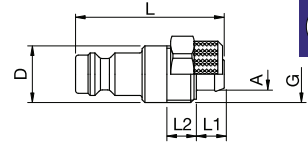

A			G	L	L1	L2	D	Version
4 x 6			M10x1	32	6	6	10	Brass
4 x 6			M10x1	32	6	6	10	Nickel-plated brass
6 x 8			M12x1	32	6	6	12	Brass
6 x 8			M12x1	32	6	6	12	Nickel-plated brass

21SFKS Plug without valve, Panel Mount with Plastic Hose Connection

Brass

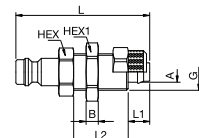

A		HEX	HEX1	B	G	L	L1	L2	Version
4 x 6		14	12	3	M10x1	43	7	18	Brass
4 x 6		14	12	3	M10x1	43	7	18	Nickel-plated brass
6 x 8		14	17	4	M12x1	44	7	18	Brass
6 x 8		14	17	4	M12x1	44	7	18	Nickel-plated brass



Single Shut-Off

21SFTS Plug without valve, Panel Mount with Hose Barb

Brass

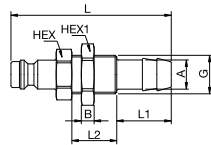

A		HEX	HEX1	B	G	L	L1	L2	Version
4	21SFTS04MXX	14	14	3	M10x1	50	17	14	Brass
4	21SFTS04MXN 9095 21 04	14	14	3	M10x1	50	17	14	Nickel-plated brass
5	21SFTS05MXX	14	17	4	M12x1	50	17	14	Brass
5	21SFTS05MXN	14	17	4	M12x1	50	17	14	Nickel-plated brass
6	21SFTS06MXX	14	17	4	M12x1	50	17	14	Brass
6	21SFTS06MXN 9095 21 06	14	17	4	M12x1	50	17	14	Nickel-plated brass
8	21SFTS08MXX	14	17	4	M12x1	50	17	14	Brass
8	21SFTS08MXN 9095 21 08	14	17	4	M12x1	50	17	14	Nickel-plated brass

21SFKK Plug without valve, Plastic Hose Connection with Spring Guard

Brass

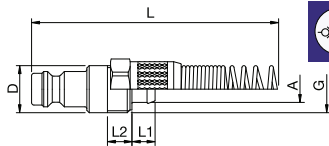

A		G	L	L1	L2	D	Version
4 x 6	21SFKK06MXX	M10x1	115	6	6	10	Brass
4 x 6	21SFKK06MXN	M10x1	115	6	6	10	Nickel-plated brass
6 x 8	21SFKK08MXX	M12x1	120	6	6	12	Brass
6 x 8	21SFKK08MXN	M12x1	120	6	6	12	Nickel-plated brass

21SFRP Plug without valve, Push-In

Nickel-plated brass, NBR

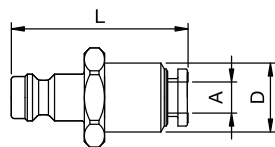

A		HEX	L	D
6	21SFRP06MPN	14	30.5	13.3
8	21SFRP08MPN	17	37	15.3

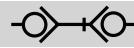

Double Shut-off

21KBA Coupler with valve, Male Thread

Brass, NBR

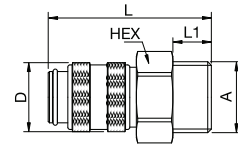

A		HEX	L	L1	D	Version
G1/8	21KBAW10MPX	14	36	7	16	Brass
G1/8	21KBAW10MPN 9201 21 10	14	36	7	16	Nickel-plated brass
G1/4	21KBAW13MPX	17	38	9	16	Brass
G1/4	21KBAW13MPN 9201 21 13	17	38	9	16	Nickel-plated brass
G3/8	21KBAW17MPX	19	38	9	16	Brass
G3/8	21KBAW17MPN	19	38	9	16	Nickel-plated brass
M10 x 1	21KBAD10MPX	14	37	8	16	Brass
M10 x 1	21KBAD10MPN	14	37	8	16	Nickel-plated brass
M12 x 1.5	21KBAD12MPX	17	39	10	16	Brass
M12 x 1.5	21KBAD12MPN	17	39	10	16	Nickel-plated brass
M14 x 1.5	21KBAD14MPX	17	39	10	16	Brass
M14 x 1.5	21KBAD14MPN	17	39	10	16	Nickel-plated brass

21KBI Coupler with valve, Female Thread

Brass, NBR

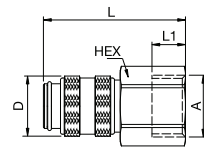

A		HEX	L	L1	D	Version
G1/8	21KBIW10MPX	14	36	9	16	Brass
G1/8	21KBIW10MPN 9214 21 10	14	36	9	16	Nickel-plated brass
G1/4	21KBIW13MPX	17	38	9	16	Brass
G1/4	21KBIW13MPN 9214 21 13	17	38	9	16	Nickel-plated brass
G3/8	21KBIW17MPX	19	38	9	16	Brass
G3/8	21KBIW17MPN	19	38	9	16	Nickel-plated brass
M12 x 1.5	21KBIM12MPX	17	38	6	16	Brass
M12 x 1.5	21KBIM12MPN	17	38	6	16	Nickel-plated brass
M14 x 1.5	21KBIM14MPX	17	38	6	16	Brass
M14 x 1.5	21KBIM14MPN	17	38	6	16	Nickel-plated brass

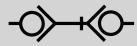

Double Shut-off

21KBTF Coupler with valve, Hose Barb

Brass, NBR

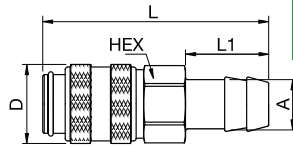

A		HEX	L	L1	D	Version
4	21KBTF04MPX	14	46	17	16	Brass
4	21KBTF04MPN 9223 21 04	14	46	17	16	Nickel-plated brass
5	21KBTF05MPX	14	46	17	16	Brass
5	21KBTF05MPN	14	46	17	16	Nickel-plated brass
6	21KBTF06MPX	14	46	17	16	Brass
6	21KBTF06MPN 9223 21 06	14	46	17	16	Nickel-plated brass
8	21KBTF08MPX	14	46	17	16	Brass
8	21KBTF08MPN 9223 21 08	14	46	17	16	Nickel-plated brass
9	21KBTF09MPX	14	46	17	16	Brass
9	21KBTF09MPN	14	46	17	16	Nickel-plated brass
10	21KBTF10MPX	14	46	17	16	Brass
10	21KBTF10MPN	14	46	17	16	Nickel-plated brass

21KBKO Coupler with valve, with Plastic Hose Connection

Brass, NBR

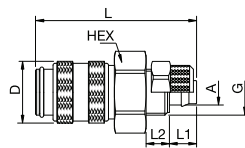

A		HEX	G	L	L1	L2	D	Version
4 x 6	21KBKO06MPX	14	M10x1	42	7	6	16	Brass
4 x 6	21KBKO06MPN	14	M10x1	42	7	6	16	Nickel-plated brass
6 x 8	21KBKO08MPX	14	M12x1	42	7	6	16	Brass
6 x 8	21KBKO08MPN	14	M12x1	42	7	6	16	Nickel-plated brass

21KBKS Coupler with valve, Panel Mount with Plastic Hose Connection

Brass, NBR

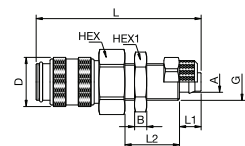
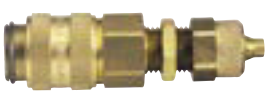

A		HEX	HEX1	B	G	L	L1	L2	D	Version
4 x 6	21KBKS06MPX	14	12	3	M10x1	54	7	18	16	Brass
4 x 6	21KBKS06MPN	14	12	3	M10x1	54	7	18	16	Nickel-plated brass
6 x 8	21KBKS08MPX	17	17	4	M12x1	54	7	18	16	Brass
6 x 8	21KBKS08MPN	17	17	4	M12x1	54	7	18	16	Nickel-plated brass

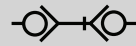

Double Shut-off

21KBTS Coupler with valve, Panel Mount with Hose Barb

Brass, NBR

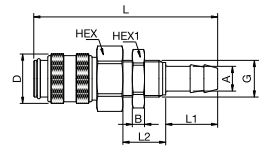

A		HEX	HEX1	B	G	L	L1	L2	D	Version
4	21KBTS04MPX	14	14	3	M10x1	60	17	14	16	Brass
4	21KBTS04MPN 9226 21 04	14	14	3	M10x1	60	17	14	16	Nickel-plated brass
5	21KBTS05MPX	17	17	4	M12x1	60	17	14	16	Brass
5	21KBTS05MPN	17	17	4	M12x1	60	17	14	16	Nickel-plated brass
6	21KBTS06MPX	17	17	4	M12x1	60	17	14	16	Brass
6	21KBTS06MPN 9226 21 06	17	17	4	M12x1	60	17	14	16	Nickel-plated brass
8	21KBTS08MPX	17	17	4	M12x1	60	17	14	16	Brass
8	21KBTS08MPN 9226 21 08	17	17	4	M12x1	60	17	14	16	Nickel-plated brass
9	21KBTS09MPX	17	19	4	M12x1	60	17	14	16	Brass
9	21KBTS09MPN	17	19	4	M12x1	60	17	14	16	Nickel-plated brass
10	21KBTS10MPX	17	19	4	M14x1	60	17	14	16	Brass
10	21KBTS10MPN	17	19	4	M14x1	60	17	14	16	Nickel-plated brass

21KBKK Coupler with valve, Plastic Hose Connection with Spring Guard

Brass, NBR

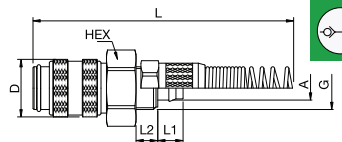

A		HEX	G	L	L1	L2	D	Version
4 x 6	21KBKK06MPX	14	M10x1	125	7	6	16	Brass
4 x 6	21KBKK06MPN	14	M10x1	125	7	6	16	Nickel-plated brass
M12 x 1	21KBKK08MPX	14	M10x1	130	7	6	16	Brass
M12 x 1	21KBKK08MPN	14	M10x1	130	7	6	16	Nickel-plated brass

21KBRP Coupler with valve, Push-In

Nickel-plated brass, NBR

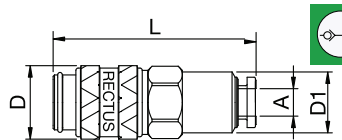

A		HEX	L	D	D1
6	21KBRP06MPN	14	43.5	16	13.3
8	21KBRP08MPN	17	48	16	15.3

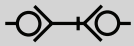

Double Shut-off

21SBA Plug with valve, Male Thread

Brass, NBR

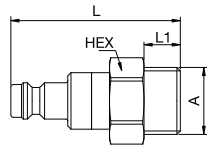

A			HEX	L	L1	Version
G1/8			14	40	7	Brass
G1/8			14	40	7	Nickel-plated brass
G1/4			17	42	9	Brass
G1/4			17	42	9	Nickel-plated brass
G3/8			19	42	9	Brass
G3/8			19	42	9	Nickel-plated brass
M10 x 1			14	41	8	Brass
M10 x 1			14	41	8	Nickel-plated brass
M12 x 1.5			17	43	10	Brass
M12 x 1.5			17	43	10	Nickel-plated brass
M14 x 1.5			17	43	10	Brass
M14 x 1.5			17	43	10	Nickel-plated brass

21SBI Plug with valve, Female Thread

Brass, NBR

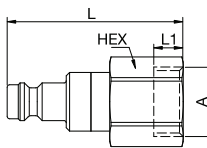

A			HEX	L	L1	Version
G1/8			14	40	7	Brass
G1/8			14	40	7	Nickel-plated brass
G1/4			17	42	7	Brass
G1/4			17	42	7	Nickel-plated brass
G3/8			19	42	7	Brass
G3/8			19	42	7	Nickel-plated brass
M12 x 1.5			17	42	7	Brass
M12 x 1.5			17	42	7	Nickel-plated brass
M14 x 1.5			17	42	7	Brass
M14 x 1.5			17	42	7	Nickel-plated brass

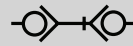

Double Shut-off

21SBTF Plug with valve, Hose Barb

Brass, NBR

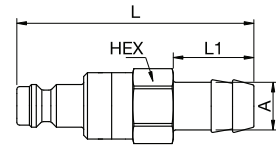

A			HEX	L	L1	Version
4			14	50	17	Brass
4			14	50	17	Nickel-plated brass
5			14	50	17	Brass
5			14	50	17	Nickel-plated brass
6			14	50	17	Brass
6			14	50	17	Nickel-plated brass
8			14	50	17	Brass
8			14	50	17	Nickel-plated brass
9			14	50	17	Brass
9			14	50	17	Nickel-plated brass
10			14	50	17	Brass
10			14	50	17	Nickel-plated brass

21SBKO Plug with valve, with Plastic Hose Connection

Brass, NBR

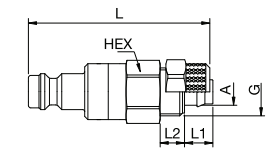

A			HEX	G	L	L1	L2	Version
4 x 6			14	M10x1	46	7	6	Brass
4 x 6			14	M10x1	46	7	6	Nickel-plated brass
6 x 8			14	M12x1	46	7	6	Brass
6 x 8			14	M12x1	46	7	6	Nickel-plated brass

21SBKS Plug with valve, Panel Mount with Plastic Hose Connection

Brass, NBR

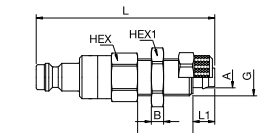

A			HEX	HEX1	B	G	L	L1	L2	Version
4 x 6			14	12	3	M10x1	58	7	18	Brass
4 x 6			14	12	3	M10x1	58	7	18	Nickel-plated brass
6 x 8			17	17	4	M12x1	58	7	18	Brass
6 x 8			17	17	4	M12x1	58	7	18	Nickel-plated brass

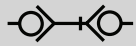

Double Shut-off

21SBTS Plug with valve, Panel Mount with Hose Barb

Brass, NBR

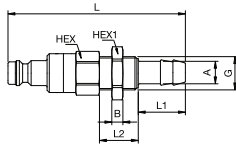

A		HEX	HEX1	B	G	L	L1	L2	Version
4	21SBTS04MPX	14	14	3	M10x1	64	17	14	Brass
4	21SBTS04MPN	14	14	3	M10x1	64	17	14	Nickel-plated brass
5	21SBTS05MPX	14	14	4	M10x1	64	17	14	Brass
5	21SBTS05MPN	14	14	4	M10x1	64	17	14	Nickel-plated brass
6	21SBTS06MPX	14	17	4	M12x1	64	17	14	Brass
6	21SBTS06MPN	14	17	4	M12x1	64	17	14	Nickel-plated brass
8	21SBTS08MPX	14	17	4	M12x1	64	17	14	Brass
8	21SBTS08MPN	14	17	4	M12x1	64	17	14	Nickel-plated brass
9	21SBTS09MPX	14	17	4	M12x1	64	17	14	Brass
9	21SBTS09MPN	14	17	4	M12x1	64	17	14	Nickel-plated brass
10	21SBTS10MPX	14	19	4	M14x1	64	17	14	Brass
10	21SBTS10MPN	14	19	4	M14x1	64	17	14	Nickel-plated brass

21SBKK Plug with valve, Plastic Hose Connection with Spring Guard

Brass, NBR

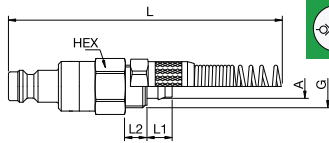

A		HEX	G	L	L1	L2	Version
4 x 6	21SBKK06MPX	14	M10x1	130	7	6	Brass
4 x 6	21SBKK06MPN	14	M10x1	130	7	6	Nickel-plated brass
6 x 8	21SBKK08MPX	14	M12x1	135	7	6	Brass
6 x 8	21SBKK08MPN	14	M12x1	135	7	6	Nickel-plated brass

21SBRP Plug with valve, Push-In

Nickel-plated brass, NBR

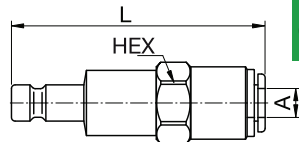

A		HEX	L
4 x 6	21SBRP06MPN	14	47.5
6 x 8	21SBRP08MPN	17	47.5



Dry-Break

21KLAW Coupler with valve, Male Thread

Nickel-plated brass, NBR

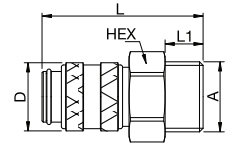

A		HEX	L	L1	D
G1/8	21KLAW10MPN	14	36	7	16
G1/4	21KLAW13MPN	17	38	9	16
G3/8	21KLAW17MPN	19	38	9	16

21KLIW Coupler with valve, Female Thread

Nickel-plated brass, NBR

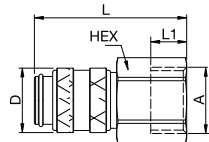

A		HEX	L	L1	D
G1/8	21KLIW10MPN	14	36	9	16
G1/4	21KLIW13MPN	17	38	9	16
G3/8	21KLIW17MPN	19	38	9	16

21KLTF Coupler with valve, Hose Barb

Nickel-plated brass, NBR

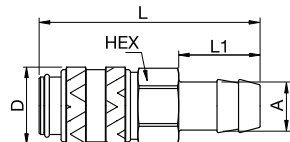

A		HEX	L	L1	D
4	21KLTF04MPN	14	46	17	16
6	21KLTF06MPN	14	46	17	16
8	21KLTF08MPN	14	46	17	16
9	21KLTF09MPN	14	46	17	16
10	21KLTF10MPN	14	46	17	16

21KLKO Coupler with valve, with Plastic Hose Connection

Nickel-plated brass, NBR

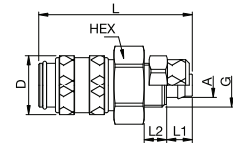

A		HEX	G	L	L1	L2	D
4 x 6	21KLKO06MPN	14	M10x1	42	7	6	16
6 x 8	21KLKO08MPN	14	M12x1	42	7	6	16



Dry-Break

21KLKS Coupler with valve, Panel Mount with Plastic Hose Connection

Nickel-plated brass, NBR

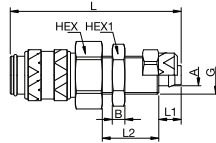
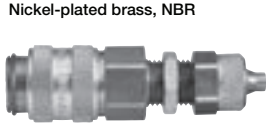

A	HEX	HEX1	B	G	L	L1	L2	D	
4 x 6	21KLKS06MPN	14	14	3	M10x1	54	7	18	16
6 x 8	21KLKS08MPN	17	17	4	M12x1	54	7	18	16

21KLTS Coupler with valve, Panel Mount with Hose Barb

Nickel-plated brass, NBR

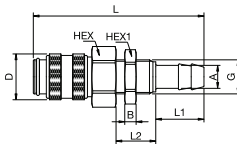

A	HEX	HEX1	B	G	L	L1	L2	D	
5	21KLTS05MPN	17	17	4	M12x1	60	17	14	16
6	21KLTS06MPN	17	17	4	M12x1	60	17	14	16

21KLKK Coupler with valve, Plastic Hose Connection with Spring Guard

Nickel-plated brass, NBR

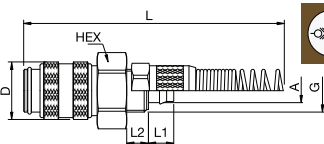

A	HEX	G	L	L1	L2	D	
4 x 6	21KLKK06MPN	14	M10x1	125	7	6	16
6 x 8	21KLKK08MPN	14	M10x1	130	7	6	16

21SLAW Plug with valve, Male Thread

Nickel-plated brass, NBR

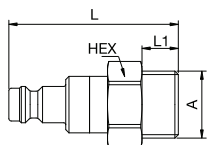

A	HEX	L	L1	
G1/8	21SLAW10MPN	14	40	7
G1/4	21SLAW13MPN	17	42	9
G3/8	21SLAW17MPN	19	42	9



Dry-Break

21SLIW Plug with valve, Female Thread

Nickel-plated brass, NBR

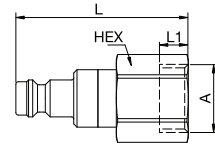
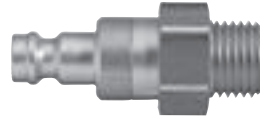

A	HEX	L	L1	
G1/8	21SLIW10MPN	14	40	7
G1/4	21SLIW13MPN	17	42	7
G3/8	21SLIW17MPN	19	42	7

21SLTF Plug with valve, Hose Barb

Nickel-plated brass, NBR

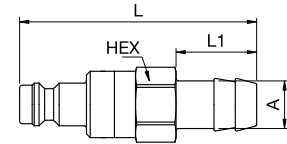

A	HEX	L	L1	
4	21SLTF04MPN	14	50	17
6	21SLTF06MPN	14	50	17
8	21SLTF08MPN	14	50	17
9	21SLTF09MPN	14	50	17
10	21SLTF10MPN	14	50	17

21SLKO Plug with valve, with Plastic Hose Connection

Nickel-plated brass, NBR

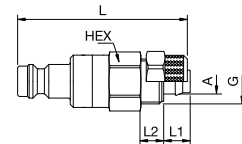

A	HEX	G	L	L1	L2	
4 x 6	21SLKO06MPN	14	M10x1	46	7	6
6 x 8	21SLKO08MPN	14	M12x1	46	7	6

21SLKS Plug with valve, Panel Mount with Plastic Hose Connection

Nickel-plated brass, NBR

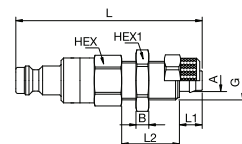

A	HEX	HEX1	B	G	L	L1	L2	
4 x 6	21SLKS06MPN	14	12	3	M10x1	58	7	18
6 x 8	21SLKS08MPN	14	17	4	M12x1	58	7	18



Dry-Break

21SLTS Plug with valve, Panel Mount with Hose Barb

Nickel-plated brass, NBR

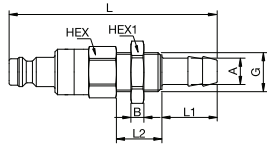

A		HEX	HEX1	B	G	L	L1	L2
5	21SLTS05MPN	14	14	4	M12x1	64	17	14
6	21SLTS06MPN	14	17	4	M12x1	64	17	14

21SLKK Plug with valve, Plastic Hose Connection with Spring Guard

Nickel-plated brass, NBR

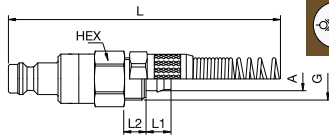

A		HEX	G	L	L1	L2
4 x 6	21SLKK06MPN	14	M10x1	130	7	6
6 x 8	21SLKK08MPN	14	M12x1	135	7	6



Robust brass coupling with numerous connection options. Preferred application is the compressed air technology. Also particularly suited to use with water due to the brass valve. Coupling system with single-hand operation. Plug design optimised through greater insert depth.

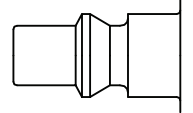

ARO Profile

- Available on request:
 - in brass material with nickel plating
 - with additional end connections
 - other seals for different temperature ranges and fluids

KA
Single Shut-Off

Working Pressure*:
up to 35 bar

Material:

- Coupling: Brass
- Plug: Brass
- Seals: NBR

Working Temperature:
-20°C up to +100°C (NBR)

Flow Rate Air:
660 l/min.
inlet pressure 6 bar, pressure drop 0.5 bar

Flow Rate Water:
9.1 l/min.
pressure drop 0.5 bar

* maximum static working pressure with design factor 4 to 1.

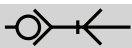

Single Shut-Off

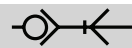

Single Shut-Off

14KAAW Coupler with valve, Male Thread

Brass, NBR

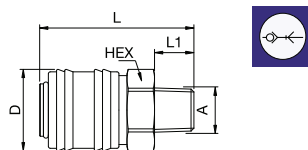

A	HEX	L	L1	D
G1/4 14KAAW13MPX	22	43	9	25
G3/8 14KAAW17MPX	22	43	9	25
G1/2 14KAAW21MPX	22	46	12	25

14KATF Coupler with valve, Hose Barb

Brass, NBR

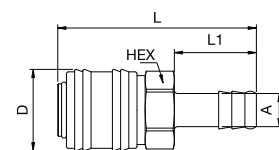
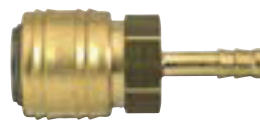

A	HEX	L	L1	D
6 14KATF06MPX	21	60	25	25
8 14KATF08MPX	21	60	25	25
9 14KATF09MPX	21	60	25	25
10 14KATF10MPX	21	60	25	25
13 14KATF13MPX	21	60	25	25

14KAIW Coupler with valve, Female Thread

Brass, NBR

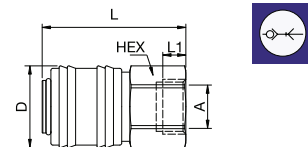

A	HEX	L	L1	D
G1/4 14KAIW13MPX	22	43	9	25
G3/8 14KAIW17MPX	22	43	9	25
G1/2 14KAIW21MPX	24	46	12	25



Single Shut-Off

22SFA Plug without valve, Male Thread

Nickel-plated steel or brass

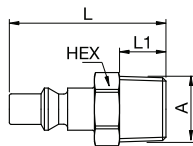

A			HEX	L	L1	Version
R1/8			12	35	9	Nickel-plated steel
R1/4			14	41	12	Nickel-plated steel
R1/4			14	41	12	Brass
G1/4			14	41	12	Brass
R3/8			17	41	12	Nickel-plated steel
G3/8			17	41	12	Brass
R1/2			22	46	17	Nickel-plated steel
G1/2			22	46	17	Brass

22SFIW Plug without valve, Female Thread

Nickel-plated steel or brass

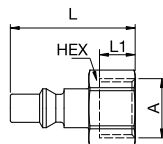

A			HEX	L	L1	Version
G1/4			17	35	9	Nickel-plated steel
G1/4			17	35	9	Brass
G3/8			19	35	10	Nickel-plated steel
G1/2			24	35	12	Nickel-plated steel

22SFTF Plug without valve, Hose Barb

Nickel-plated steel or brass

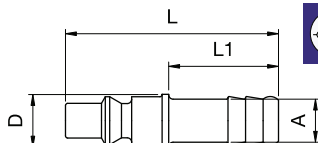

A			L	L1	D	Version
6			49	25	12	Nickel-plated steel
6			49	25	12	Brass
8			49	25	12	Nickel-plated steel
9			49	25	12	Nickel-plated steel
10			49	25	12	Nickel-plated steel
10			49	25	12	Brass
13			49	25	15	Nickel-plated steel



Robust industrial coupling according to ISO 6150 C. Coupling system with single-hand operation. High Flow valve for optimum flow and low pressure drop. The steel sleeve counters oscillating forces. System has limited use for liquids (steel sleeve/zinc die cast valve). The high insertion depth guarantees by an optimised plug guidance.

- Available on request:
 - with additional end connections
 - other seals for different temperature ranges and fluids

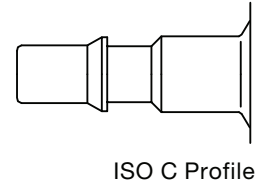

Dust Protections (P. 357)
for Coupling Part.-No. SK23S

KA
Single Shut-Off

Working Pressure*:
up to 35 bar

Material:

- Coupling: Nickel plated brass / steel
- Plug: Nickel plated steel
- Seals: NBR

Working Temperature:
-20°C up to +100°C (NBR)

Flow Rate Air:
970 l/min.
inlet pressure 6 bar, pressure drop 0.5 bar

Flow Rate Water:
12.7 l/min.
pressure drop 0.5 bar

* maximum static working pressure with design factor 4 to 1.

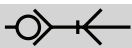

Single Shut-Off

18KAAK Coupler with valve, Male Thread

Nickel-plated brass/steel, NBR

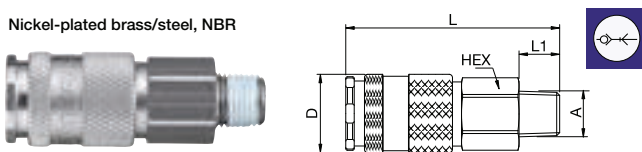

A		HEX	L	L1	D
R1/4	18KAAK13MPN	19	63	12	23
R3/8	18KAAK17MPN	19	62	12	23
R1/2	18KAAK21MPN	22	63	17	23

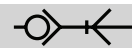

Single Shut-Off

18KATF Coupler with valve, Hose Barb

Nickel-plated brass/steel, NBR

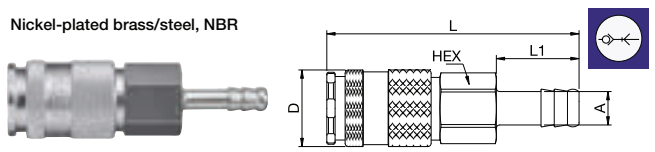

A			HEX	L	L1	D
6	18KATF06MPN	9123 18 06	19	76	25	23
8	18KATF08MPN	9123 18 08	19	76	25	23
10	18KATF10MPN	9123 18 10	19	76	25	23
13	18KATF13MPN		19	76	25	23

18KAIW Coupler with valve, Female Thread

Nickel-plated brass/steel, NBR

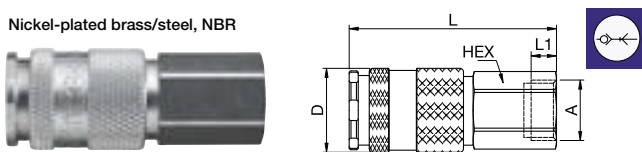

A			HEX	L	L1	D
G1/4	18KAIW13MPN	9114 18 13	19	58	9	23
G3/8	18KAIW17MPN	9114 18 17	19	57	9	23
G1/2	18KAIW21MPN		24	60	12	23

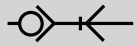

Single Shut-Off

18SFAW Plug without valve, Male Thread

Nickel-plated steel

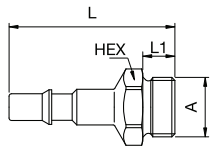

A			HEX	L	L1
G1/4	18SFAW13SXN	9087 18 13	17	41	9
G3/8	18SFAW17SXN	9087 18 17	19	41	9

18SFIW Plug without valve, Female Thread

Nickel-plated steel

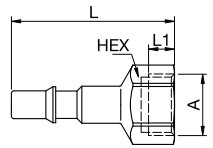

A			HEX	L	L1
G1/4	18SFIW13SXN	9086 18 13	17	43	9
G3/8	18SFIW17SXN	9086 18 17	19	44	9

18SFTF Plug without valve, Hose Barb

Nickel-plated steel

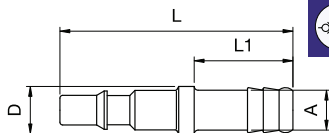

A			L	L1	D
6	18SFTF06SXN	9085 18 06	59	25	12
8	18SFTF08SXN	9085 18 08	59	25	12
10	18SFTF10SXN	9085 18 10	59	25	12



British industrial profile. Coupling system with single-hand operation. High Flow valve for optimum flow and low pressure drop. Robust coupling in slim design mainly for pneumatic applications. The steel sleeve counters oscillating forces. The high insertion depth guarantees by an optimised plug guidance.

- Available on request:
 - with additional end connections
 - other seals for different temperature ranges and fluids

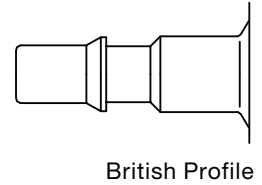

Dust Protections (P. 357)
for Coupling Part.-No. SK23S

KA Single Shut-Off

Working Pressure*:
up to 35 bar

Material:

- Coupling: Nickel plated brass / steel
- Plug: Nickel plated steel
- Seals: NBR

Working Temperature:
-20°C up to +100°C (NBR)

Flow Rate Air:
850 l/min.
inlet pressure 6 bar, pressure drop 0.5 bar

Flow Rate Water:
12 l/min.
pressure drop 0.5 bar

* maximum static working pressure with design factor 4 to 1.

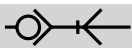

Single Shut-Off

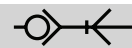

Single Shut-Off

19KAAK Coupler with valve, Male Thread

Nickel-plated brass/steel, NBR

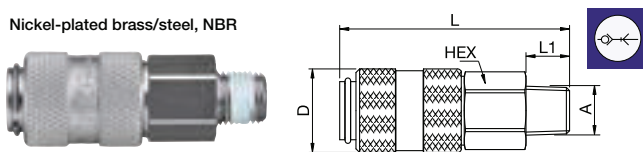

A			HEX	L	L1	D
R1/4	19KAAK13MPN	9105 19 13	19	63	12	23
R3/8	19KAAK17MPN	9105 19 17	19	62	12	23
R1/2	19KAAK21MPN		22	68	17	23

19KATF Coupler with valve, Hose Barb

Nickel-plated brass/steel, NBR

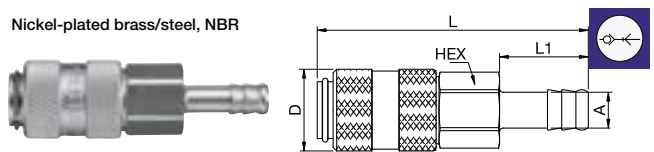

A			HEX	L	L1	D
6	19KATF06MPN	9123 19 06	19	76	25	23
8	19KATF08MPN		19	76	25	23
10	19KATF10MPN		19	76	25	23
13	19KATF13MPN		19	76	25	23

19KAIW Coupler with valve, Female Thread

Nickel-plated brass/steel, NBR

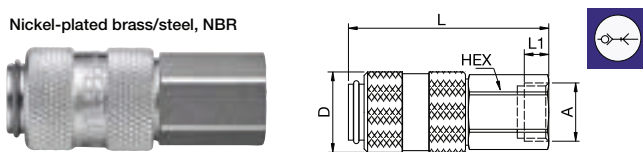

A			HEX	L	L1	D
G1/4	19KAIW13MPN	9114 19 13	19	58	9	23
G3/8	19KAIW17MPN		19	58	9	23
G1/2	19KAIW21MPN		24	60	12	23

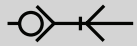

Single Shut-Off

19SFAK Plug without valve, Male Thread

Nickel-plated steel

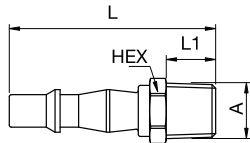

A



HEX L L1

R1/4	19SFAK13SXN	9084 19 13	14	50	12
R3/8	19SFAK17SXN		17	50	12

19SFIW Plug without valve, Female Thread

Nickel-plated steel

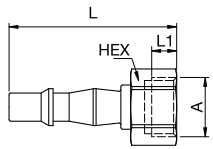

A



HEX L L1

G1/4	19SFIW13SXN		17	46	9
G3/8	19SFIW17SXN		19	47	9

19SFTF Plug without valve, Hose Barb

Nickel-plated steel

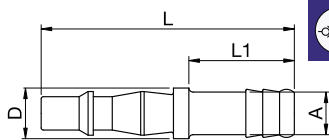

A



L L1 D

6	19SFTF06SXN		60	25	12
8	19SFTF08SXN		60	25	12
10	19SFTF10SXN	9085 19 10	60	25	12



Coupling system with single-hand operation. High Flow valve for optimum flow and low pressure drop. Specially suited to use with gaseous media in industry. The steel sleeve counters oscillating forces. The high insertion depth guarantees by an optimised plug guidance.

- Available on request:
 - with additional end connections
 - other seals for different temperature ranges and fluids

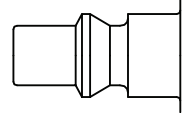

ARO Profile

Dust Protections (P. 357)
for Coupling Part.-No. SK23S

KA Single Shut-Off

Working Pressure*:
up to 35 bar

Material:

- Coupling: Nickel plated brass / steel
- Plug: Nickel plated steel or brass
- Seals: NBR

Working Temperature:
-20°C up to +100°C (NBR)

Flow Rate Air:
800 l/min.
inlet pressure 6 bar, pressure drop 0.5 bar

Flow Rate Water:
15 l/min.
pressure drop 0.5 bar

* maximum static working pressure with design factor 4 to 1.

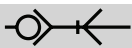

Single Shut-Off

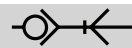

Single Shut-Off

22KAAK Coupler with valve, Male Thread

Nickel-plated brass/steel, NBR

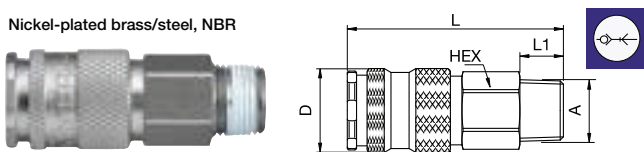

A			HEX	L	L1	D
R1/4	22KAAK13MPN	9105 22 13	19	61	12	23
R3/8	22KAAK17MPN	9105 22 17	19	60	12	23
R1/2	22KAAK21MPN	9105 22 21	22	61	17	23

22KATF Coupler with valve, Hose Barb

Nickel-plated brass/steel, NBR

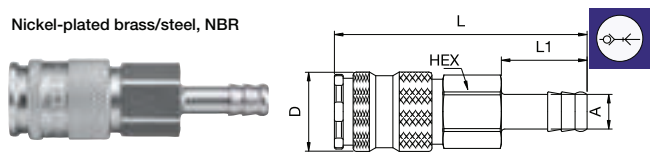

A			HEX	L	L1	D
6	22KATF06MPN		19	74	25	23
8	22KATF08MPN	9123 22 08	19	74	25	23
9	22KATF09MPN		19	74	25	23
10	22KATF10MPN	9123 22 10	19	74	25	23
13	22KATF13MPN		19	74	25	23

22KAIW Coupler with valve, Female Thread

Nickel-plated brass/steel, NBR

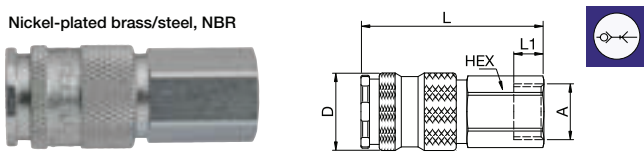

A			HEX	L	L1	D
G1/4	22KAIW13MPN	9114 22 13	19	56	9	23
G3/8	22KAIW17MPN	9114 22 17	19	55	9	23
G1/2	22KAIW21MPN	9114 22 21	24	58	9	23



Single Shut-Off

22SFA Plug without valve, Male Thread

Nickel-plated steel or brass

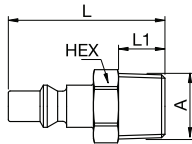

A			HEX	L	L1	Version
R1/8	22SFAK10SXN		12	35	9	Nickel-plated steel
R1/4	22SFAK13SXN	9084 22 13	14	41	12	Nickel-plated steel
R1/4	22SFAK13MXX		14	41	12	Brass
G1/4	22SFAW13MXX		14	41	12	Brass
R3/8	22SFAK17SXN	9084 22 17	17	41	12	Nickel-plated steel
G3/8	22SFAW17MXX		17	41	12	Brass
R1/2	22SFAK21SXN	9084 22 21	22	46	17	Nickel-plated steel
G1/2	22SFAW21MXX		22	46	17	Brass

22SFIW Plug without valve, Female Thread

Nickel-plated steel or brass

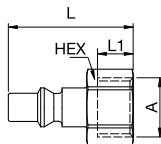

A			HEX	L	L1	Version
G1/4	22SFIW13SXN	9086 22 13	17	35	9	Nickel-plated steel
G1/4	22SFIW13MXX		17	35	9	Brass
G3/8	22SFIW17SXN	9086 22 17	19	35	10	Nickel-plated steel
G1/2	22SFIW21SXN	9086 22 21	24	35	12	Nickel-plated steel

22SFTF Plug without valve, Hose Barb

Nickel-plated steel or brass

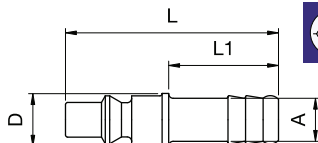

A			L	L1	D	Version
6	22SFTF06SXN	9085 22 06	49	25	12	Nickel-plated steel
6	22SFTF06MXX		49	25	12	Brass
8	22SFTF08SXN	9085 22 08	49	25	12	Nickel-plated steel
9	22SFTF09SXN	9085 22 09	49	25	12	Nickel-plated steel
10	22SFTF10SXN	9085 22 10	49	25	12	Nickel-plated steel
10	22SFTF10MXX		49	25	12	Brass
13	22SFTF13SXN	9085 22 13	49	25	15	Nickel-plated steel



1/4" Industrial brass coupling according to ISO 6150 B and US MIL-SPEC 4109. Coupling system with single-hand operation, which stands out for its solid brass design and corresponding sleeve design. Hardened steel plug counters vibrations and effects of external forces.

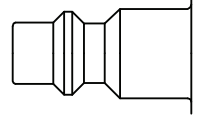

ISO B Profile

- Available on request:
 - with additional end connections
 - other seals for different temperature ranges and fluids

KA
Single Shut-Off

Working Pressure*:
up to 35 bar

Material:

- Coupling: Brass
- Plug: Nickel plated steel or brass
- Seals: NBR

Working Temperature:
-20°C up to +100°C (NBR)

Flow Rate Air:
820 l/min.
inlet pressure 6 bar, pressure drop 0.5 bar

Flow Rate Water:
7.4 l/min.
pressure drop 0.5 bar

* maximum static working pressure with design factor 4 to 1.

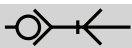

Single Shut-Off

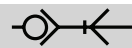

Single Shut-Off

24KAAW Coupler with valve, Male Thread

Brass, NBR

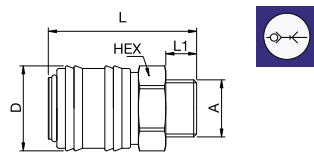

A			HEX	L	L1	D	Version
G1/4			22	43	9	25	Brass
G1/4			22	43	9	25	Nickel-plated brass
G3/8			22	43	9	25	Brass
G3/8			22	43	9	25	Nickel-plated brass
G1/2			22	46	12	25	Brass
G1/2			22	46	12	25	Nickel-plated brass

24KAIW Coupler with valve, Female Thread

Brass, NBR

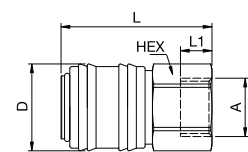

A			HEX	L	L1	D	Version
G1/4			22	43	11	25	Brass
G1/4			22	43	11	25	Nickel-plated brass
G3/8			22	43	9	25	Brass
G3/8			22	43	9	25	Nickel-plated brass
G1/2			22	46	12	25	Brass
G1/2			22	46	12	25	Nickel-plated brass

Series 24 - Brass/Steel

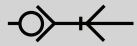

Single Shut-Off

24KATF Coupler with valve, Hose Barb

Brass, NBR

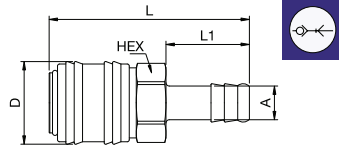

A			HEX	L	L1	D	Version
6							Brass
6							Nickel-plated brass
8							Brass
8							Nickel-plated brass
9							Brass
9							Nickel-plated brass
10							Brass
10							Nickel-plated brass
13							Brass
13							Nickel-plated brass

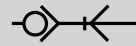

Single Shut-Off

23SFTF Plug without valve, Hose Barb

Nickel-plated steel or brass

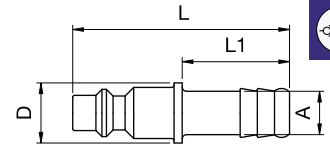

A			L	L1	D	Version
6						Nickel-plated steel
6						Brass
8						Nickel-plated steel
9						Nickel-plated steel
9						Brass
10						Nickel-plated steel
13						Nickel-plated steel

23SFA Plug without valve, Male Thread

Nickel-plated steel or brass

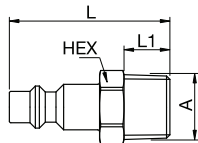

A			HEX	L	L1	Version
R1/8						Nickel-plated steel
G1/8						Nickel-plated steel
R1/4						Nickel-plated steel
G1/4						Nickel-plated steel
G1/4						Brass
R3/8						Nickel-plated steel
G3/8						Brass
G3/8						Nickel-plated steel
R1/2						Nickel-plated steel
G1/2						Nickel-plated steel

23SFIW Plug without valve, Female Thread

Nickel-plated steel

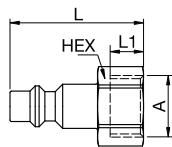

A			HEX	L	L1
G1/8					
G1/4					
G3/8					
G1/2					



1/4" Industrial coupling with UltraFlo technology in accordance with ISO 6150 B and US Mil. Spec. 4109. Especially suitable for use with gaseous media in industry. Steel sleeve counters oscillating forces. Special variants with brass valve for use with liquids. High flow performance with low pressure drop and a multitude of connection options.

- Available on request:
 - with additional end connections
 - other seals for different temperature ranges and fluids

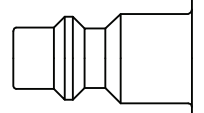

ISO B Profile

KA Single Shut-Off

Working Pressure*:
up to 35 bar

Material:

- Coupling: Nickel plated brass
- Plug: Nickel plated steel or brass
- Seals: NBR

Working Temperature:
-20°C up to +100°C (NBR)

Flow Rate Air:
960 l/min.
inlet pressure 6 bar, pressure drop 0.5 bar

Flow Rate Water:
14 l/min.
pressure drop 0.5 bar

* maximum static working pressure with design factor 4 to 1.

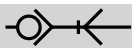

Single Shut-Off

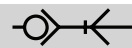

Single Shut-Off

23KAA Coupler with valve, Male Thread

Nickel-plated brass, NBR

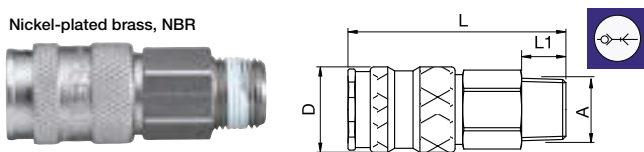

A			HEX	L	L1	D
R1/4	23KAAK13MPN		19	61	12	23
G1/4	23KAAW13MPN	9101 23 13	19	57	9	23
R3/8	23KAAK17MPN		19	60	12	23
G3/8	23KAAW17MPN	9101 23 17	19	57	9	23
R1/2	23KAAK21MPN		22	61	17	23

23KAIW Coupler with valve, Female Thread

Nickel-plated brass, NBR

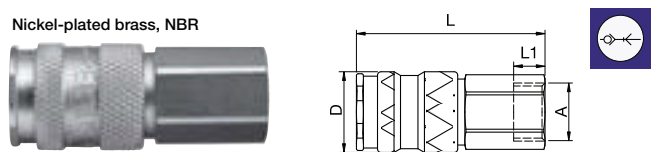

A			HEX	L	L1	D
G1/4	23KAIW13MPN	9114 23 13	19	56	9	23
G3/8	23KAIW17MPN	9114 23 17	19	54	9	23
G1/2	23KAIW21MPN	9114 23 21	24	58	9	23

Series 23 - Brass/Steel

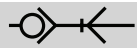

Single Shut-Off

23KATF Coupler with valve, Hose Barb

Nickel-plated brass, NBR

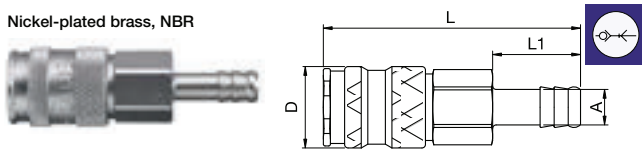

A			HEX	L	L1	D
6						
6	23KATF06MPN	9123 23 06	19	74	25	23
8	23KATF08MPN	9123 23 08	19	74	25	23
9	23KATF09MPN		19	74	25	23
10	23KATF10MPN	9123 23 10	19	74	25	23
13	23KATF13MPN		19	74	25	23

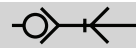

Single Shut-Off

23SFTF Plug without valve, Hose Barb

Nickel-plated steel or brass

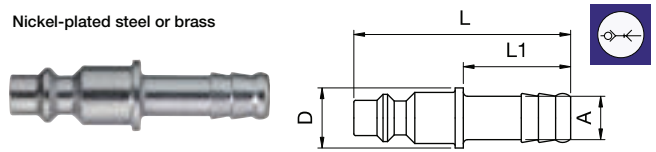

A			L	L1	D	Version
6						
6	23SFTF06SXN	9085 23 06	51	25	14	Nickel-plated steel
6	23SFTF06MXX		51	25	14	Brass
8	23SFTF08SXN	9085 23 08	51	25	14	Nickel-plated steel
9	23SFTF09SXN		51	25	14	Nickel-plated steel
9	23SFTF09MXX		51	25	14	Brass
10	23SFTF10SXN	9085 23 10	51	25	14	Nickel-plated steel
13	23SFTF13SXN		51	25	14	Nickel-plated steel

23SFA Plug without valve, Male Thread

Nickel-plated steel or brass

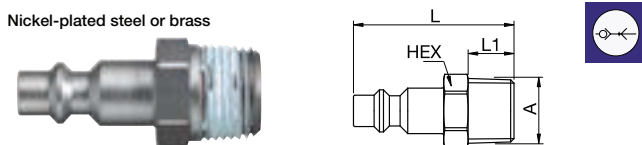

A			HEX	L	L1	Version
R1/8						
R1/8	23SFAK10SXN		13	39	9	Nickel-plated steel
G1/8	23SFAW10SXN	9087 23 10	14	35	7	Nickel-plated steel
R1/4	23SFAK13SXN		14	42	12	Nickel-plated steel
G1/4	23SFAW13SXN	9087 23 13	14	42	12	Nickel-plated steel
G1/4	23SFAW13MXX		14	42	12	Brass
R3/8	23SFAK17SXN		17	42	12	Nickel-plated steel
G3/8	23SFAW17MXX		17	42	12	Brass
G3/8	23SFAW17SXN	9087 23 17	17	42	12	Nickel-plated steel
R1/2	23SFAK21SXN		22	48	17	Nickel-plated steel
G1/2	23SFAW21SXN	9087 23 21	22	42	12	Nickel-plated steel

23SFIW Plug without valve, Female Thread

Nickel-plated steel

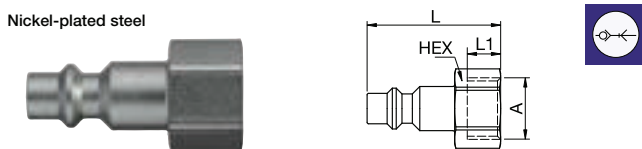

A			HEX	L	L1
G1/8					
G1/8	23SFIW10SXN	9086 23 10	14	36	9
G1/4	23SFIW13SXN	9086 23 13	17	36	9
G3/8	23SFIW17SXN	9086 23 17	19	36	9
G1/2	23SFIW21SXN	9086 23 21	24	39	12



Rectus premium industrial coupling 1/4" according to ISO 6150 B. Suitable for compressed air applications with greater than average air consumption. Coupling system with single-hand operation. Ultra High Flow valve for optimum flow and low pressure drop.

- Available on request:
 - with additional end connections
 - other seals for different temperature ranges and fluids

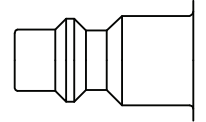

ISO B Profile

Dust Protections (P. 357)
for Coupling Part.-No. SK23S

KA Single Shut-Off

Working Pressure*:
up to 35 bar

Material:

- Coupling: Nickel plated brass, QPQ treated steel
- Plug: Nickel plated steel or brass
- Seals: NBR

Working Temperature:
-20°C up to +100°C (NBR)

Flow Rate Air:
950 l/min.
inlet pressure 6 bar, pressure drop 0.5 bar

Flow Rate Water:
13 l/min.
pressure drop 0.5 bar

* maximum static working pressure with design factor 4 to 1.

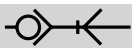

Single Shut-Off

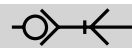

Single Shut-Off

1400KAAK Coupler with valve, Male Thread

Nickel-plated brass, Steel QPQ treated, NBR

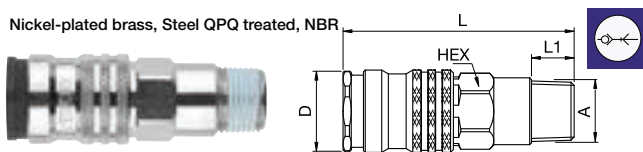

A	HEX	L	L1	D
R1/4 1400KAAK13SPN	19	65	12	23
R3/8 1400KAAK17SPN	19	65	12	23
R1/2 1400KAAK21SPN	22	59.5	17	23

1400KATF Coupler with valve, Hose Barb

Nickel-plated brass, Steel QPQ treated, NBR

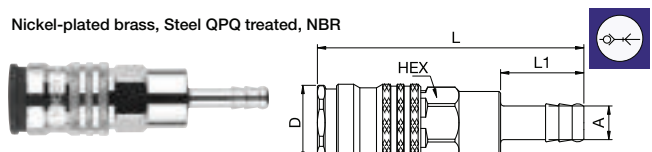

A	HEX	L	L1	D
6 1400KATF06SPN	19	80	25	23
8 1400KATF08SPN	19	80	25	23
9 1400KATF09SPN	19	80	25	23
10 1400KATF10SPN	19	80	25	23
13 1400KATF13SPN	19	80	25	23

1400KAIW Coupler with valve, Female Thread

Nickel-plated brass, Steel QPQ treated, NBR

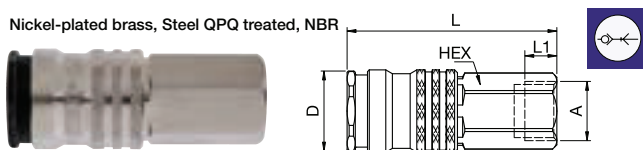

A	HEX	L	L1	D
G1/4 1400KAIW13SPN	19	59	9	23
G3/8 1400KAIW17SPN	19	59	9	23
G1/2 1400KAIW21SPN	24	62	12	23

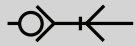



Single Shut-Off

23SFA Plug without valve, Male Thread

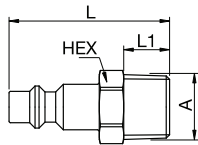
Nickel-plated steel or brass





A			HEX	L	L1	Version
R1/8	23SFAK10SXN		13	39	9	Nickel-plated steel
G1/8	23SAFW10SXN	9087 23 10	14	35	7	Nickel-plated steel
R1/4	23SFAK13SXN		14	42	12	Nickel-plated steel
G1/4	23SAFW13SXN	9087 23 13	14	42	12	Nickel-plated steel
G1/4	23SAFW13MXX		14	42	12	Brass
R3/8	23SFAK17SXN		17	42	12	Nickel-plated steel
G3/8	23SAFW17MXX		17	42	12	Brass
G3/8	23SAFW17SXN	9087 23 17	17	42	12	Nickel-plated steel
R1/2	23SFAK21SXN		22	48	17	Nickel-plated steel
G1/2	23SAFW21SXN	9087 23 21	22	42	12	Nickel-plated steel

23SFIW Plug without valve, Female Thread

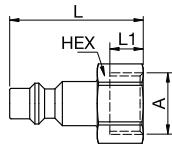
Nickel-plated steel





A			HEX	L	L1
G1/8	23SFIW10SXN	9086 23 10	14	36	9
G1/4	23SFIW13SXN	9086 23 13	17	36	9
G3/8	23SFIW17SXN	9086 23 17	19	36	9
G1/2	23SFIW21SXN	9086 23 21	24	39	12

23SFTF Plug without valve, Hose Barb

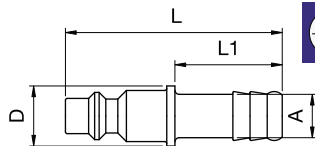
Nickel-plated steel or brass



A			L	L1	D	Version
6	23SFTF06SXN	9085 23 06	51	25	14	Nickel-plated steel
6	23SFTF06MXX		51	25	14	Brass
8	23SFTF08SXN	9085 23 08	51	25	14	Nickel-plated steel
9	23SFTF09SXN		51	25	14	Nickel-plated steel
9	23SFTF09MXX		51	25	14	Brass
10	23SFTF10SXN	9085 23 10	51	25	14	Nickel-plated steel
13	23SFTF13SXN		51	25	14	Nickel-plated steel



Coupling system with German industrial profile. Coupling system with single-hand operation. High Flow valve for optimum flow and low pressure drop.
Robust coupling in slim design mainly for pneumatic applications. The steel sleeve counters oscillating forces. The high insertion depth guarantees by an optimised plug guidance.

- Available on request:
 - with additional end connections
 - other seals for different temperature ranges and fluids

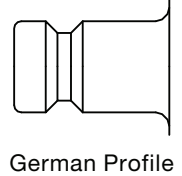

Dust Protections (P. 357)
for Coupling Part.-No. SK23S
for Plug Part.-No. SK12S

KA Single Shut-Off

Working Pressure*:
up to 50 bar

Material:

- Coupling: Nickel plated brass / steel
- Plug: Nickel plated steel
- Seals: NBR

Working Temperature:
-20°C up to +100°C (NBR)

Flow Rate Air:
1.100 l/min.
inlet pressure 6 bar, pressure drop 0.5 bar

Flow Rate Water:
14 l/min.
pressure drop 0.5 bar

KB Double Shut-Off

Working Pressure*:
up to 50 bar

Material:

- Coupling: Nickel plated brass / steel
- Plug: Nickel plated brass / steel
- Seals: NBR

Working Temperature:
-20°C up to +100°C (NBR)

Flow Rate Air:
730 l/min.
inlet pressure 6 bar, pressure drop 0.5 bar

Flow Rate Water:
10 l/min.
pressure drop 0.5 bar

* maximum static working pressure with design factor 4 to 1.

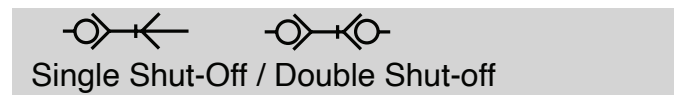
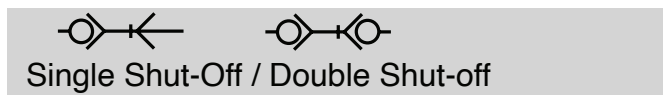

52KBAW Coupler with valve, Male Thread

Nickel-plated brass/steel, NBR

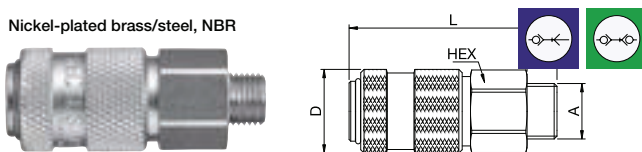

A		HEX	L	L1	D
G1/4	52KBAW13SPN	22	62	9	25
G3/8	52KBAW17SPN	22	62	9	25
G1/2	52KBAW21SPN	22	65	12	25

52KBIW Coupler with valve, Female Thread

Nickel-plated brass/steel, NBR

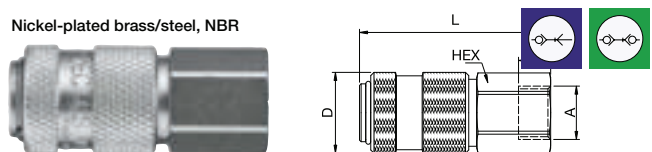

A		HEX	L	L1	D
G1/4	52KBIW13SPN	22	62	10	25
G3/8	52KBIW17SPN	22	60	10	25
G1/2	52KBIW21SPN	22	65	13	25

Series 52 - Brass/Steel



Single Shut-Off / Double Shut-off

52KBTF Coupler with valve, Hose Barb

Nickel-plated brass/steel, NBR

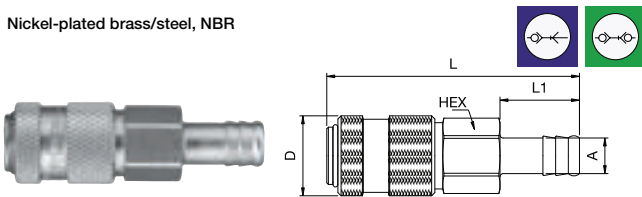

A	HEX	L	L1	D	
6	52KBTF06SPN	21	80	25	25
9	52KBTF09SPN	21	80	25	25
13	52KBTF13SPN	21	80	25	25

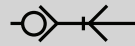

Single Shut-Off

52SFTF Plug without valve, Hose Barb

Nickel-plated steel

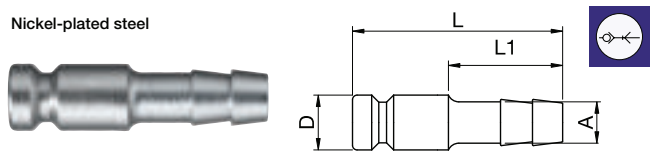

A	L	L1	D	
6	52SFTF06SXN	46	25	12
9	52SFTF09SXN	46	25	12
13	52SFTF13SXN	53	30	12

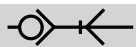

Single Shut-Off

52SFAW Plug without valve, Male Thread

Nickel-plated steel

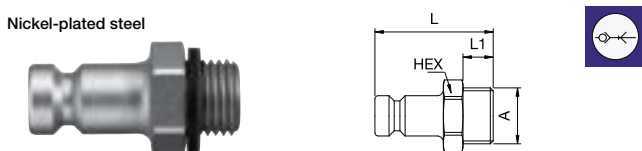

A	HEX	L	L1	
G1/4	52SFAW13SXN	17	35	9
G3/8	52SFAW17SXN	19	35	9
G1/2	52SFAW21SXN	24	38	12



Double Shut-off

52SBAW Plug with valve, Male Thread

Nickel-plated brass/steel, NBR

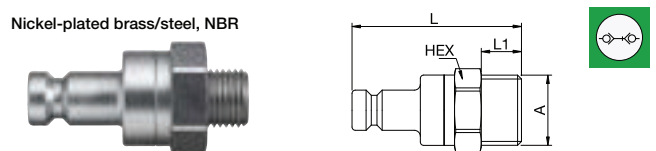

A	HEX	L	L1	
G1/4	52SBAW13SPN	22	48	9
G3/8	52SBAW17SPN	22	48	9
G1/2	52SBAW21SPN	22	48	12

52SFIW Plug without valve, Female Thread

Nickel-plated steel

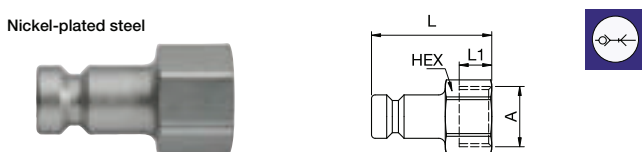

A	HEX	L	L1	
G1/4	52SFIW13SXN	17	33	9
G3/8	52SFIW17SXN	19	33	9
G1/2	52SFIW21SXN	24	36	12

52SBIW Plug with valve, Female Thread

Nickel-plated brass/steel, NBR

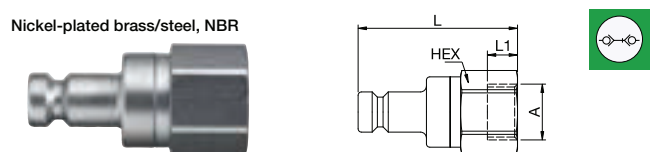

A	HEX	L	L1	
G1/4	52SBIW13SPN	22	48	9
G3/8	52SBIW17SPN	22	48	9
G1/2	52SBIW21SPN	22	51	10

52SBTF Plug with valve, Hose Barb

Nickel-plated brass/steel, NBR

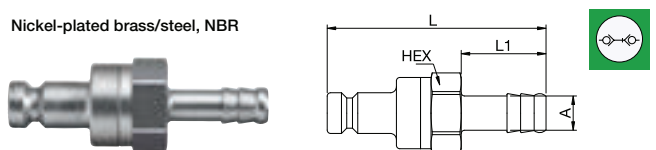

A	HEX	L	L1	
6	52SBTF06SPN	21	77.5	25
9	52SBTF09SPN	21	77.5	25
13	52SBTF13SPN	21	77.5	25



Universal brass coupling with European standard industrial profile. Coupling system with single-hand operation and standard-valve. Small mass size. The ergonomic sleeve design prevents entering dirt on the valve body. Series 26 in brass material with nickel plating and with additional end connections available on request.

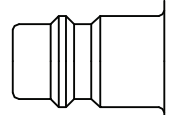

Euro Profile

- Available on request:
 - in brass material with nickel plating
 - with additional end connections
 - other seals for different temperature ranges and fluids

KA Single Shut-Off

Working Pressure*:
up to 35 bar

Material:

- Coupling: Brass
- Plug: Brass
- Seals: NBR

Working Temperature:
-20°C up to +100°C (NBR)

Flow Rate Air:
1.070 l/min.
inlet pressure 6 bar, pressure drop 0.5 bar

Flow Rate Water:
18 l/min.
pressure drop 0.5 bar

KB Double Shut-Off

Working Pressure*:
up to 35 bar

Material:

- Coupling: Brass
- Plug: Brass
- Seals: NBR

Working Temperature:
-20°C up to +100°C (NBR)

Flow Rate Air:
950 l/min.
inlet pressure 6 bar, pressure drop 0.5 bar

Flow Rate Water:
8.8 l/min.
pressure drop 0.5 bar

* maximum static working pressure with design factor 4 to 1.

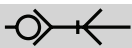

Single Shut-Off

26KAA Coupler with valve, Male Thread

Brass, NBR

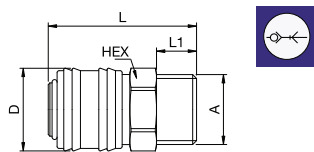

A	Version	HEX	L	L1	D	Version
G1/8	26KAAW10MPX	22	43	9	25	Brass
G1/8	26KAAW10MPN	9101 26 10	22	43	9	Nickel-plated brass
G1/4	26KAAW13MPX	22	39	9	25	Brass
G1/4	26KAAW13MPN	9101 26 13	22	39	9	Nickel-plated brass
G3/8	26KAAW17MPX	22	41	9	25	Brass
G3/8	26KAAW17MPN	9101 26 17	22	41	9	Nickel-plated brass
G1/2	26KAAW21MPX	22	44	12	25	Brass
G1/2	26KAAW21MPN	9101 26 21	22	44	12	Nickel-plated brass
G1/2	26KAAW21MPXS_36	24	44	12	25	Brass
M14 x 1.5	26KAAD14MPX	22	43	10	25	Brass
M16 x 1.5	26KAAD16MPX	22	43	11	25	Brass
M18 x 1.5	26KAAD18MPX	22	43	11	25	Brass

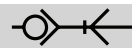

Single Shut-Off

26KAI Coupler with valve, Female Thread

Brass, NBR

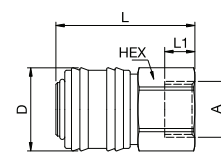

A	Version	HEX	L	L1	D	Version
G1/8	26KAIW10MPX	22	41	8	25	Brass
G1/4	26KAIW13MPX	22	41	9	25	Brass
G1/4	26KAIW13MPN	9114 26 13	22	41	9	Nickel-plated brass
G3/8	26KAIW17MPX	22	41	9	25	Brass
G3/8	26KAIW17MPN	9114 26 17	22	41	9	Nickel-plated brass
G1/2	26KAIW21MPX	24	44	10	25	Brass
G1/2	26KAIW21MPN	9114 26 21	24	44	10	Nickel-plated brass
M14 x 1.5	26KAIM14MPX	22	41	9	25	Brass
M16 x 1.5	26KAIM16MPX	22	41	9	25	Brass
M18 x 1.5	26KAIM18MPX	22	44	9	25	Brass

Series 26 - Brass/Steel



Single Shut-Off

26KAT Coupler with valve, Hose Barb

Brass, NBR

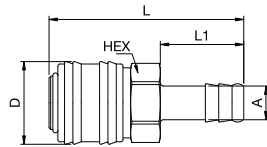
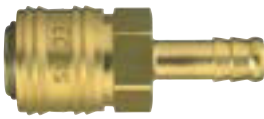

A		HEX	L	L1	D
6	26KATF06MPX	21	58	25	25
8	26KATF08MPX	21	58	25	25
9	26KATF09MPX	21	58	25	25
10	26KATF10MPX	21	58	25	25
13	26KATF13MPX	21	58	25	25
6 Push-Lok	26KATP06MPX	21	58	20.5	25
10 Push-Lok	26KATP10MPX	21	58	24	25
13 Push-Lok	26KATP13MPX	21	58	28	25

26KAKO Coupler with valve, with Plastic Hose Connection

Brass, NBR

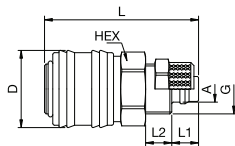

A		HEX	G	L	L1	L2	D
4 x 6	26KAKO06MPX	21	M10x1	58	7	6	25
6 x 8	26KAKO08MPX	21	M12x1	45	7	6	25
8 x 10	26KAKO10MPX	21	M16x1	49	9	8	25
9 x 12	26KAKO12MPX	21	M16x1	49	9	8	25

26KATS Coupler with valve, Panel Mount with Hose Barb

Brass, NBR

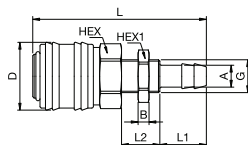
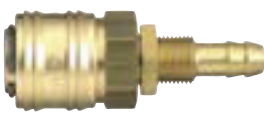

A		HEX	HEX1	B	G	L	L1	L2	D
6	26KATS06MPX	21	17	4	M12x1	60	17	10	25
10	26KATS10MPX	21	17	4	G1/4	72	25	14	25



Single Shut-Off

26KAKK Coupler with valve, Plastic Hose Connection with Spring Guard

Brass, NBR

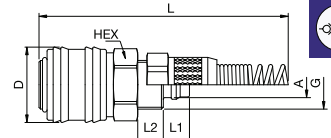

A		HEX	G	L	L1	L2	D
4 x 6	26KAKK06MPX	21	M10x1	120	7	6	25
6 x 8	26KAKK08MPX	21	M12x1	132	7	6	25
8 x 10	26KAKK10MPX	21	M16x1	143	9	8	25
9 x 12	26KAKK12MPX	21	M16x1	150	9	8	25

26SFA Plug without valve, Male Thread

Brass

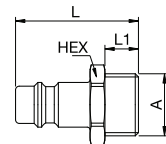

A		HEX	L	L1
G1/8	26SFAW10MXX	14	31	7
G1/4	26SFAW13MXX	17	33	9
G3/8	26SFAW17MXX	19	33	9
G1/2	26SFAW21MXX	24	38	12
M14 x 1.5	26SFAD14MXX	17	35	10
M16 x 1.5	26SFAD16MXX	19	36	11
M18 x 1.5	26SFAD18MXX	22	37	11

26SFI Plug without valve, Female Thread

Brass

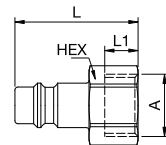

A		HEX	L	L1
G1/8	26SFIW10MXX	14	30	7
G1/4	26SFIW13MXX	17	33	10
G3/8	26SFIW17MXX	19	33	10
G1/2	26SFIW21MXX	24	35	12
M14 x 1.5	26SFIM14MXX	17	33	10
M16 x 1.5	26SFIM16MXX	19	33	10

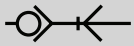

Single Shut-Off

26SFT Plug without valve, Hose Barb

Brass

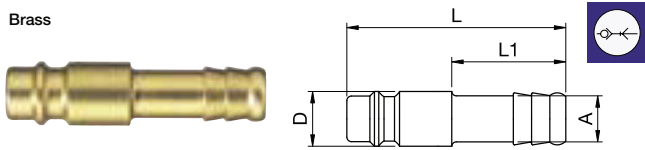

A		L	L1	D
4	26SFTF04MXX	48	25	12
6	26SFTF06MXX	48	25	12
8	26SFTF08MXX	48	25	12
9	26SFTF09MXX	48	25	12
10	26SFTF10MXX	48	25	12
13	26SFTF13MXX	48	25	15
6 Push-Lok	26SFTP06MXX	43	20.5	16
10 Push-Lok	26SFTP10MXX	46	24	22
13 Push-Lok	26SFTP13MXX	50	28	24

26FKO Plug without valve, with Plastic Hose Connection

Brass

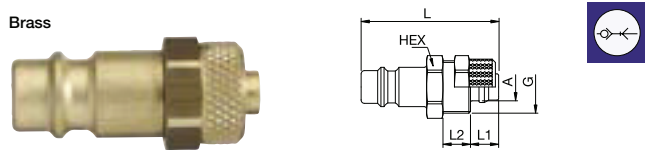

A		HEX	G	L	L1	L2	D
4 x 6	26SFKO06MXX		M10x1	34	7	6	12
6 x 8	26SFKO08MXX		M12x1	34	7	6	12
8 x 10	26SFKO10MXX	17	M16x1	42	9	6	
9 x 12	26SFKO12MXX	17	M16x1	42	9	8	

26SFTS Plug without valve, Panel Mount with Hose Barb

Brass

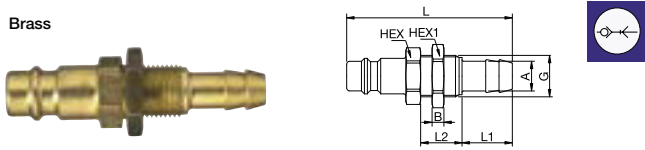

A		HEX	HEX1	B	G	L	L1	L2
10	26SFTS10MXX	17	19	4	M14x1	56	17	14

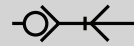

Single Shut-Off

26SFKK Plug without valve, Plastic Hose Connection with Spring Guard

Brass

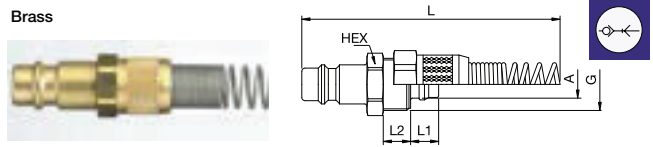

A		HEX	G	L	L1	L2	D
4 x 6	26SFKK06MXX		M10x1	120	7	6	12
6 x 8	26SFKK08MXX		M12x1	127	7	6	12
8 x 10	26SFKK10MXX	17	M16x1	135	9	8	
9 x 12	26SFKK12MXX	17	M16x1	142	9	8	

26SRTF Plug without valve, Recoil Eliminator with Hose Barb

Brass

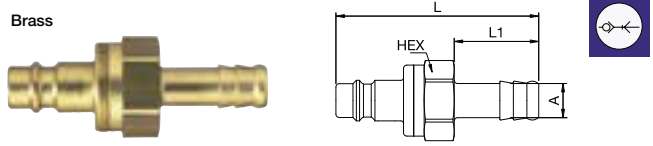

A		HEX	L	L1
6	26SRTF06MXX	21	60	25
8	26SRTF08MXX	21	60	25
9	26SRTF09MXX	21	60	25
10	26SRTF10MXX	21	60	25
13	26SRTF13MXX	21	60	25



Double Shut-off

26KBA Coupler with valve, Male Thread

Brass, NBR

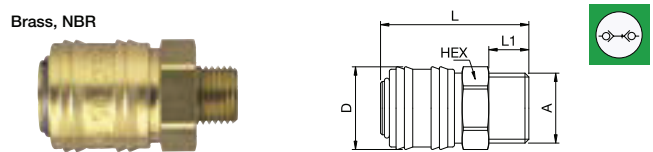

A		HEX	L	L1	D
G1/8	26KBAW10MPX	22	43	9	25
G1/4	26KBAW13MPX	22	39	9	25
G3/8	26KBAW17MPX	22	41	9	25
G1/2	26KBAW21MPX	24	44	10	25
M14 x 1.5	26KBAD14MPX	22	43	10	25
M16 x 1.5	26KBAD16MPX	22	43	11	25
M18 x 1.5	26KBAD18MPX	22	43	11	25

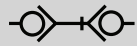

Double Shut-off

26KBI Coupler with valve, Female Thread

Brass, NBR

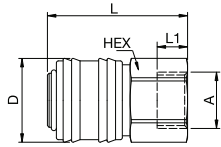

A		HEX	L	L1	D
G1/8	26KBIW10MPX	22	41	8	25
G1/4	26KBIW13MPX	22	41	9	25
G3/8	26KBIW17MPX	22	41	9	25
G1/2	26KBIW21MPX	24	44	10	25
M14 x 1.5	26KBIM14MPX	22	41	9	25
M16 x 1.5	26KBIM16MPX	22	41	9	25
M18 x 1.5	26KBIM18MPX	22	41	9	25

26KBT Coupler with valve, Hose Barb

Brass, NBR

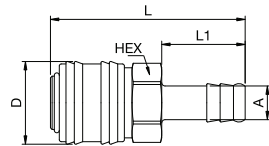
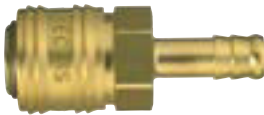

A		HEX	L	L1	D
6	26KBTf06MPX	21	58	25	25
8	26KBTf08MPX	21	58	25	25
9	26KBTf09MPX	21	58	25	25
10	26KBTf10MPX	21	58	25	25
13	26KBTf13MPX	21	58	25	25
6 Push-Lok	26KBTp06MPX	21	58	20.5	25
10 Push-Lok	26KBTp10MPX	21	58	24	25
13 Push-Lok	26KBTp13MPX	21	58	28	25

26KBK0 Coupler with valve, with Plastic Hose Connection

Brass, NBR

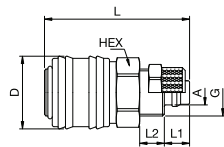

A		HEX	G	L	L1	L2	D
4 x 6	26KBK006MPX	21	M10x1	45	7	6	25
6 x 8	26KBK008MPX	21	M12x1	45	7	6	25
8 x 10	26KBK010MPX	21	M16x1	49	9	8	25
9 x 12	26KBK012MPX	21	M16x1	49	9	8	25

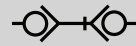

Double Shut-off

26KBTs Coupler with valve, Panel Mount with Hose Barb

Brass, NBR

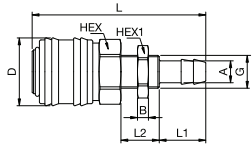
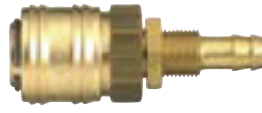

A		HEX	HEX1	B	G	L	L1	L2	D
6	26KBTs06MPX	21	17	4	M12x1	60	17	10	25
10	26KBTs10MPX	21	17	4	G1/4	72	25	14	25

26KBKK Coupler with valve, Plastic Hose Connection with Spring Guard

Brass, NBR

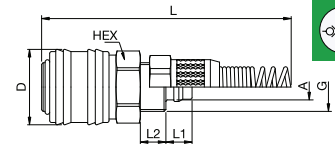

A		HEX	G	L	L1	L2	D
6 x 8	26KBKK08MPX	21	M12x1	132	7	6	25
8 x 10	26KBKK10MPX	21	M16x1	143	9	8	25
9 x 12	26KBKK12MPX	21	M16x1	150	9	8	25

Plugs for Series 26KB can be found with Series 25, on pages 247.



Robust brass coupling with Japanese industrial profile. Coupling system with single-hand operation. Above average flow volumes and structure resistant to the effects of external forces.

- Available on request:
 - in brass material with nickel plating
 - with additional end connections
 - other seals for different temperature ranges and fluids

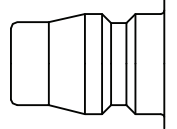

Japanese Profile

KA
Single Shut-Off

Working Pressure*:
up to 35 bar

Material:

- Coupling: Brass
- Plug: Nickel plated steel
- Seals: NBR

Working Temperature:
-20°C up to +100°C (NBR)

Flow Rate Air:
1.150 l/min.
inlet pressure 6 bar, pressure drop 0.5 bar

Flow Rate Water:
16 l/min.
pressure drop 0.5 bar

* maximum static working pressure with design factor 4 to 1.

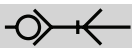

Single Shut-Off

13KAAK Coupler with valve, Male Thread

Brass, NBR

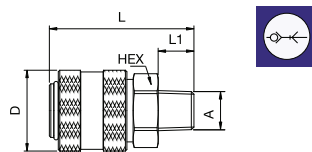

A	HEX	L	L1	D
R1/4 13KAAK13MPX	22	49	12	27
R3/8 13KAAK17MPX	22	49	12	27
R1/2 13KAAK21MPX	22	53	17	27

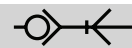

Single Shut-Off

13KATF Coupler with valve, Hose Barb

Brass, NBR

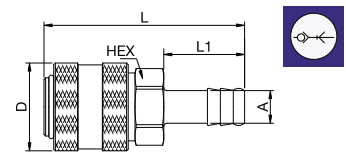
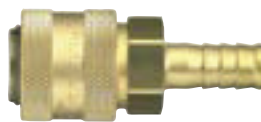

A	HEX	L	L1	D
6 13KATF06MPX	21	62	25	27
8 13KATF08MPX	21	62	25	27
10 13KATF10MPX	21	62	25	27
13 13KATF13MPX	21	62	25	27

13KAIW Coupler with valve, Female Thread

Brass, NBR

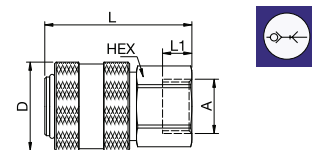

A	HEX	L	L1	D
G1/4 13KAIW13MPX	22	45	9	27
G3/8 13KAIW17MPX	22	45	9	27
G1/2 13KAIW21MPX	24	48	12	27

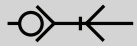

Single Shut-Off

13SFAK Plug without valve, Male Thread

Nickel-plated steel

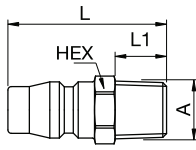

A		HEX	L	L1
R1/4	13SFAK13SXN	14	37	12
R3/8	13SFAK17SXN	17	37	12
R1/2	13SFAK21SXN	22	44	17

13SFIW Plug without valve, Female Thread

Nickel-plated steel

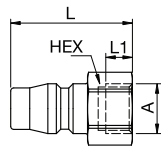

A			HEX	L	L1
G1/4	13SFIW13SXN	9086 13 13	17	34	9
G3/8	13SFIW17SXN		19	34	9
G1/2	13SFIW21SXN		24	35	10

13SFTF Plug without valve, Hose Barb

Nickel-plated steel

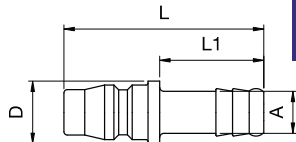

A			L	L1	D
6	13SFTF06SXN		48	25	15
8	13SFTF08SXN		48	25	15
10	13SFTF10SXN		48	25	15
13	13SFTF13SXN	9085 13 13	48	25	15



Universal industrial coupling with standard European profile. Coupling system with single-hand operation. High Flow valve for optimum flow and low pressure drop. The series stands out for its robust design and long service life even with the harshest use.

- Available on request:
 - with additional end connections
 - other seals for different temperature ranges and fluids

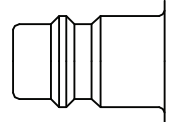

Euro Profile

Dust Protections (P. 357)
for Coupling Part.-No. SK23S
for Plug Part.-No. SK12S

KA Single Shut-Off

Working Pressure*:
up to 35 bar

Material:

- Coupling: Nickel plated brass / steel
- Plug: Zinc plated steel
- Seals: NBR

Working Temperature:
-20°C up to +100°C (NBR)

Flow Rate Air:
1.800 l/min.
inlet pressure 6 bar, pressure drop 0.5 bar

Flow Rate Water:
28 l/min.
pressure drop 0.5 bar

KB Double Shut-Off

Working Pressure*:
up to 35 bar

Material:

- Coupling: Nickel plated brass / steel
- Plug: Nickel plated brass
- Seals: NBR

Working Temperature:
-20°C up to +100°C (NBR)

Flow Rate Air:
710 l/min.
inlet pressure 6 bar, pressure drop 0.5 bar

Flow Rate Water:
7.1 l/min.
pressure drop 0.5 bar

* maximum static working pressure with design factor 4 to 1.

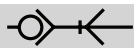

Single Shut-Off

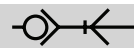

Single Shut-Off

25KAA Coupler with valve, Male Thread

Nickel-plated brass/steel, NBR

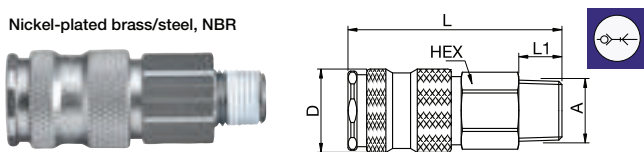

A		HEX	L	L1	D
R1/4	25KAAK13MPN	19	61	12	23
R3/8	25KAAK17MPN	19	60	12	23
R1/2	25KAAK21MPN	22	61	17	23
M14 x 1.5	25KAAD14MPN	19	59	10	23
M16 x 1.5	25KAAD16MPN	19	60	11	23
M18 x 1.5	25KAAD18MPN	19	60	11	23

25KAIW Coupler with valve, Female Thread

Nickel-plated brass/steel, NBR

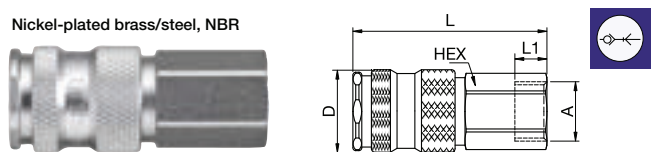

A		HEX	L	L1	D
G1/4	25KAIW13MPN	19	56	10	23
G3/8	25KAIW17MPN	19	55	9	23
G1/2	25KAIW21MPN	24	58	12	23

Series 25 - Brass/Steel

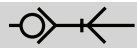

Single Shut-Off

25KAT Coupler with valve, Hose Barb

Nickel-plated brass/steel, NBR

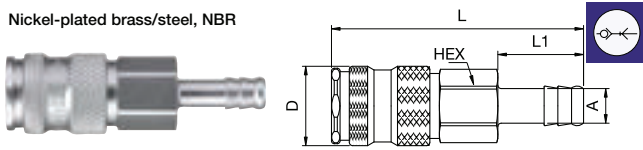

A		HEX	L	L1	D
6	25KATF06MPN	19	74	25	23
8	25KATF08MPN	19	74	25	23
9	25KATF09MPN	19	74	25	23
10	25KATF10MPN	19	74	25	23
13	25KATF13MPN	19	74	25	23
10 Push-Lok	25KATP10MPN	19	73	24	23
13 Push-Lok	25KATP13MPN	19	76	28	23

25KAKO Coupler with valve, with Plastic Hose Connection

Nickel-plated brass/steel, NBR

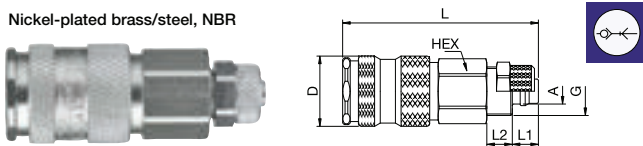

A		HEX	G	L	L1	L2	D
6 x 8	25KAKO08MPN	19	M12x1	61	7	6	23
8 x 10	25KAKO10MPN	19	M16x1	65	9	8	23
9 x 12	25KAKO12MPN	19	M16x1	65	9	8	23

25KATS Coupler with valve, Panel Mount with Hose Barb

Nickel-plated brass/steel, NBR

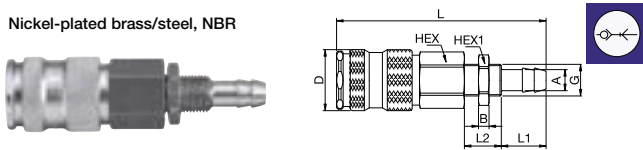

A		HEX	HEX1	B	G	L	L1	L2	D
8	25KATS08MPN	19	17	4	M12x1	80	17	14	23
10	25KATS10MPN	19	17	4	G1/4	87	25	14	23

25KAKK Coupler with valve, Plastic Hose Connection with Spring Guard

Nickel-plated brass/steel, NBR

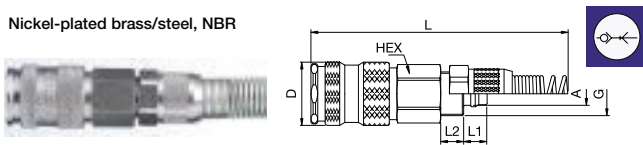

A		HEX	G	L	L1	L2	D
6 x 8	25KAKK08MPN	19	M12x1	144	7	6	23
8 x 10	25KAKK10MPN	19	M16x1	155	9	8	23
9 x 12	25KAKK12MPN	19	M16x1	162	9	8	23

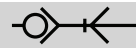

Single Shut-Off

25SFA Plug without valve, Male Thread

Zinc-plated steel

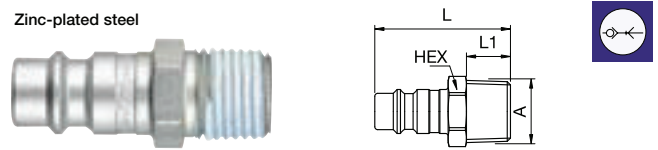

A			HEX	L	L1
R1/8	25SFAK10SXZ		13	33	9
G1/8	25SAFW10SXZ	9087 25 10	13	31	6.5
R1/4	25SFAK13SXZ		14	37	12
G1/4	25SAFW13SXZ	9087 25 13	17	33	8
R3/8	25SFAK17SXZ		17	37	12
G3/8	25SAFW17SXZ	9087 25 17	19	34	9
R1/2	25SFAK21SXZ		22	43	17
G1/2	25SAFW21SXZ	9087 25 21	24	38	10.5

25SFIW Plug without valve, Female Thread

Zinc-plated steel

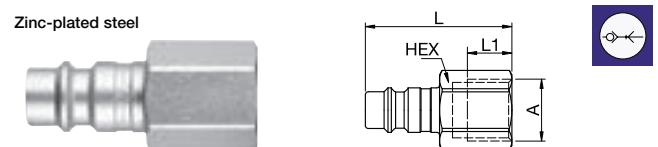

A			HEX	L	L1
G1/8	25SFIW10SXZ	9086 25 10	14	30	5
G1/4	25SFIW13SXZ	9086 25 13	17	38.5	12
G3/8	25SFIW17SXZ	9086 25 17	19	39.5	12
G1/2	25SFIW21SXZ	9086 25 21	24	44	14

25FAAK Plug without valve, Flex Joint, Male Thread

Nickel-plated steel, NBR

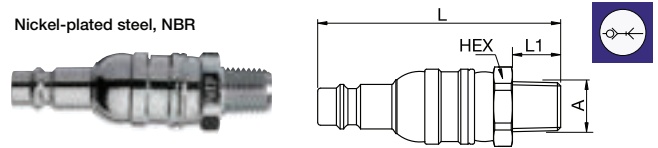

A			HEX	L	L1
R1/4	25FAAK13SPN		17	64	11

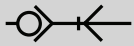

Single Shut-Off

25SFTF Plug without valve, Hose Barb

Zinc-plated steel

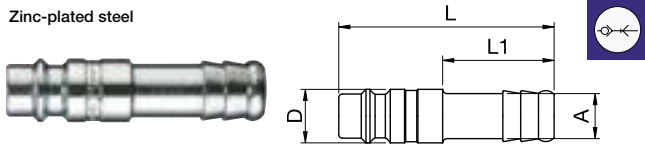

A			L	L1	D
6	25SFTF06SXZ	9085 25 06	48	25	12
8	25SFTF08SXZ	9085 25 08	48	25	12
9	25SFTF09SXZ	9085 25 09	48	25	12
10	25SFTF10SXZ	9085 25 10	48	25	12
13	25SFTF13SXZ	9085 25 13	48	25	15

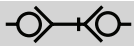

Double Shut-off

25KBA Coupler with valve, Male Thread

Nickel-plated brass/steel or nickel-plated brass, NBR

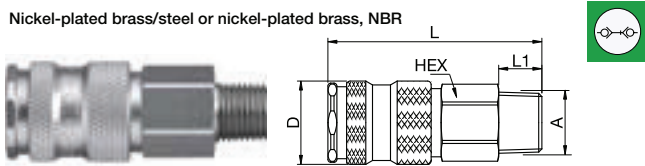

A			HEX	L	L1	D	Version
R1/4	25KBAK13BPN		19	61	12	23	Nickel-plated brass
G1/4	25KBAW13MPN 9201 25 13		19	60	9	23	Nickel-plated brass/steel
R3/8	25KBAK17BPN		19	60	12	23	Nickel-plated brass
G3/8	25KBAW17MPN 9201 25 17		19	58	9	23	Nickel-plated brass/steel
R1/2	25KBAK21BPN		22	61	17	23	Nickel-plated brass
G1/2	25KBAW21MPN 9201 25 21		24	61	12	23	Nickel-plated brass/steel
M14x1.5	25KBAD14BPN		19	59	10	23	Nickel-plated brass
M16x1.5	25KBAD16BPN		19	60	11	23	Nickel-plated brass
M18x1.5	25KBAD18BPN		19	60	11	23	Nickel-plated brass

25KBIW Coupler with valve, Female Thread

Nickel-plated brass/steel or nickel-plated brass, NBR

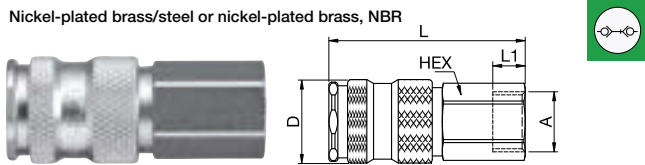

A			HEX	L	L1	D	Version
G1/4	25KBIW13BPN		19	56	10	23	Nickel-plated brass
G1/4	25KBIW13MPN 9214 25 13		19	56	10	23	Nickel-plated brass/steel
G3/8	25KBIW17BPN		19	55	9	23	Nickel-plated brass
G3/8	25KBIW17MPN 9214 25 17		19	55	9	23	Nickel-plated brass/steel
G1/2	25KBIW21BPN		24	58	12	23	Nickel-plated brass
G1/2	25KBIW21MPN 9214 25 21		24	58	12	23	Nickel-plated brass/steel

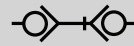

Double Shut-off

25KBT Coupler with valve, Hose Barb

Nickel-plated brass/steel or nickel-plated brass, NBR

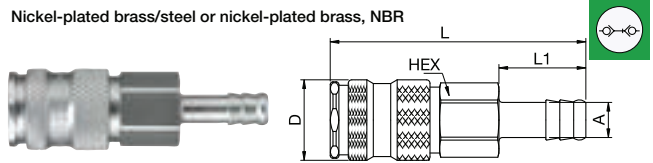

A			HEX	L	L1	D	Version
6	25KBTf06BPN		19	74	25	23	Nickel-plated brass
6	25KBTf06MPN 9223 25 06		19	74	25	23	Nickel-plated brass/steel
8	25KBTf08BPN		19	74	25	23	Nickel-plated brass
8	25KBTf08MPN 9223 25 08		19	74	25	23	Nickel-plated brass/steel
9	25KBTf09BPN		19	74	25	23	Nickel-plated brass
9	25KBTf09MPN		19	74	25	23	Nickel-plated brass/steel
10	25KBTf10BPN		19	74	25	23	Nickel-plated brass
10	25KBTf10MPN 9223 25 10		19	74	25	23	Nickel-plated brass/steel
13	25KBTf13BPN		19	74	25	23	Nickel-plated brass
13	25KBTf13MPN 9223 25 13		19	74	25	23	Nickel-plated brass/steel
10	25KBTp10BPN		19	73	24	23	Nickel-plated brass
13	25KBTp13BPN		19	76	28	23	Nickel-plated brass

25KBKO Coupler with valve, with Plastic Hose Connection

Nickel-plated brass, NBR

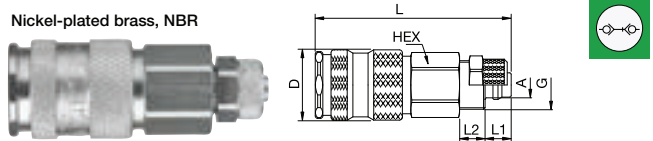

A			HEX	G	L	L1	L2	D
6 x 8	25KBK008BPN		19	M12x1	61	7	6	23
8 x 10	25KBK010BPN		19	M16x1	65	9	8	23
9 x 12	25KBK012BPN		19	M16x1	65	9	8	23

25KBTS Coupler with valve, Panel Mount with Hose Barb

Nickel-plated brass, NBR

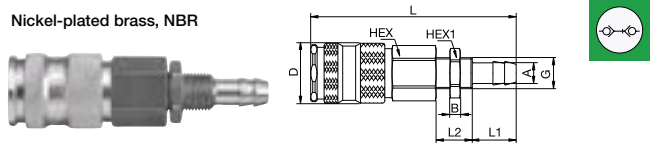

A			HEX	HEX1	B	G	L	L1	L2	D
8	25KBTS08BPN		19	17	4	M12x1	80	17	14	23
10	25KBTS10BPN		19	17	4	M12x1	76	17	10	23

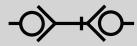

Double Shut-off

25KBKK Coupler with valve, Plastic Hose Connection with Spring Guard

Nickel-plated brass, NBR

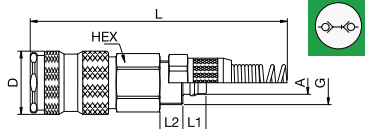

A		HEX	G	L	L1	L2	D
6 x 8	25KBKK08BPN	19	M12x1	144	7	6	23
8 x 10	25KBKK10BPN	19	M16x1	142	7	6	23
9 x 12	25KBKK12BPN	19	M16x1	162	9	8	23

25SBA Plug with valve, Male Thread

Nickel-plated brass, NBR

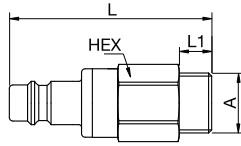

A		HEX	L	L1
G1/8	25SBAW10MPN	22	44.5	9
G1/4	25SBAW13MPN	22	43	9
G3/8	25SBAW17MPN	22	43	9
G1/2	25SBAW21MPN	22	46	12
M14 x 1.5	25SBAD14MPN	22	44	10
M16 x 1.5	25SBAD16MPN	22	45	11
M18 x 1.5	25SBAD18MPN	22	45	11

25SBIW Plug with valve, Female Thread

Nickel-plated brass, NBR

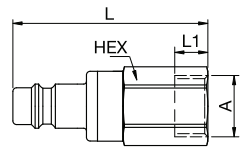

A		HEX	L	L1
G1/4	25SBIW13MPN	22	43	10
G3/8	25SBIW17MPN	22	43	9
G1/2	25SBIW21MPN	24	46	12

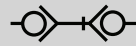

Double Shut-off

25SBT Plug with valve, Hose Barb

Nickel-plated brass, NBR

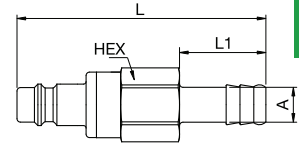
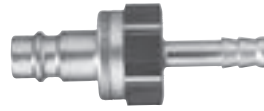

A		HEX	L	L1
6	25SBTF06MPN	21	60	25
8	25SBTF08MPN	21	60	25
9	25SBTF09MPN	21	60	25
10	25SBTF10MPN	21	60	25
13	25SBTF13MPN	21	60	25
10	25SBTP10MPN	19	71	24
13	25SBTP13MPN	19	83	28

25SBK0 Plug with valve, with Plastic Hose Connection

Nickel-plated brass, NBR

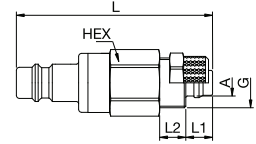

A		HEX	G	L	L1	L2
4 x 6	25SBK006MPN	21	M10x1	47	7	6
6 x 8	25SBK008MPN	21	M12x1	47	7	6
8 x 10	25SBK010MPN	21	M16x1	51	8.5	8.5
9 x 12	25SBK012MPN	21	M16x1	51	8.5	8.5

25SBTS Plug with valve, Panel Mount with Hose Barb

Nickel-plated brass, NBR

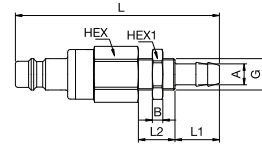

A		HEX	HEX1	B	G	L	L1	L2
8	25SBTS08MPN	21	17	4	M12x1	65	17	14
10	25SBTS10MPN	21	17	3.5	G1/4	74	25	14

25SBKK Plug with valve, Plastic Hose Connection with Spring Guard

Nickel-plated brass, NBR

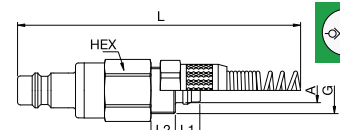

A		HEX	G	L	L1	L2
4 x 6	25SBKK06MPN	19	M10x1	120	7	6
6 x 8	25SBKK08MPN	19	M12x1	135	7	6
8 x 10	25SBKK10MPN	19	M16x1	145	8.5	8.5
9 x 12	25SBKK12MPN	19	M16x1	150	8.5	8.5



Premium industrial coupling 3/8" with European standard profile. Suitable for compressed air applications with greater than average air consumption. Coupling system with single-hand operation. Ultra High Flow valve for optimum flow and low pressure drop.

- Available on request:
 - with additional end connections
 - other seals for different temperature ranges and fluids

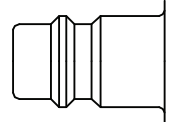

Euro Profile

Dust Protections (P. 357)
for Coupling Part.-No. SK23S
for Plug Part.-No. SK12S

KA Single Shut-Off

Working Pressure*:
up to 35 bar

Material:

- Coupling: Nickel plated brass / QPQ treated steel
- Plug: Zinc plated steel
- Seals: NBR

Working Temperature:
-20°C up to +100°C (NBR)

Flow Rate Air:
2.020 l/min.
inlet pressure 6 bar, pressure drop 0.5 bar

Flow Rate Water:
27 l/min.
pressure drop 0.5 bar

* maximum static working pressure with design factor 4 to 1.

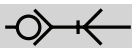

Single Shut-Off

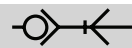

Single Shut-Off

1600KAAK Coupler with valve, Male Thread

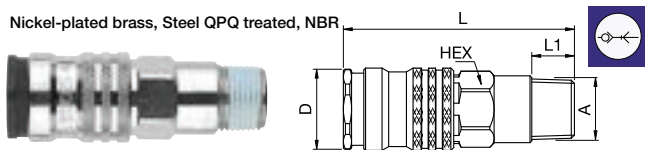

A	HEX	L	L1	D
R1/4 1600KAAK13SPN	19	65	12	23
R3/8 1600KAAK17SPN	19	65	12	23
R1/2 1600KAAK21SPN	22	59.5	17	23

1600KATF Coupler with valve, Hose Barb

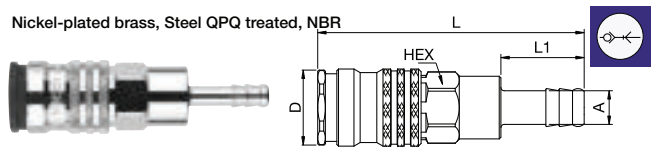

A	HEX	L	L1	D
6 1600KATF06SPN	19	80	25	23
8 1600KATF08SPN	19	80	25	23
9 1600KATF09SPN	19	80	25	23
10 1600KATF10SPN	19	80	25	23
13 1600KATF13SPN	19	80	25	23

1600KAIW Coupler with valve, Female Thread

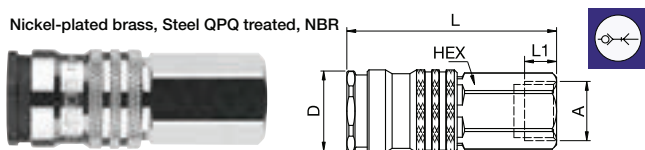

A	HEX	L	L1	D
G1/4 1600KAIW13SPN	19	59	9	23
G3/8 1600KAIW17SPN	19	59	9	23
G1/2 1600KAIW21SPN	24	62	12	23

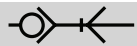

Single Shut-Off

25SFA Plug without valve, Male Thread

Zinc-plated steel

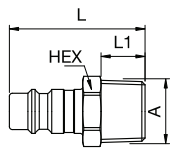

A			HEX	L	L1
R1/8	25SFAK10SXZ		13	33	9
G1/8	25SFAW10SXZ	9087 25 10	13	30.5	6.5
R1/4	25SFAK13SXZ		14	36.5	12
G1/4	25SFAW13SXZ	9087 25 13	17	32.5	8
R3/8	25SFAK17SXZ		17	37	12
G3/8	25SFAW17SXZ	9087 25 17	19	34	9
R1/2	25SFAK21SXZ		22	43	17
G1/2	25SFAW21SXZ	9087 25 21	24	37.5	10.5

25SFIW Plug without valve, Female Thread

Zinc-plated steel

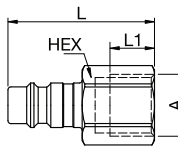

A			HEX	L	L1
G1/8	25SFIW10SXZ	9086 25 10	14	30	5
G1/4	25SFIW13SXZ	9086 25 13	17	38.5	12
G3/8	25SFIW17SXZ	9086 25 17	19	39.5	12
G1/2	25SFIW21SXZ	9086 25 21	24	44	14

25SFTF Plug without valve, Hose Barb

Zinc-plated steel

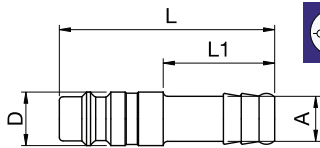

A			L	L1	D
6	25SFTF06SXZ	9085 25 06	48	25	12
8	25SFTF08SXZ	9085 25 08	48	25	12
9	25SFTF09SXZ	9085 25 09	48	25	12
10	25SFTF10SXZ	9085 25 10	48	25	12
13	25SFTF13SXZ	9085 25 13	48	25	15



energy saver



Premium industrial coupling 3/8" with European standard profile. Suitable for compressed air applications with greater than average air consumption. Coupling system with single-hand operation. Ultra High Flow valve for optimum flow and low pressure drop. Extremely robust and ergonomically shaped, 2-component plastic sleeve.

- Available on request:
 - with additional end connections
 - other seals for different temperature ranges and fluids

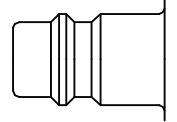

Euro Profile

Dust Protections (P. 357)
for Coupling Part.-No. SK23S
for Plug Part.-No. SK12S

KA
Single Shut-Off

Working Pressure*:
up to 35 bar

Material:

- Coupling: Nickel plated brass, QPQ treated steel, PA6+TPE
- Plug: Zinc plated steel
- Seals: NBR

Working Temperature:
-20°C up to +100°C (NBR)

Flow Rate Air:
2.020 l/min.
inlet pressure 6 bar, pressure drop 0.5 bar

Flow Rate Water:
31 l/min.
pressure drop 0.5 bar

* maximum static working pressure with design factor 4 to 1.

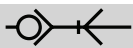

Single Shut-Off

1625KAAK Coupler with valve, Male Thread

Nickel-plated brass, Steel QPQ treated, PA6+TPE, NBR

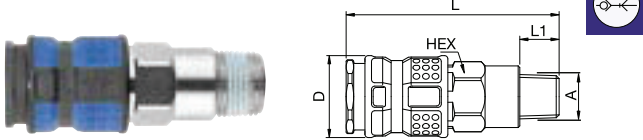

A	HEX	L	L1	D	
R1/4	1625KAAK13SPN	19	65	12	26
R3/8	1625KAAK17SPN	19	65	12	26
R1/2	1625KAAK21SPN	22	59.5	17	26

1625KAIW Coupler with valve, Female Thread

Nickel-plated brass, Steel QPQ treated, PA6+TPE, NBR

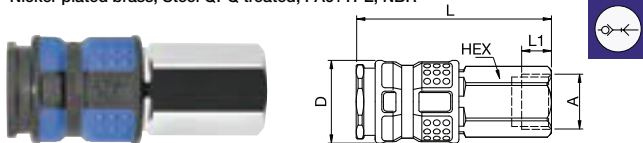

A	HEX	L	L1	D	
G1/4	1625KAIW13SPN	19	59	9	26
G3/8	1625KAIW17SPN	19	59	9	26
G1/2	1625KAIW21SPN	24	62	12	26

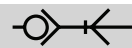

Single Shut-Off

1625KATF Coupler with valve, Hose Barb

Nickel-plated brass, Steel QPQ treated, PA6+TPE, NBR

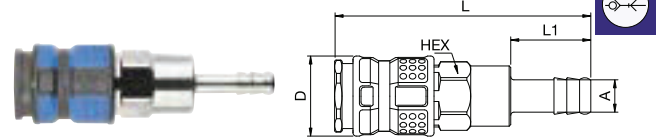

A	HEX	L	L1	D	
6	1625KATF06SPN	19	80	25	26
8	1625KATF08SPN	19	80	25	26
9	1625KATF09SPN	19	80	25	26
10	1625KATF10SPN	19	80	25	26
13	1625KATF13SPN	19	80	25	26

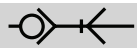

Single Shut-Off

25SFA Plug without valve, Male Thread

Zinc-plated steel

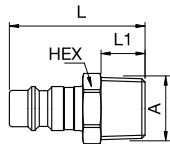

A			HEX	L	L1
R1/8	25SFAK10SXZ		13	33	9
G1/8	25SAFW10SXZ	9087 25 10	13	30.5	6.5
R1/4	25SFAK13SXZ		14	36.5	12
G1/4	25SAFW13SXZ	9087 25 13	17	32.5	8
R3/8	25SFAK17SXZ		17	37	12
G3/8	25SAFW17SXZ	9087 25 17	19	34	9
R1/2	25SFAK21SXZ		22	43	17
G1/2	25SAFW21SXZ	9087 25 21	24	37.5	10.5

25SFIW Plug without valve, Female Thread

Zinc-plated steel

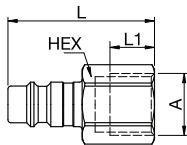

A			HEX	L	L1
G1/8	25SFIW10SXZ	9086 25 10	14	30	5
G1/4	25SFIW13SXZ	9086 25 13	17	38.5	12
G3/8	25SFIW17SXZ	9086 25 17	19	39.5	12
G1/2	25SFIW21SXZ	9086 25 21	24	44	14

25SFTF Plug without valve, Hose Barb

Zinc-plated steel

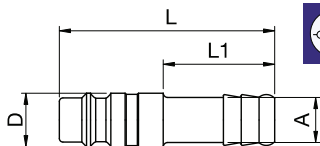

A			L	L1	D
6	25SFTF06SXZ	9085 25 06	48	25	12
8	25SFTF08SXZ	9085 25 08	48	25	12
9	25SFTF09SXZ	9085 25 09	48	25	12
10	25SFTF10SXZ	9085 25 10	48	25	12
13	25SFTF13SXZ	9085 25 13	48	25	15



Steel industrial coupling with Atlas Copco-Profile. Specially suited to use with gaseous media in industry. Coupling system with single-hand operation. High Flow valve for optimum flow and low pressure drop.

- Available on request:
 - with additional end connections
 - other seals for different temperature ranges and fluids

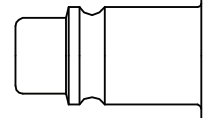

Scandinavian Profile

Dust Protections (P. 357)
for Coupling Part.-No. SK23S
for Plug Part.-No. SK12S

KA Single Shut-Off

Working Pressure*:
up to 35 bar

Material:

- Coupling: Nickel plated brass / steel
- Plug: Nickel plated steel
- Seals: NBR

Working Temperature:
-20°C up to +100°C (NBR)

Flow Rate Air:
1.700 l/min.
inlet pressure 6 bar, pressure drop 0.5 bar

Flow Rate Water:
23 l/min.
pressure drop 0.5 bar

* maximum static working pressure with design factor 4 to 1.

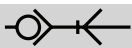

Single Shut-Off

33KAAK Coupler with valve, Male Thread

Nickel-plated brass/steel, NBR

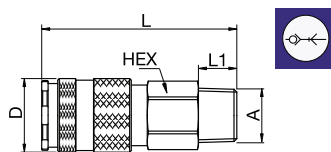

A		HEX	L	L1	D
R1/4	33KAAK13SPN	19	60	12	23
R3/8	33KAAK17SPN	19	59	12	23
R1/2	33KAAK21SPN	22	60	17	23

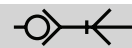

Single Shut-Off

33KATF Coupler with valve, Hose Barb

Nickel-plated brass/steel, NBR

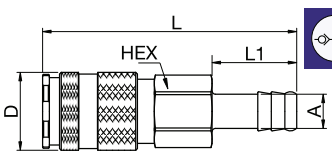

A		HEX	L	L1	D
6	33KATF06SPN	19	73	25	23
8	33KATF08SPN	19	73	25	23
10	33KATF10SPN	19	73	25	23
13	33KATF13SPN	19	73	25	23

33KAIW Coupler with valve, Female Thread

Nickel-plated brass/steel, NBR

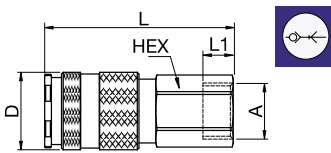

A		HEX	L	L1	D
G1/4	33KAIW13SPN	19	55	10	23
G3/8	33KAIW17SPN	19	54	9	23
G1/2	33KAIW21SPN	24	57	12	23

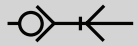

Single Shut-Off

33SFAK Plug without valve, Male Thread

Nickel-plated steel

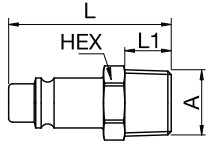

A		HEX	L	L1
R1/4	33SFAK13SXN	14	42	12
R3/8	33SFAK17SXN	17	42	12
R1/2	33SFAK21SXN	22	47	17

33SFIW Plug without valve, Female Thread

Nickel-plated steel

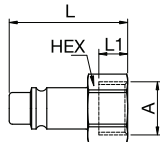

A		HEX	L	L1
G1/4	33SFIW13SXN	17	37	9
G3/8	33SFIW17SXN	17	37	9
G1/2	33SFIW21SXN	24	42	12

33SFTF Plug without valve, Hose Barb

Nickel-plated steel

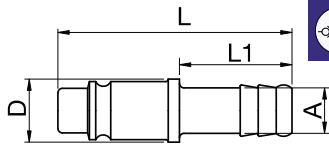

A		L	L1	D
6	33SFTF06SXN	52	25	14
8	33SFTF08SXN	52	25	14
10	33SFTF10SXN	52	25	15
13	33SFTF13SXN	52	25	15



Steel coupling 3/8" according to ISO 6150 B and US MIL-SPEC 4109. Very robust design with steel valve bodies. The high insertion depth guarantees by an optimised plug guidance.

- Available on request:
 - in brass material with nickel plating
 - with additional end connections
 - other seals for different temperature ranges and fluids

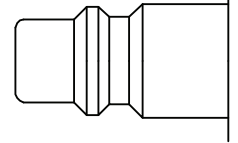

ISO B Profile

KA
Single Shut-Off

Working Pressure*:
up to 35 bar

Material:

- Coupling: Brass / Steel
- Plug: Nickel plated steel
- Seals: NBR

Working Temperature:
-20°C up to +100°C (NBR)

Flow Rate Air:
1.050 l/min.
inlet pressure 6 bar, pressure drop 0.5 bar

Flow Rate Water:
14 l/min.
pressure drop 0.5 bar

* maximum static working pressure with design factor 4 to 1.

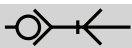

Single Shut-Off

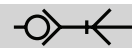

Single Shut-Off

30KAAW Coupler with valve, Male Thread

Brass/steel, NBR

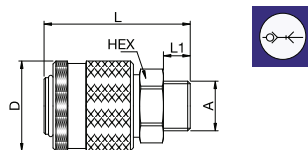

A	HEX	L	L1	D
G1/4 30KAAW13SPX	22	49	9	30
G3/8 30KAAW17SPX	22	49	9	30
G1/2 30KAAW21SPX	22	52	12	30

30KATF Coupler with valve, Hose Barb

Brass/steel, NBR

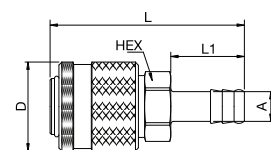
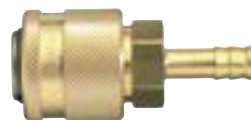

A	HEX	L	L1	D
6 30KATF06SPX	21	66	25	30
8 30KATF08SPX	21	66	25	30
10 30KATF10SPX	21	66	25	30
13 30KATF13SPX	21	66	25	30

30KAIW Coupler with valve, Female Thread

Brass/steel, NBR

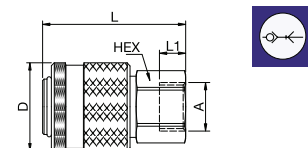

A	HEX	L	L1	D
G1/4 30KAIW13SPX	22	49	11	30
G3/8 30KAIW17SPX	22	49	9	30
G1/2 30KAIW21SPX	22	52	12	30

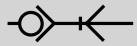

Single Shut-Off

30SFAW Plug without valve, Male Thread

Nickel-plated steel

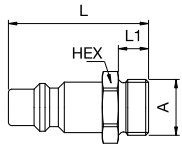

A			HEX	L	L1
G1/4	30SFAW13SXN	9087 30 13	17	42	9
G3/8	30SFAW17SXN	9087 30 17	19	42	9
G1/2	30SFAW21SXN	9087 30 21	24	46	12

30SFIW Plug without valve, Female Thread

Nickel-plated steel

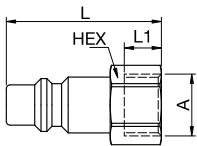

A			HEX	L	L1
G1/4	30SFIW13SXN	9086 30 13	17	40	10
G3/8	30SFIW17SXN	9086 30 17	19	42	10
G1/2	30SFIW21SXN	9086 30 21	24	43	12

30SFTF Plug without valve, Hose Barb

Nickel-plated steel

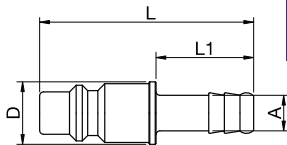

A			L	L1	D
8	30SFTF08SXN	9085 30 08	55	25	16
10	30SFTF10SXN	9085 30 10	55	25	16
13	30SFTF13SXN	9085 30 13	55	25	16



Brass coupling system produced for harsh applications. The system is suitable for use with non aggressive liquid media. The couplings are corrosion resistant. Coupling system with single-hand operation. The ergonomic sleeve design prevents entering dirt on the valve body.

- Available on request:
 - in brass material without nickel plating
 - with additional end connections
 - other seals for different temperature ranges and fluids

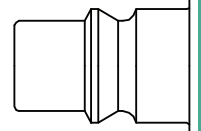

ARO Profile



Working Pressure*:
up to 35 bar

Material:

- Coupling: Nickel plated brass
- Plug: Nickel plated steel
- Seals: NBR

Working Temperature:

-20°C up to +100°C (NBR)

Flow Rate Air:

1.400 l/min.
inlet pressure 6 bar, pressure drop 0.5 bar

Flow Rate Water:

18 l/min.
pressure drop 0.5 bar

* maximum static working pressure with design factor 4 to 1.

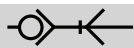

Single Shut-Off

40KAIW Coupler with valve, Female Thread

Nickel-plated brass, NBR

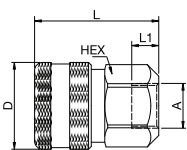

A	HEX	L	L1	D
G3/8	40KAIW17MPN	27	46	10 32
G1/2	40KAIW21MPN	27	46	11 32

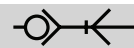

Single Shut-Off

40SFIW Plug without valve, Female Thread

Nickel-plated steel

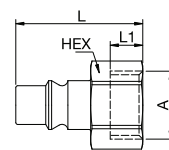

A	HEX	L	L1
G3/8	40SFIW17SXN	19	35 9
G1/2	40SFIW21SXN	24	39 12

40SFAK Plug without valve, Male Thread

Nickel-plated steel

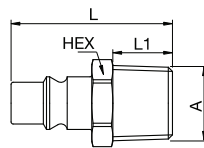

A	HEX	L	L1
R3/8	40SFAK17SXN	16	40 12
R1/2	40SFAK21SXN	16	46 17

40SFTF Plug without valve, Hose Barb

Nickel-plated steel

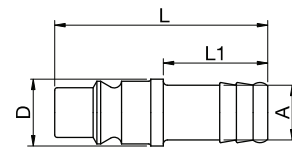

A	L	L1	D
8	40SFTF08SXN	51	25 16
10	40SFTF10SXN	51	25 16
13	40SFTF13SXN	51	25 16



1/2" Universal industrial coupling with standard European profile for use with large pneumatic consumers. Coupling system with single-hand operation. High Flow valve for optimum flow and low pressure drop. The series stands out for its robust design (steel sleeve), extremely high flow and long service life even with the harshest use. The collar design minimises damage to the valve body.

- Available on request:
 - in brass material with nickel plating
 - with additional end connections
 - other seals for different temperature ranges and fluids

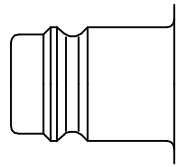

Euro Profile

Dust Protections (P. 357)
for Coupling Part.-No. SK27S

KA Single Shut-Off

Working Pressure*:
up to 35 bar

Material:

- Coupling: Nickel plated brass / steel
- Plug: Nickel plated steel
- Seals: NBR

Working Temperature:
-20°C up to +100°C (NBR)

Flow Rate Air:
2.400 l/min.
inlet pressure 6 bar, pressure drop 0.5 bar

Flow Rate Water:
31 l/min.
pressure drop 0.5 bar

KB Double Shut-Off

Working Pressure*:
up to 35 bar

Material:

- Coupling: Brass
- Plug: Nickel plated brass
- Seals: NBR

Working Temperature:
-20°C up to +100°C (NBR)

Flow Rate Air:
950 l/min.
inlet pressure 6 bar, pressure drop 0.5 bar

Flow Rate Water:
14 l/min.
pressure drop 0.5 bar

* maximum static working pressure with design factor 4 to 1.

Single Shut-Off

Single Shut-Off

27KAAK Coupler with valve, Male Thread

Nickel-plated brass / Steel, NBR

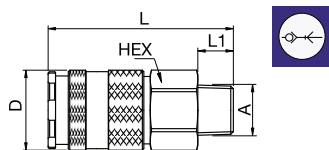
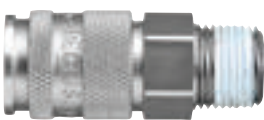

A		HEX	L	L1	D
R1/4	27KAAK13MPN	24	63	12	27
R3/8	27KAAK17MPN	24	63	12	27
R1/2	27KAAK21MPN	24	65	17	27
R3/4	27KAAK26MPN	27	65	17	27

27KAIW Coupler with valve, Female Thread

Nickel-plated brass / Steel, NBR

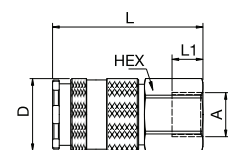

A		HEX	L	L1	D
G1/4	27KAIW13MPN	24	56	10	27
G3/8	27KAIW17MPN	24	56	11	27
G1/2	27KAIW21MPN	24	56	12	27
G3/4	27KAIW26MPN	27	60	16	27

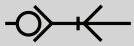

Single Shut-Off

27KATF Coupler with valve, Hose Barb

Nickel-plated brass / Steel, NBR

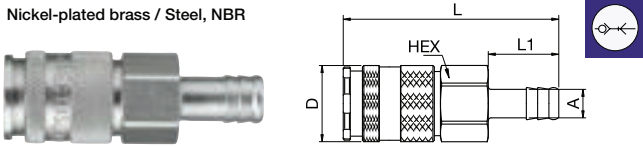

A		HEX	L	L1	D
8	27KATF08MPN	24	76	25	27
9	27KATF09MPN	24	76	25	27
10	27KATF10MPN	24	76	25	27
13	27KATF13MPN	24	76	25	27
16	27KATF16MPN	24	76	20	27
19	27KATF19MPN	24	76	25	27

27SFAK Plug without valve, Male Thread

Nickel-plated steel

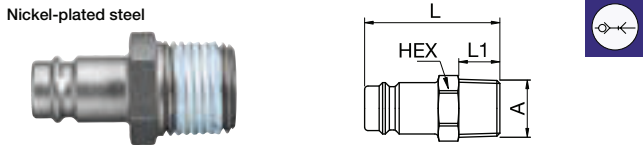

A		HEX	L	L1
R1/4	27SFAK13SXN	17	40	12
R3/8	27SFAK17SXN	17	40	12
R1/2	27SFAK21SXN	22	45	17
R3/4	27SFAK26SXN	27	48	19

27SFIW Plug without valve, Female Thread

Nickel-plated steel

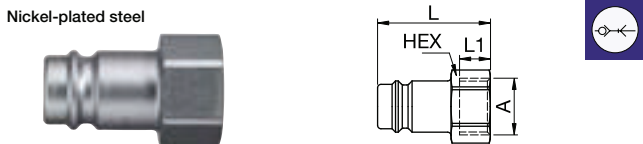

A		HEX	L	L1
G1/4	27SFIW13SXN	17	33	9
G3/8	27SFIW17SXN	9086 27 17	19	33
G1/2	27SFIW21SXN	9086 27 21	24	37
G3/4	27SFIW26SXN	9086 27 27	32	42

27SFTF Plug without valve, Hose Barb

Nickel-plated steel

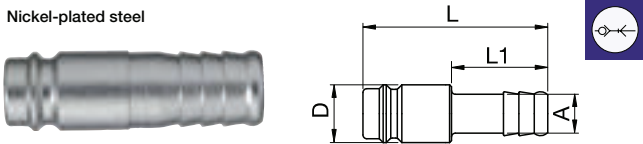

A		L	L1	D
6	27SFTF06SXN	48	25	15
8	27SFTF08SXN	9085 27 08	48	25
9	27SFTF09SXN	48	25	15
10	27SFTF10SXN	9085 27 10	48	25
13	27SFTF13SXN	9085 27 13	48	25
16	27SFTF16SXN	49	25	18
19	27SFTF19SXN	9085 27 19	49	25

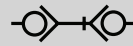

Double Shut-off

27KBAK Coupler with valve, Male Thread

Nickel-plated brass, NBR

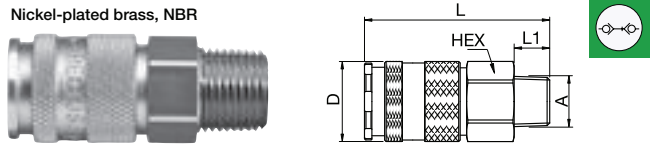

A		HEX	L	L1	D
R1/4	27KBAK13BPN	24	63	12	27
R3/8	27KBAK17BPN	24	63	12	27
R1/2	27KBAK21BPN	24	65	17	27
R3/4	27KBAK26BPN	27	65	17	27

27KBIW Coupler with valve, Female Thread

Nickel-plated brass, NBR

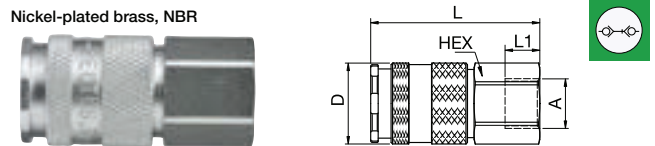

A		HEX	L	L1	D
G1/4	27KBIW13BPN	24	56	10	27
G3/8	27KBIW17BPN	24	56	11	27
G1/2	27KBIW21BPN	24	56	12	27
G3/4	27KBIW26BPN	32	60	16	27

27KBTf Coupler with valve, Hose Barb

Nickel-plated brass, NBR

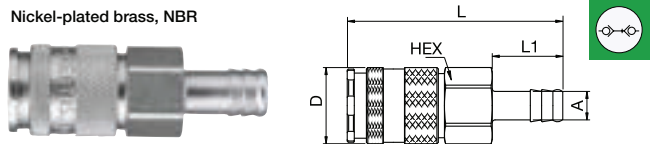

A		HEX	L	L1	D
8	27KBTf08BPN	24	76	25	27
9	27KBTf09BPN	24	76	25	27
10	27KBTf10BPN	24	76	25	27
13	27KBTf13BPN	24	76	25	27
16	27KBTf16BPN	24	76	25	27
19	27KBTf19BPN	24	76	25	27

27SBAK Plug with valve, Male Thread

Nickel-plated brass, NBR

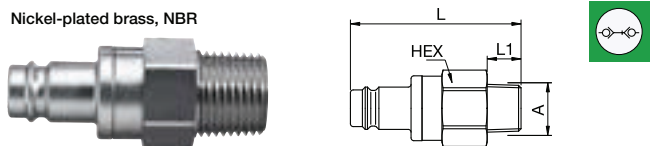

A		HEX	L	L1
R1/4	27SBAK13MPN	24	60.5	12
R3/8	27SBAK17MPN	24	60.5	12
R1/2	27SBAK21MPN	24	62.5	17
R3/4	27SBAK26MPN	27	62.5	17

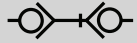

Double Shut-off

27SBIW Plug with valve, Female Thread

Nickel-plated brass, NBR

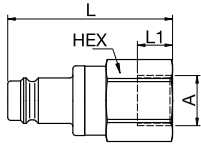

A			HEX	L	L1
G1/4	27SBIW13MPN		24	55	9
G3/8	27SBIW17MPN	9286 27 17	24	55	9
G1/2	27SBIW21MPN	9286 27 21	24	55	12
G3/4	27SBIW26MPN	9286 27 27	32	58	16

27SBTF Plug with valve, Hose Barb

Nickel-plated brass, NBR

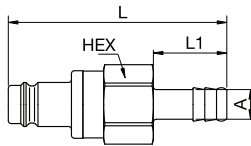

A			HEX	L	L1
8	27SBTF08MPN	9285 27 08	24	75	25
9	27SBTF09MPN		24	75	25
10	27SBTF10MPN	9285 27 10	24	75	25
13	27SBTF13MPN	9285 27 13	24	75	25
16	27SBTF16MPN		24	75	25
19	27SBTF19MPN	9285 27 19	24	75	25



energy
saver

Premium industrial coupling 1/2" with standard European profile. Suitable for compressed air applications with greater than average air consumption. Above average flow values compared with standard market products. Coupling system with single-hand operation. Ultra High Flow valve for optimum flow and low pressure drop.

- Available on request:
 - with additional end connections
 - other seals for different temperature ranges and fluids

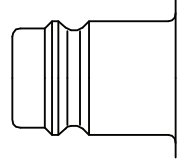

Euro Profile

Dust Protections (P. 357)
for Coupling Part.-No. SK27S

KA Single Shut-Off

Working Pressure*:
up to 35 bar

Material:

- Coupling: Nickel plated brass, QPQ treated steel
- Plug: Nickel plated steel
- Seals: NBR

Working Temperature:
-20°C up to +100°C (NBR)

Flow Rate Air:
3.500 l/min.
inlet pressure 6 bar, pressure drop 0.5 bar

Flow Rate Water:
51 l/min.
pressure drop 0.5 bar

* maximum static working pressure with design factor 4 to 1.

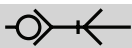

Single Shut-Off

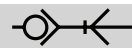

Single Shut-Off

1700KAAK Coupler with valve, Male Thread

Nickel-plated brass, Steel QPQ treated, NBR

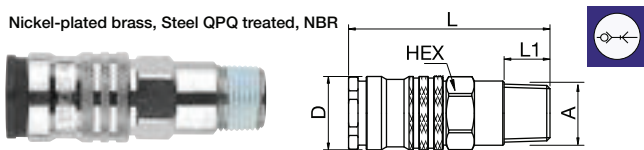

A	HEX	L	L1	D
R3/8 1700KAAK17SPN	24	70	12	27
R1/2 1700KAAK21SPN	24	75	17	27
R3/4 1700KAAK26SPN	27	64	17	27

1700KATF Coupler with valve, Hose Barb

Nickel-plated brass, Steel QPQ treated, NBR

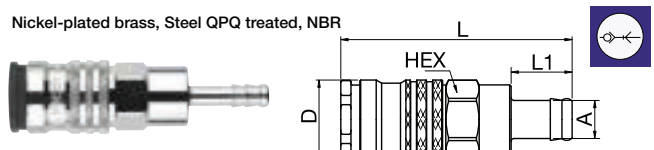

A	HEX	L	L1	D
10 1700KATF10SPN	24	80	21	27
13 1700KATF13SPN	24	80	21	27
16 1700KATF16SPN	24	80	21	27
19 1700KATF19SPN	24	80	21	27

1700KAIW Coupler with valve, Female Thread

Nickel-plated brass, Steel QPQ treated, NBR

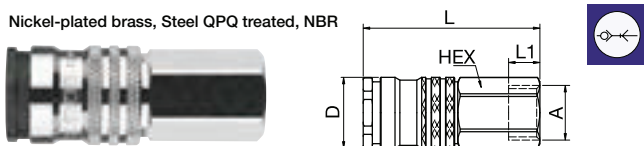

A	HEX	L	L1	D
G3/8 1700KAIW17SPN	24	64.5	10	27
G1/2 1700KAIW21SPN	24	68	11	27
G3/4 1700KAIW26SPN	32	69	14	27

Series 1700 - Brass/Steel

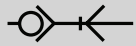

Single Shut-Off

27SFAK Plug without valve, Male Thread

Nickel-plated steel

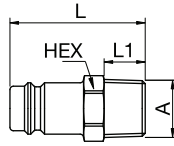

A



HEX L L1

R1/4	27SFAK13SXN	17	40	12
R3/8	27SFAK17SXN	17	40	12
R1/2	27SFAK21SXN	22	45	17
R3/4	27SFAK26SXN	27	48	19

27SFIW Plug without valve, Female Thread

Nickel-plated steel

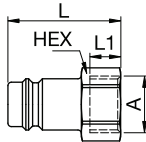

A



HEX L L1

G1/4	27SFIW13SXN	17	33	9	
G3/8	27SFIW17SXN	9086 27 17	19	33	9
G1/2	27SFIW21SXN	9086 27 21	24	37	12
G3/4	27SFIW26SXN	9086 27 27	32	42	16

27SFTF Plug without valve, Hose Barb

Nickel-plated steel

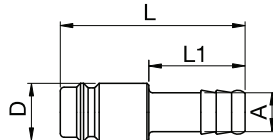

A



L L1 D

6	27SFTF06SXN	48	25	15	
8	27SFTF08SXN	9085 27 08	48	25	15
9	27SFTF09SXN	48	25	15	
10	27SFTF10SXN	9085 27 10	48	25	15
13	27SFTF13SXN	9085 27 13	48	25	15
16	27SFTF16SXN	49	25	18	
19	27SFTF19SXN	9085 27 19	49	25	21



Premium industrial coupling 1/2" with standard European profile. Suitable for compressed air applications with greater than average air consumption. Above average flow values compared with standard market products. Coupling system with single-hand operation. Ultra High Flow valve for optimum flow and low pressure drop. Extremely robust and ergonomically shaped, 2-component plastic sleeve.

- Available on request:
 - with additional end connections
 - other seals for different temperature ranges and fluids

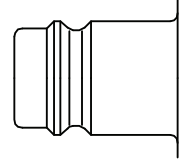

Euro Profile

Dust Protections (P. 357)
for Coupling Part.-No. SK27S
for Plug Part.-No. SK16S

KA
Single Shut-Off

Working Pressure*:
up to 35 bar

Material:

- Coupling: Nickel plated brass, QPQ treated steel, PA6+TPE
- Plug: Nickel plated steel
- Seals: NBR

Working Temperature:
-20°C up to +40°C (NBR)

Flow Rate Air:
3.500 l/min.
inlet pressure 6 bar, pressure drop 0.5 bar

Flow Rate Water:
51 l/min.
pressure drop 0.5 bar

* maximum static working pressure with design factor 4 to 1.

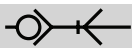

Single Shut-Off

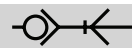

Single Shut-Off

1727KAAK Coupler with valve, Male Thread

Nickel-plated brass, Steel QPQ treated, PA6+TPE, NBR

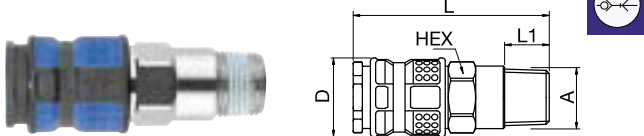

A		HEX	L	L1	D
R3/8	1727KAAK17SPN	24	70	12	30
R1/2	1727KAAK21SPN	24	75	17	30
R3/4	1727KAAK26SPN	27	64	17	30

1727KATF Coupler with valve, Hose Barb

Nickel-plated brass, Steel QPQ treated, PA6+TPE, NBR

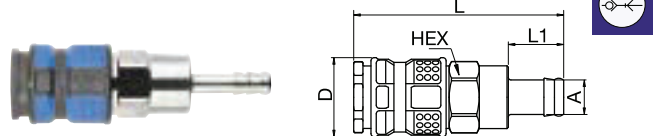

A		HEX	L	L1	D
10	1727KATF10SPN	24	80	21	30
13	1727KATF13SPN	24	80	21	30
16	1727KATF16SPN	24	80	21	30
19	1727KATF19SPN	24	80	21	30

1727KAIW Coupler with valve, Female Thread

Nickel-plated brass, Steel QPQ treated, PA6+TPE, NBR

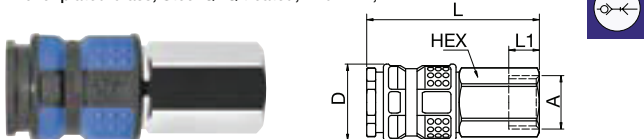

A		HEX	L	L1	D
G3/8	1727KAIW17SPN	24	64.5	10	30
G1/2	1727KAIW21SPN	24	68	12	30
G3/4	1727KAIW26SPN	32	69	14	30

Series 1727 - Brass/Steel

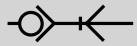

Single Shut-Off

27SFAK Plug without valve, Male Thread

Nickel-plated steel

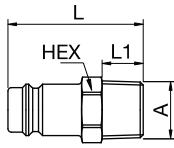
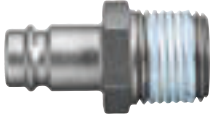

HEX L L1

R1/4	27SFAK13SXN		17	40	12
R3/8	27SFAK17SXN		17	40	12
R1/2	27SFAK21SXN		22	45	17
R3/4	27SFAK26SXN		27	48	19

27SFIW Plug without valve, Female Thread

Nickel-plated steel

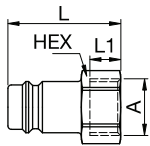

HEX L L1

G1/4	27SFIW13SXN		17	33	9
G3/8	27SFIW17SXN	9086 27 17	19	33	9
G1/2	27SFIW21SXN	9086 27 21	24	37	12
G3/4	27SFIW26SXN	9086 27 27	32	42	16

27SFTF Plug without valve, Hose Barb

Nickel-plated steel

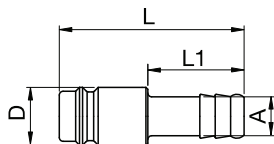

L L1 D

6	27SFTF06SXN		48	25	15
8	27SFTF08SXN	9085 27 08	48	25	15
9	27SFTF09SXN		48	25	15
10	27SFTF10SXN	9085 27 10	48	25	15
13	27SFTF13SXN	9085 27 13	48	25	15
16	27SFTF16SXN		49	25	18
19	27SFTF19SXN	9085 27 19	49	25	21



Industrial coupling with Atlas Copco-Profile. Coupling system with single-hand operation. High Flow valve for optimum flow and low pressure drop. Optimal for use with large pneumatic consumers due to the robust design and steel sleeve. The collar design minimises damage to the valve body.

- Available on request:
 - with additional end connections
 - other seals for different temperature ranges and fluids

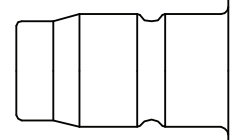

Scandinavian Profile

Dust Protections (P. 357)
for Coupling Part.-No. SK27S

KA
Single Shut-Off

Working Pressure*:
up to 35 bar

Material:

- Coupling: Nickel plated brass / steel
- Plug: Nickel plated steel
- Seals: NBR

Working Temperature:
-20°C up to +100°C (NBR)

Flow Rate Air:
2.550 l/min.
inlet pressure 6 bar, pressure drop 0.5 bar

Flow Rate Water:
30 l/min.
pressure drop 0.5 bar

* maximum static working pressure with design factor 4 to 1.

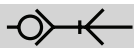

Single Shut-Off

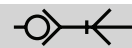

Single Shut-Off

34KAAK Coupler with valve, Male Thread

Nickel-plated brass/steel, NBR

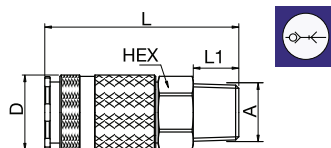

A		HEX	L	L1	D
R3/8	34KAAK17SPN	24	70	12	28
R1/2	34KAAK21SPN	24	72	12	28
R3/4	34KAAK26SPN	27	72	12	28

34KATF Coupler with valve, Hose Barb

Nickel-plated brass/steel, NBR

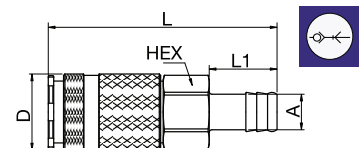

A		HEX	L	L1	D
10	34KATF10SPN	24	84	25	28
13	34KATF13SPN	24	84	25	28
16	34KATF16SPN	24	84	25	28
19	34KATF19SPN	24	84	25	28

34KAIW Coupler with valve, Female Thread

Nickel-plated brass/steel, NBR

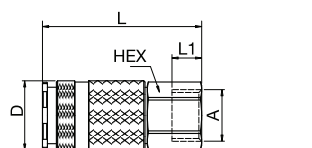

A		HEX	L	L1	D
G3/8	34KAIW17SPN	24	64	12	28
G1/2	34KAIW21SPN	24	64	12	28
G3/4	34KAIW26SPN	32	68.5	14	28

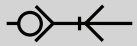

Single Shut-Off

34SFAK Plug without valve, Male Thread

Nickel-plated steel

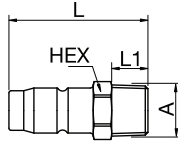

A



HEX L L1

R1/4	34SFAK13SXN	17	46	12
R3/8	34SFAK17SXN	19	46	12
R1/2	34SFAK21SXN	22	52	17

34SFIW Plug without valve, Female Thread

Nickel-plated steel

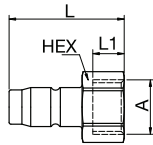

A



HEX L L1

G3/8	34SFIW17SXN	19	40	9
G1/2	34SFIW21SXN	24	44	12

34SFTF Plug without valve, Hose Barb

Nickel-plated steel

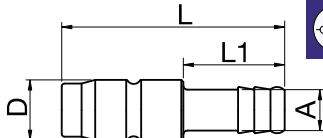

A



L L1 D

10	34SFTF10SXN	55	25	15
13	34SFTF13SXN	55	25	15



Brass coupling with no valve for applications with liquids in the pressure range up to 35 bar. The couplings are corrosion resistant. The system stands out for a high flow with minimal pressure drop.

- Available on request:
 - with additional end connections
 - other seals for different temperature ranges and fluids

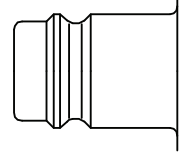

various Profile

KF Straight-Through

Working Pressure*:
up to 35 bar

Material:

- Coupling: Nickel plated brass
- Plug: Nickel plated steel
- Seals: NBR

Working Temperature:

-20°C up to +100°C (NBR)

Flow Rate Water:

58 l/min.

pressure drop 0.5 bar

* maximum static working pressure with design factor 4 to 1.

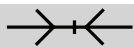

Straight-Through

41KFAW Coupler without valve, Male Thread

Nickel-plated brass, NBR

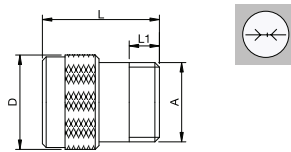

A		L	L1	D
G1/2	 41KFAW21MPN	31	8	25

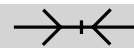



Straight-Through

41KFTF Coupler without valve, Hose Barb

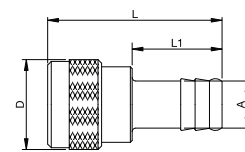
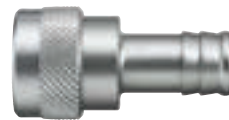
Nickel-plated brass, NBR



A		L	L1	D
13	 41KFTF13MPN	48.5	25	25
19	 41KFTF19MPN	48.5	25	25

41KFIW Coupler without valve, Female Thread

Nickel-plated brass, NBR

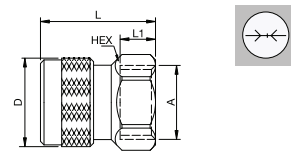

A		HEX	L	L1	D
G1/2	 41KFIW21MPN	24	32.5	10	25

41SFAW Plug without valve, Male Thread

Nickel-plated brass

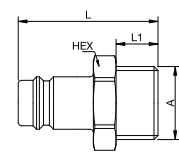

A		HEX	L	L1
G1/2	 41SFAW21MXN	24	40	12

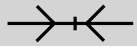

Straight-Through

41SFIW Plug without valve, Female Thread

Nickel-plated brass

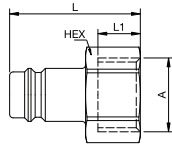
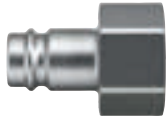

A



HEX L L1

G1/2 41SFIW21MXN

24 37 12

41SFTF Plug without valve, Hose Barb

Nickel-plated brass

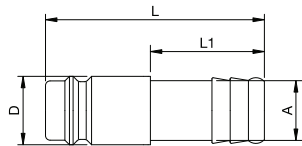

A



L L1 D

13 41SFTF13MXN

48 25 15

19 41SFTF19MXN

49 25 21



Robust brass coupling system 1/2" according to ISO 6150 B and US MIL-SPEC 4109. Coupling system with single-hand operation. The high insertion depth guarantees by an optimised plug guidance.

- Available on request:
 - with additional end connections
 - other seals for different temperature ranges and fluids

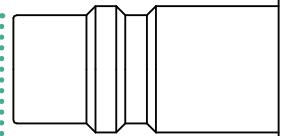

ISO B Profile

Dust Protections (P. 357)
for Coupling Part.-No. SK27S
for Plug Part.-No. SK16S



Working Pressure*:
up to 35 bar

Material:

- Coupling: Nickel plated brass / steel
- Plug: Nickel plated steel
- Seals: NBR

Working Temperature:

-20°C up to +100°C (NBR)

Flow Rate Air:

2.600 l/min.

inlet pressure 6 bar, pressure drop 0.5 bar

Flow Rate Water:

33 l/min.

pressure drop 0.5 bar

* maximum static working pressure with design factor 4 to 1.

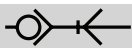

Single Shut-Off

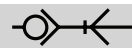

Single Shut-Off

37KAAW Coupler with valve, Male Thread

Brass, NBR

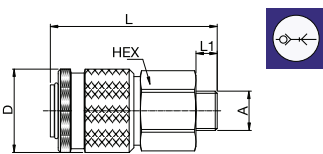

A	HEX	L	L1	D
G1/2	37KAAW21MPX	30	76.5	12 35

37KATF Coupler with valve, Hose Barb

Brass, NBR

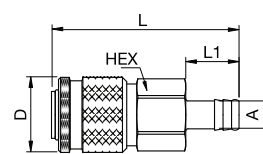

A	HEX	L	L1	D
13	37KATF13MPX	30	86	25 35
19	37KATF19MPX	30	86	25 35

37KAIW Coupler with valve, Female Thread

Brass, NBR

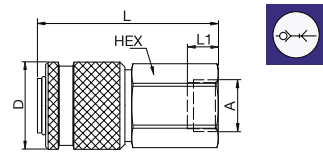

A	HEX	L	L1	D
G1/2	37KAIW21MPX	30	73	10 35

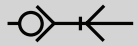

Single Shut-Off

37SFAK Plug without valve, Male Thread

Nickel-plated steel

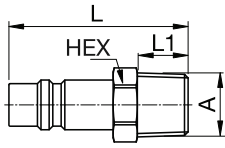

A



HEX L L1

R1/2 37SFAK21SXN

22 60 17

37SFIW Plug without valve, Female Thread

Nickel-plated steel

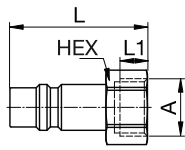

A



HEX L L1

G1/2 37SFIW21SXN

24 50 10

37SFTF Plug without valve, Hose Barb

Nickel-plated steel

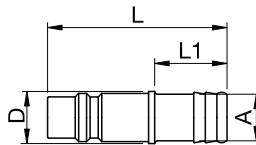

A



L L1 D

13 37SFTF13SXN

62 25 17

16 37SFTF16SXN

62 25 18

19 37SFTF19SXN

72 35 21



German industrial profile for compressed air applications. High Flow valve for optimum flow and low pressure drop. Robust structure, optimised with respect to size and performance. The collar design minimises damage to the valve body.

- Available on request:
 - with additional end connections
 - other seals for different temperature ranges and fluids

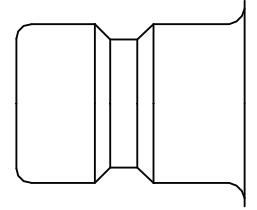

German Profile

KA Single Shut-Off

Working Pressure*:
up to 35 bar

Material:

- Coupling: Nickel plated brass
- Plug: Nickel plated steel
- Seals: NBR

Working Temperature:
-20°C up to +100°C (NBR)

Flow Rate Air:
6.500 l/min.
inlet pressure 6 bar, pressure drop 0.5 bar

Flow Rate Water:
65 l/min.
pressure drop 0.5 bar

KB Double Shut-Off

Working Pressure*:
up to 35 bar

Material:

- Coupling: Nickel plated brass
- Plug: Nickel plated brass
- Seals: NBR

Working Temperature:
-20°C up to +100°C (NBR)

Flow Rate Air:
4.300 l/min.
inlet pressure 6 bar, pressure drop 0.5 bar

Flow Rate Water:
52 l/min.
pressure drop 0.5 bar

* maximum static working pressure with design factor 4 to 1.

Single Shut-Off / Double Shut-off

Single Shut-Off

57KBAW Coupler with valve, Male Thread

Nickel-plated brass, NBR

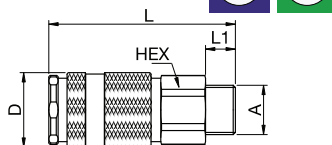

A	HEX	L	L1	D
G1/2 57KBAW21BPN	34	98	12	40
G3/4 57KBAW26BPN	34	100	16	40

57SFAW Plug without valve, Male Thread

Nickel-plated steel

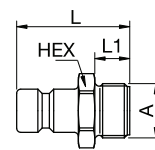

A	HEX	L	L1
G1/2 57SFAW21SXN	27	52	15

57KBIW Coupler with valve, Female Thread

Nickel-plated brass, NBR

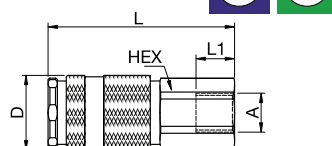

A	HEX	L	L1	D
G1/2 57KBIW21BPN	34	100	19	40
G3/4 57KBIW26BPN	34	100	16	40

57SFIW Plug without valve, Female Thread

Nickel-plated steel

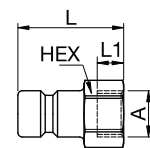

A	HEX	L	L1
G1/2 57SFIW21SXN	27	48	15

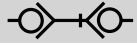

Double Shut-off

57SBAW Plug with valve, Male Thread

Nickel-plated brass, NBR

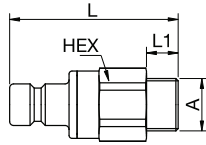

A		HEX	L	L1
G1/2	57SBAW21MPN	34	83	12
G3/4	57SBAW26MPN	34	85	16

57SBIW Plug with valve, Female Thread

Nickel-plated brass, NBR

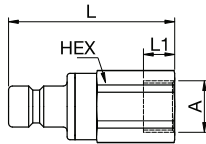

A		HEX	L	L1
G1/2	57SBIW21MPN	34	85	19
G3/4	57SBIW26MPN	34	85	16



Compact industrial coupling system in brass for use with numerous gaseous and liquid media. High Flow valve for optimum flow and low pressure drop.

- Available on request:
 - with additional end connections
 - other seals for different temperature ranges and fluids

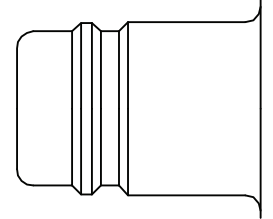

American Profile

KA Single Shut-Off

Working Pressure*:
up to 35 bar

Material:

- Coupling: Nickel plated brass
- Plug: Nickel Plated Brass
- Seals: NBR

Working Temperature:
-20°C up to +100°C (NBR)

Flow Rate Air:
7.500 l/min.
inlet pressure 6 bar, pressure drop 0.5 bar

Flow Rate Water:
96 l/min.
pressure drop 0.5 bar

KB Double Shut-Off

Working Pressure*:
up to 35 bar

Material:

- Coupling: Nickel plated brass
- Plug: Nickel Plated Brass
- Seals: NBR

Working Temperature:
-20°C up to +100°C (NBR)

Flow Rate Air:
2.150 l/min.
inlet pressure 6 bar, pressure drop 0.5 bar

Flow Rate Water:
27 l/min.
pressure drop 0.5 bar

* maximum static working pressure with design factor 4 to 1.

Single Shut-Off / Double Shut-off

38KBAW Coupler with valve, Male Thread

Nickel-plated brass, NBR

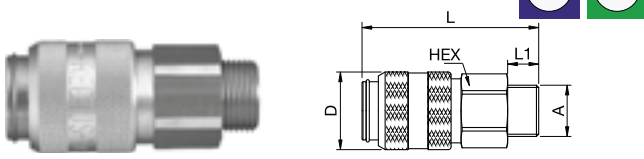

A	HEX	L	L1	D	
G1/2	38KBAW21MPN	34	89	12	40
G3/4	38KBAW26MPN	34	91	16	40
G1	38KBAW33MPN	41	91	19	40

Single Shut-Off / Double Shut-off

38KBTF Coupler with valve, Hose Barb

Nickel-plated brass, NBR

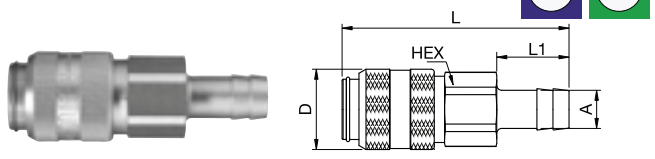

A	HEX	L	L1	D	
13	38KBTF13MPN	34	105	28	40
19	38KBTF19MPN	34	113	36	40

38KBIW Coupler with valve, Female Thread

Nickel-plated brass, NBR

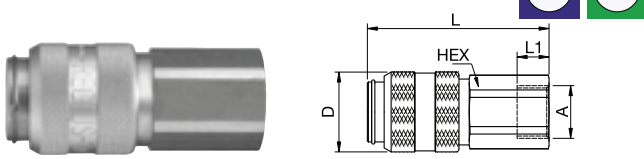

A	HEX	L	L1	D	
G1/2	38KBIW21MPN	34	95	20	40
G3/4	38KBIW26MPN	34	91	14	40
G1	38KBIW33MPN	41	92	20	40



Single Shut-Off

38SFAW Plug without valve, Male Thread

Nickel-plated brass

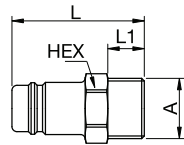

A		HEX	L	L1
G1/2	38SFAW21MXN	24	54	12
G3/4	38SFAW26MXN	27	58	16
G1	38SFAW33MXN	36	63	19

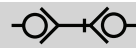

Double Shut-off

38SBAW Plug with valve, Male Thread

Nickel-plated brass, NBR

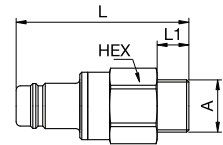
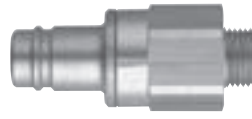

A		HEX	L	L1
G1/2	38SBAW21MPN	34	85	12
G3/4	38SBAW26MPN	34	87	16
G1	38SBAW33MPN	41	87	19

38SFIW Plug without valve, Female Thread

Nickel-plated brass

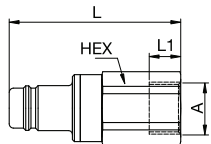

A		HEX	L	L1
G1/2	38SFIW21MXN	24	49	12
G3/4	38SFIW26MXN	30	54	18
G1	38SFIW33MXN	41	61	24

38SBIW Plug with valve, Female Thread

Nickel-plated brass, NBR

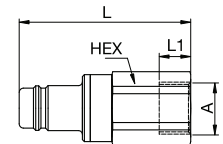

A		HEX	L	L1
G1/2	38SBIW21MPN	34	87	16
G3/4	38SBIW26MPN	34	87	16
G1	38SBIW33MPN	41	88	26

38SFTF Plug without valve, Hose Barb

Nickel-plated brass

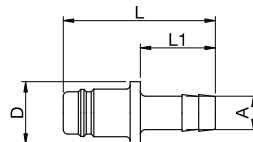
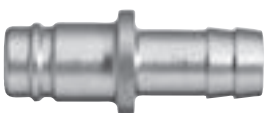

A		L	L1	D
13	38SFTF13MXN	65	28	30
19	38SFTF19MXN	73	36	30

38SBTF Plug with valve, Hose Barb

Nickel-plated brass, NBR

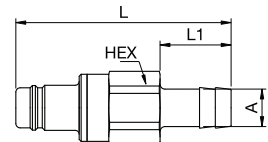

A		HEX	L	L1
13	38SBTF13MPN	34	103	28
19	38SBTF19MPN	34	109	36



Compact industrial coupling system in brass for use with numerous gaseous and liquid media. High Flow valve for optimum flow and low pressure drop.

- Available on request:
 - with additional end connections
 - other seals for different temperature ranges and fluids

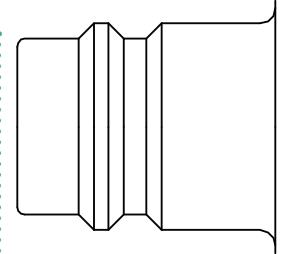

American Profile

KA Single Shut-Off

Working Pressure*:
up to 35 bar

Material:

- Coupling: Nickel plated brass
- Plug: Nickel plated brass
- Seals: NBR

Working Temperature:
-20°C up to +100°C (NBR)

Flow Rate Air:
9.000 l/min.
inlet pressure 6 bar, pressure drop 0.5 bar

Flow Rate Water:
125 l/min.
pressure drop 0.5 bar

KB Double Shut-Off

Working Pressure*:
up to 35 bar

Material:

- Coupling: Nickel plated brass
- Plug: Nickel plated brass
- Seals: NBR

Working Temperature:
-20°C up to +100°C (NBR)

Flow Rate Air:
3.000 l/min.
inlet pressure 6 bar, pressure drop 0.5 bar

Flow Rate Water:
33 l/min.
pressure drop 0.5 bar

KL Dry-break

Working Pressure*:
up to 8 bar

Material:

- Coupling: Nickel plated brass
- Plug: Nickel plated brass
- Seals: NBR

Working Temperature:
-20°C up to +100°C (NBR)

Flow Rate Water:
33 l/min.
pressure drop 0.5 bar

* maximum static working pressure with design factor 4 to 1.

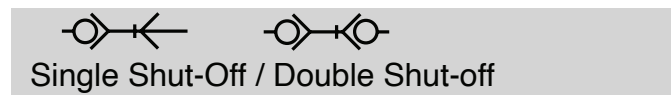
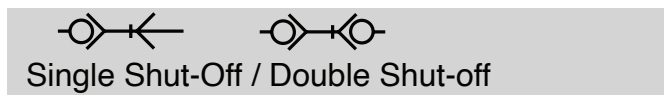

39KBAW Coupler with valve, Male Thread

Nickel-plated brass, NBR

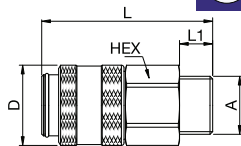
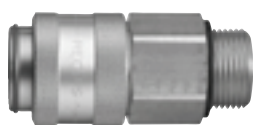

A	HEX	L	L1	D	
G3/4	39KBAW26MPN	41	95	16	46
G1	39KBAW33MPN	41	98	19	46

39KBTF Coupler with valve, Hose Barb

Nickel-plated brass, NBR

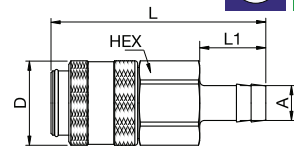

A	HEX	L	L1	D	
19	39KBTF19MPN	41	115	36	46
25	39KBTF25MPN	41	125	48	46

39KBIW Coupler with valve, Female Thread

Nickel-plated brass, NBR

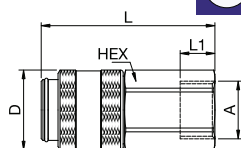

A	HEX	L	L1	D	
G3/4	39KBIW26MPN	41	99	20	46
G1	39KBIW33MPN	41	100	20	46



Single Shut-Off

39SFAW Plug without valve, Male Thread

Nickel-plated brass

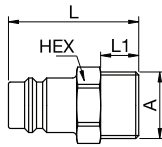

A	HEX	L	L1	
G3/4	39SFAW26MXN	30	60	16
G1	39SFAW33MXN	34	65	19

39SFIW Plug without valve, Female Thread

Nickel-plated brass

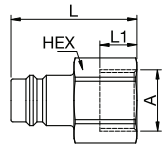

A	HEX	L	L1	
G1	39SFIW33MXN	41	68	24

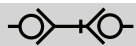

Double Shut-off

39SBAW Plug with valve, Male Thread

Nickel-plated brass, NBR

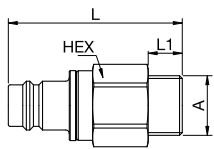

A	HEX	L	L1	
G3/4	39SBAW26MPN	41	92	16
G1	39SBAW33MPN	41	95	19

39SBIW Plug with valve, Female Thread

Nickel-plated brass, NBR

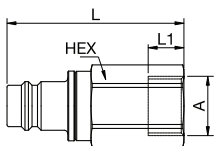

A	HEX	L	L1	
G3/4	39SBIW26MPN	41	96	19
G1	39SBIW33MPN	41	97	24



Double Shut-off

39SBTF Plug with valve, Hose Barb

Nickel-plated brass, NBR

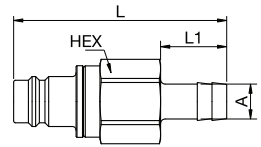

A	HEX	L	L1	
19	39SBTF19MPN	41	114	36
25	39SBTF25MPN	41	124	48



Dry-Break

39KLAW Coupler with valve, Male Thread

Nickel-plated brass, NBR

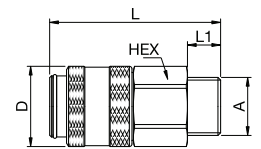

A	HEX	L	L1	D	
G3/4	39KLAW26MPN	41	95	16	46
G1	39KLAW33MPN	41	98	19	46

39KLIW Coupler with valve, Female Thread

Nickel-plated brass, NBR

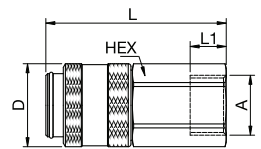
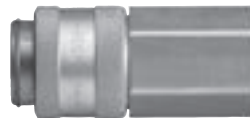

A	HEX	L	L1	D	
G3/4	39KLIW26MPN	41	99	20	46
G1	39KLIW33MPN	41	100	20	46

39KLTf Coupler with valve, Hose Barb

Nickel-plated brass, NBR

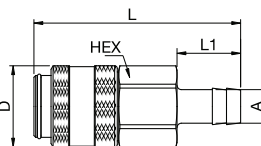

A	HEX	L	L1	D	
19	39KLTf19MPN	41	115	36	46
25	39KLTf25MPN	41	125	48	46



Dry-Break

39SLAW Plug with valve, Male Thread

Nickel-plated brass, NBR

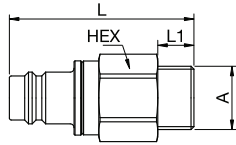

A

HEX L L1

G3/4	39SLAW26MPN	41	92	16
G1	39SLAW33MPN	41	95	19

39SLIW Plug with valve, Female Thread

Nickel-plated brass, NBR

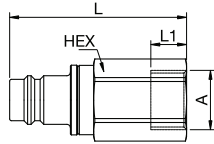

A

HEX L L1

G3/4	39SLIW26MPN	41	96	16
G1	39SLIW33MPN	41	97	24

39SLTF Plug with valve, Hose Barb

Nickel-plated brass, NBR

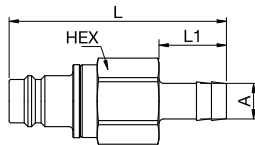

A

HEX L L1

19	39SLTF19MPN	41	114	36
25	39SLTF25MPN	41	124	48



Coupling series in sizes 1/8" to 1" with plug profile compliant with ISO 7241-1 series B. Particularly suited to use with liquid media. Coupling system with two-hand operation, i.e. both hands are required when coupling/uncoupling. The coupling series stands out for its high flow rates against a low pressure drop.

- Available on request:
 - other seals for different temperature ranges and fluids



ISO 7241-1 B Profile



Working Pressure*:
see table

Material:

- Coupling: Brass
- Plug: Brass
- Seals: NBR

Working Temperature:

-20°C up to +100°C (NBR)

Flow Rate Water:

- Series 71: 6 l/min.
- Series 72: 9 l/min.
- Series 73: 17 l/min.
- Series 74: 33 l/min.
- Series 75: 79 l/min.
- Series 76: 117 l/min.

pressure drop 0.5 bar

* maximum static working pressure with design factor 4 to 1.

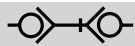

Double Shut-off

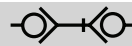

Double Shut-off

70KBIW Coupler with valve, Female Thread

Brass, NBR

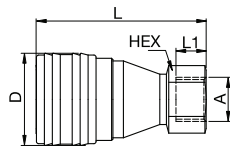

Size	A	Version	HEX	L	L1	D	Version	max. Working Pressure
1/8"	G1/8	71KBIW10MPX	14	48.5	7	25	Brass	250
1/8"	G1/8	71KBIW10MPN	14	48.5	7	25	Nickel-plated brass	250
1/4"	G1/4	72KBIW13MPX	19	57.5	10	25	Brass	200
1/4"	G1/4	72KBIW13MPN	19	57.5	10	25	Nickel-plated brass	200
3/8"	G3/8	73KBIW17MPX	22	64	11.5	35	Brass	200
3/8"	G3/8	73KBIW17MPN	22	64	11.5	35	Nickel-plated brass	200
1/2"	G1/2	74KBIW21MPX	27	76	16	44.5	Brass	150
1/2"	G1/2	74KBIW21MPN	27	76	16	44.5	Nickel-plated brass	150
3/4"	G3/4	75KBIW26MPX	34	96	24	55	Brass	100
3/4"	G3/4	75KBIW26MPN	34	96	24	55	Nickel-plated brass	100
1"	G1	76KBIW33MPX	41	105.5	24	62	Brass	100
1"	G1	76KBIW33MPN	41	105.5	24	62	Nickel-plated brass	100

70SBIW Plug with valve, Female Thread

Brass, NBR

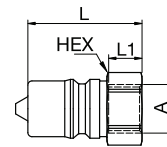

Size	A	Version	HEX	L	L1	D	Version	max. Working Pressure
1/8"	G1/8	71SBIW10MPX	14	29.5	7	25	Brass	250
1/8"	G1/8	71SBIW10MPN	14	29.5	7	25	Nickel-plated brass	250
1/4"	G1/4	72SBIW13MPX	19	35	10	25	Brass	200
1/4"	G1/4	72SBIW13MPN	19	35	10	25	Nickel-plated brass	200
3/8"	G3/8	73SBIW17MPX	22	39	11.5	35	Brass	200
3/8"	G3/8	73SBIW17MPN	22	39	11.5	35	Nickel-plated brass	200
1/2"	G1/2	74SBIW21MPX	27	48	16	44.5	Brass	150
1/2"	G1/2	74SBIW21MPN	27	48	16	44.5	Nickel-plated brass	150
3/4"	G3/4	75SBIW26MPX	36	60	24	55	Brass	100
3/4"	G3/4	75SBIW26MPN	36	60	24	55	Nickel-plated brass	100
1"	G1	76SBIW33MPX	41	65	24	62	Brass	100
1"	G1	76SBIW33MPN	41	65	24	62	Nickel-plated brass	100



Mini industrial coupling with internationally used profile. Frequent use in medical technology and chemistry/pharmacy. Coupling system with single-hand operation. High flow despite small dimensions. Wide range of applications with different media.

- Available on request:
 - with additional end connections
 - other seals for different temperature ranges and fluids



Euro Profile

KA Single Shut-Off

Working Pressure*:
up to 35 bar

Material:

- Coupling: AISI 303 / AISI 316 L
- Plug: AISI 303 / AISI 316 L
- Seals: FKM

Working Temperature:
-15°C up to +200°C (FKM)

Flow Rate Air:
165 l/min.
inlet pressure 6 bar, pressure drop 0.5 bar

Flow Rate Air:
1.5 l/min.
pressure drop 0.5 bar

KB Double Shut-Off

Working Pressure*:
up to 35 bar

Material:

- Coupling: AISI 303 / AISI 316 L
- Plug: AISI 303 / AISI 316 L
- Seals: FKM

Working Temperature:
-15°C up to +200°C (FKM)

Flow Rate Air:
130 l/min.
inlet pressure 6 bar, pressure drop 0.5 bar

Flow Rate Air:
1.2 l/min.
pressure drop 0.5 bar

* maximum static working pressure with design factor 4 to 1.

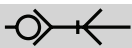

Single Shut-Off

20KAA Coupler with valve, Male Thread

Stainless Steel, FKM

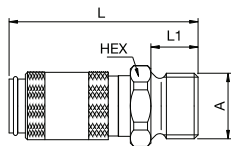

A	Version	HEX	L	L1	D	Version
M5	20KAAM05RVX	9	26	5	10	AISI 303
M5	20KAAM05EVX	9	26	5	10	AISI 316L
G1/8	20KAAW10RVX	11	28	7	10	AISI 303
G1/8	20KAAW10EVX	11	28	7	10	AISI 316L

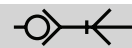

Single Shut-Off

20KATF Coupler with valve, Hose Barb

Stainless Steel, FKM

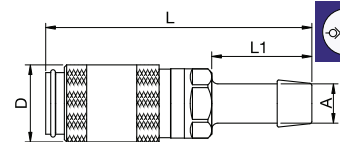

A	Version	L	L1	D	Version
4	20KATF04RVX	35	13	10	AISI 303
4	20KATF04EVX	35	13	10	AISI 316L
5	20KATF05RVX	35	13	10	AISI 303

20KAKO Coupler with valve, with Plastic Hose Connection

Stainless Steel, FKM

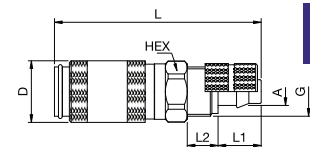

A	Version	HEX	G	L	L1	L2	D	Version
3 x 4	20KAKO04RVX	9	M7x0.5	34	7	5	10	AISI 303
3 x 4	20KAKO04EVX	9	M7x0.5	34	7	5	10	AISI 316L
3 x 5	20KAKO05RVX	9	M7x0.5	34	7	5	10	AISI 303
3 x 5	20KAKO05EVX	9	M7x0.5	34	7	5	10	AISI 316L
4 x 6	20KAKO06RVX	9	M8x0.5	34	7	5	10	AISI 303
4 x 6	20KAKO06EVX	9	M8x0.5	34	7	5	10	AISI 316L

20KAI Coupler with valve, Female Thread

Stainless Steel, FKM

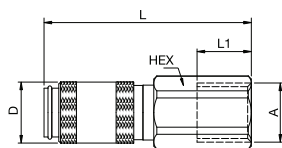

A	Version	HEX	L	L1	D	Version
M5	20KAIM05RVX	9	25	5	10	AISI 303
M5	20KAIM05EVX	9	25	5	10	AISI 316L
G1/8	20KAIW10RVX	12	28	7	10	AISI 303
G1/8	20KAIW10EVX	12	28	7	10	AISI 316L

Series 20 - Stainless Steel



Single Shut-Off

20KAKS Coupler with valve, Panel Mount with Plastic Hose Connection

Stainless Steel AISI 303, FKM

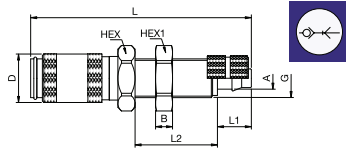

A	HEX	HEX1	B	G	L	L1	L2	D	
3 x 4	20KAKS04RVX	12	11	3	M7x0.5	45	7	17	10
3 x 5	20KAKS05RVX	12	11	3	M7x0.5	45	7	17	10
4 x 6	20KAKS06RVX	12	11	3	M8x0.5	45	7	17	10

20SFA Plug without valve, Male Thread

Stainless Steel

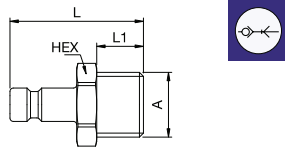

A	HEX	L	L1	Version
M5	20SFAM05RXX	7	18	AISI 303
M5	20SFAM05EXX	7	18	AISI 316L
G1/8	20SFAW10RXX	11	20	AISI 303
G1/8	20SFAW10EXX	11	20	AISI 316L

20SFI Plug without valve, Female Thread

Stainless Steel

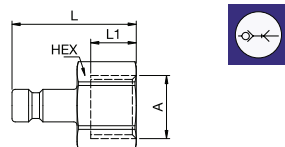

A	HEX	L	L1	Version
M5	20SFIM05RXX	7	17	AISI 303
M5	20SFIM05EXX	7	17	AISI 316L
G1/8	20SFIW10RXX	12	19	AISI 303
G1/8	20SFIW10EXX	12	19	AISI 316L

20SFTF Plug without valve, Hose Barb

Stainless Steel

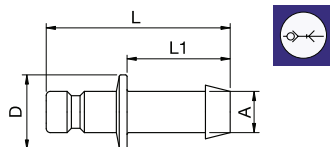

A	L	L1	D	Version
4	20SFTF04RXX	24	13	AISI 303
4	20SFTF04EXX	24	13	AISI 316L
5	20SFTF05RXX	22	13	AISI 303



Single Shut-Off

20SFKO Plug without valve, with Plastic Hose Connection

Stainless Steel

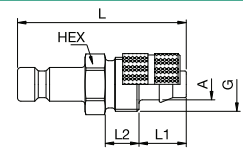

A	HEX	G	L	L1	L2	Version	
3 x 4	20SFK004RXX	8	M7x0.5	25	7	5	AISI 303
3 x 4	20SFK004EXX	8	M7x0.5	25	7	5	AISI 316L
3 x 5	20SFK005RXX	8	M7x0.5	25	7	5	AISI 303
3 x 5	20SFK005EXX	8	M7x0.5	25	7	5	AISI 316L
4 x 6	20SFK006RXX	8	M8x0.5	25	7	5	AISI 303
4 x 6	20SFK006EXX	8	M8x0.5	25	7	5	AISI 316L

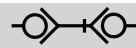

Double Shut-off

20KBA Coupler with valve, Male Thread

Stainless Steel, FKM

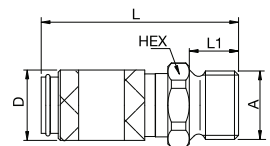

A	HEX	L	L1	D	Version		
M5	20KBAM05RVX	9	26	5	10	AISI 303	
M5	20KBAM05EVX	9201X20 19	9	26	5	10	AISI 316L
G1/8	20KBAW10RVX	11	28	7	10	AISI 303	
G1/8	20KBAW10EVX	9201X20 10	11	28	7	10	AISI 316L

20KBI Coupler with valve, Female Thread

Stainless Steel, FKM

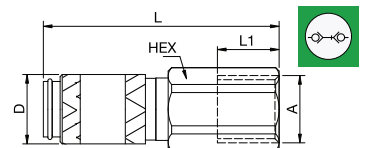

A	HEX	L	L1	D	Version		
M5	20KBIM05RVX	9	25	5	10	AISI 303	
M5	20KBIM05EVX	9214X20 19	9	25	5	10	AISI 316L
G1/8	20KBIW10RVX	12	28	7	10	AISI 303	
G1/8	20KBIW10EVX	9214X20 10	12	28	7	10	AISI 316L

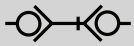

Double Shut-off

20KBTF Coupler with valve, Hose Barb

Stainless Steel, FKM

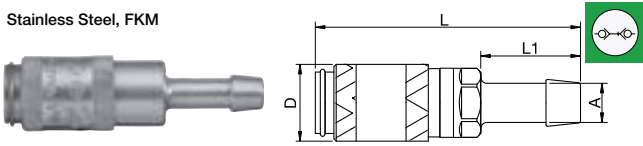

A		L	L1	D	Version
4	20KBTFO4RVX	35	13	10	AISI 303
4	20KBTFO4EVX	35	13	10	AISI 316L
5	20KBTFO5RVX	35	13	10	AISI 303

20KCKO Coupler with valve, with Plastic Hose Connection

Stainless Steel, FKM

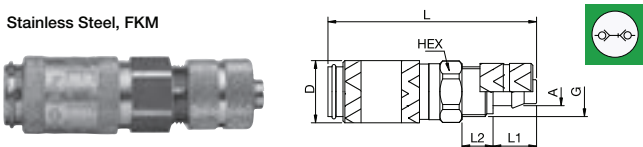

A		HEX	G	L	L1	L2	D	Version
3 x 4	20KCKO04RVX	9	M7x0.5	34	7	5	10	AISI 303
3 x 4	20KCKO04EVX	9	M7x0.5	34	7	5	10	AISI 316L
3 x 5	20KCKO05RVX	9	M7x0.5	34	7	5	10	AISI 303
3 x 5	20KCKO05EVX	9	M7x0.5	34	7	5	10	AISI 316L
4 x 6	20KCKO06RVX	9	M8x0.5	34	7	5	10	AISI 303
4 x 6	20KCKO06EVX	9	M8x0.5	34	7	5	10	AISI 316L

20KCKS Coupler with valve, Panel Mount with Plastic Hose Connection

Stainless Steel AISI 303, FKM

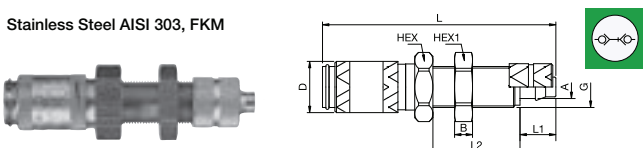

A		HEX	HEX1	B	G	L	L1	L2	D
3 x 4	20KCKS04RVX	12	11	3	M7x0.5	45	7	17	10
3 x 5	20KCKS05RVX	12	11	3	M7x0.5	45	7	17	10
4 x 6	20KCKS06RVX	12	12	3.5	M8x0.5	45	7	17	10

20SBA Plug with valve, Male Thread

Stainless Steel, FKM

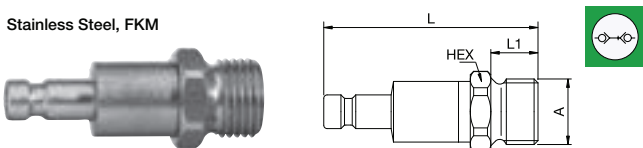

A		HEX	L	L1	Version
M5	20SBAM05RVX	9	28	5	AISI 303
M5	20SBAM05EVX	9	28	5	AISI 316L
G1/8	20SBAW10RVX	11	30	7	AISI 303
G1/8	20SBAW10EVX	11	30	7	AISI 316L

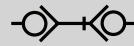

Double Shut-off

20SBI Plug with valve, Female Thread

Stainless Steel, FKM

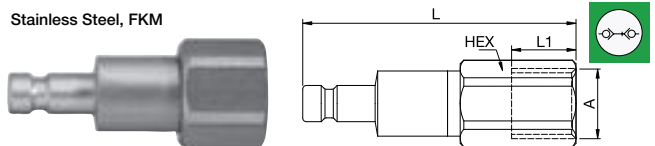

A		HEX	L	L1	Version
M5	20SBIM05RVX	9	27	5	AISI 303
M5	20SBIM05EVX	9	27	5	AISI 316L
G1/8	20SBIW10RVX	12	30	7	AISI 303
G1/8	20SBIW10EVX	12	30	7	AISI 316L

20SBTF Plug with valve, Hose Barb

Stainless Steel, FKM

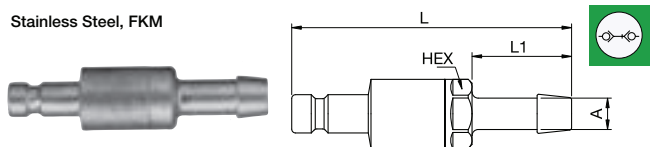

A		HEX	L	L1	Version
4	20SBTF04RVX	8	37	13	AISI 303
4	20SBTF04EVX	8	37	13	AISI 316L
5	20SBTF05RVX	8	37	13	AISI 303

20SBKO Plug with valve, with Plastic Hose Connection

Stainless Steel, FKM

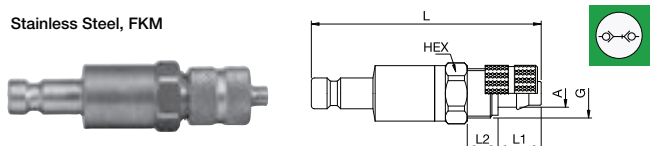

A		HEX	G	L	L1	L2	Version
3 x 4	20SBKO04RVX	9	M7x0.5	36	7	5	AISI 303
3 x 4	20SBKO04EVX	9	M7x0.5	36	7	5	AISI 316L
3 x 5	20SBKO05RVX	9	M7x0.5	36	7	5	AISI 303
3 x 5	20SBKO05EVX	9	M7x0.5	36	7	5	AISI 316L
4 x 6	20SBKO06RVX	9	M8x0.5	36	7	5	AISI 303
4 x 6	20SBKO06EVX	9	M8x0.5	36	7	5	AISI 316L

20SBKS Plug with valve, Panel Mount with Plastic Hose Connection

Stainless Steel AISI 303, FKM

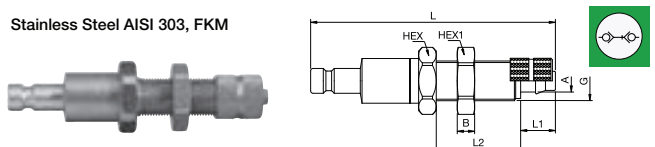

A		HEX	HEX1	B	G	L	L1	L2
3 x 4	20SBKS04RVX	12	11	3	M7x0.5	47	7	17
3 x 5	20SBKS05RVX	12	11	3	M7x0.5	47	7	17
4 x 6	20SBKS06RVX	12	12	3.5	M8x0.5	47	7	17



Mini industrial coupling with plug profile according to ISO 6150 C. Popular profile in analytical and medical technology. Above average flow rate performance for liquid and gaseous media.

- Available on request:
 - with additional end connections
 - other seals for different temperature ranges and fluids

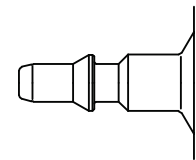

ISO C Profile

KB Double Shut-Off

Working Pressure*:
up to 35 bar

Material:

- Coupling: AISI 316 L
- Plug: AISI 316 L
- Seals: FKM

Working Temperature:
-15°C up to +200°C (FKM)

Flow Rate Air:
160 l/min.
inlet pressure 6 bar, pressure drop 0.5 bar

Flow Rate Air:
2.2 l/min.
pressure drop 0.5 bar

* maximum static working pressure with design factor 4 to 1.

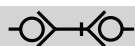

Double Shut-off

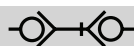

Double Shut-off

303KBAW Coupler with valve, Male Thread

Stainless Steel AISI 316 L, FKM

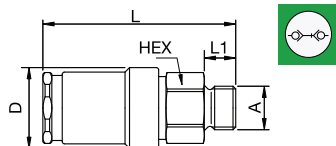

A 

	HEX	L	L1	D
G1/8 303KBAW10EVX	14	43	7	18
G1/4 303KBAW13EVX	17	45	9	18

303KBKO Coupler with valve, with Plastic Hose Connection

Stainless Steel AISI 316 L, FKM

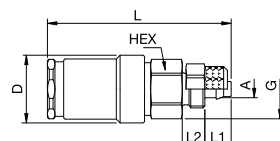

A 

	HEX	G	L	L1	L2	D
4 x 6 303KBK006EVX	14	M10x1	49	7	6	18
6 x 8 303KBK008EVX	14	M12x1	49	7	6	18

303KBIW Coupler with valve, Female Thread

Stainless Steel AISI 316 L, FKM

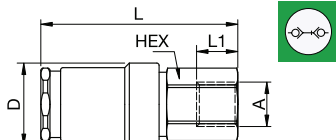

A 

	HEX	L	L1	D
G1/8 303KBIW10EVX	14	43	9	18
G1/4 303KBIW13EVX	17	45	9	18

303SBAW Plug with valve, Male Thread

Stainless Steel AISI 316 L, FKM

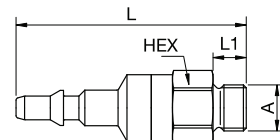

A 

	HEX	L	L1
G1/8 303SBAW10EVX	14	48.5	7
G1/4 303SBAW13EVX	17	50.5	9

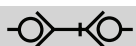

Double Shut-off

303SBIW Plug with valve, Female Thread

Stainless Steel AISI 316 L, FKM

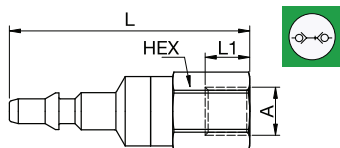

A		HEX	L	L1
G1/8	303SBIW10EVX	14	48.5	9
G1/4	303SBIW13EVX	17	50.5	9

303SBKO Plug with valve, with Plastic Hose Connection

Stainless Steel AISI 316 L, FKM

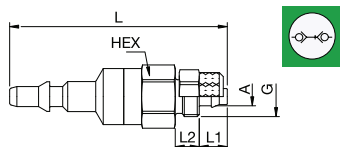

A		HEX	G	L	L1	L2
4 x 6	303SBK006EVX	14	M10x1	54.5	7	6
6 x 8	303SBK008EVX	14	M12x1	54.5	7	6



Mini industrial coupling with the world's most popular profile in this nominal diameter. Above average flow performance for liquid and gaseous media. Coupling system with single-hand operation. Small dimensions and large bandwidth in materials and valve variants.

- Available on request:
 - with additional end connections
 - other seals for different temperature ranges and fluids

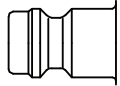

Euro Profile

Dust Protections  (P. 357)
for Coupling Part.-No. SK16S

 **KA** Single Shut-Off

Working Pressure*:
up to 35 bar

Material:

- Coupling: AISI 303 / AISI 316 L
- Plug: AISI 303 / AISI 316 L
- Seals: FKM

Working Temperature:
-15°C up to +200°C (FKM)

Flow Rate Air:
550 l/min.
inlet pressure 6 bar, pressure drop 0.5 bar

Flow Rate Water:
7 l/min.
pressure drop 0.5 bar

 **KB** Double Shut-Off

Working Pressure*:
up to 35 bar

Material:

- Coupling: AISI 303 / AISI 316 L
- Plug: AISI 303 / AISI 316 L
- Seals: FKM

Working Temperature:
-15°C up to +200°C (FKM)

Flow Rate Air:
310 l/min.
inlet pressure 6 bar, pressure drop 0.5 bar

Flow Rate Water:
2.7 l/min.
pressure drop 0.5 bar

* maximum static working pressure with design factor 4 to 1.

 Single Shut-Off

 Single Shut-Off

21KAAW Coupler with valve, Male Thread

Stainless Steel, FKM

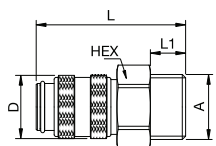

A	Version	HEX	L	L1	D	Version
G1/8	21KAAW10RVX	14	36	7	16	AISI 303
G1/8	21KAAW10EVX	14	36	7	16	AISI 316L
G1/4	21KAAW13RVX	17	38	9	16	AISI 303
G1/4	21KAAW13EVX	17	38	9	16	AISI 316L
G3/8	21KAAW17RVX	19	38	9	16	AISI 303
G3/8	21KAAW17EVX	19	38	9	16	AISI 316L

21KAIW Coupler with valve, Female Thread

Stainless Steel, FKM

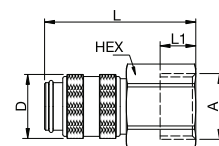

A	Version	HEX	L	L1	D	Version
G1/8	21KAIW10RVX	14	36	9	16	AISI 303
G1/8	21KAIW10EVX	14	36	9	16	AISI 316L
G1/4	21KAIW13RVX	17	38	9	16	AISI 303
G1/4	21KAIW13EVX	17	38	9	16	AISI 316L
G3/8	21KAIW17RVX	19	38	9	16	AISI 303
G3/8	21KAIW17EVX	19	38	9	16	AISI 316L

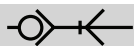

Single Shut-Off

21KATF Coupler with valve, Hose Barb

Stainless Steel, FKM

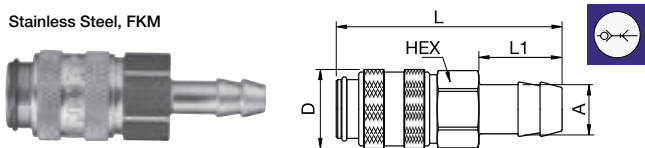

A		HEX	L	L1	D	Version
6	21KATF06RVX	14	46	17	16	AISI 303
6	21KATF06EVX	14	46	17	16	AISI 316L
8	21KATF08RVX	14	46	17	16	AISI 303
8	21KATF08EVX	14	46	17	16	AISI 316L
9	21KATF09RVX	14	46	17	16	AISI 303
9	21KATF09EVX	14	46	17	16	AISI 316L
10	21KATF10RVX	14	46	17	16	AISI 303
10	21KATF10EVX	14	46	17	16	AISI 316L

21KAKO Coupler with valve, with Plastic Hose Connection

Stainless Steel, FKM

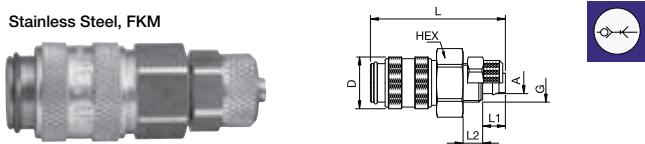

A		HEX	G	L	L1	L2	D	Version
4 x 6	21KAKO06RVX	14	M10x1	42	7	6	16	AISI 303
4 x 6	21KAKO06EVX	14	M10x1	42	7	6	16	AISI 316L
6 x 8	21KAKO08RVX	14	M12x1	42	7	6	16	AISI 303
6 x 8	21KAKO08EVX	14	M12x1	42	7	6	16	AISI 316L

21SAFW Plug without valve, Male Thread

Stainless Steel

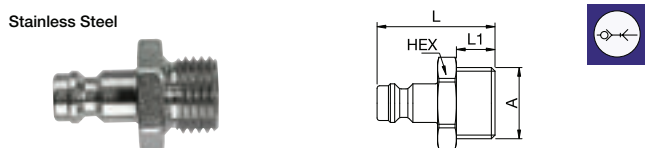

A		HEX	L	L1	Version
G1/8	21SAFW10RXX	14	25	7	AISI 303
G1/8	21SAFW10EXX	9087X21 10	14	25	AISI 316L
G1/4	21SAFW13RXX	17	28	9	AISI 303
G1/4	21SAFW13EXX	9087X21 13	17	28	AISI 316L
G3/8	21SAFW17RXX	19	28	9	AISI 303

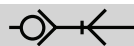

Single Shut-Off

21SFIW Plug without valve, Female Thread

Stainless Steel

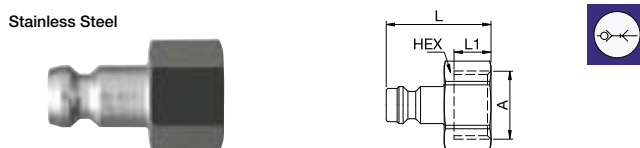

A		HEX	L	L1	Version
G1/8	21SFIW10RXX	14	25	8	AISI 303
G1/8	21SFIW10EXX	9086X21 10	14	25	AISI 316L
G1/4	21SFIW13RXX	17	25	9	AISI 303
G1/4	21SFIW13EXX	9086X21 13	17	25	AISI 316L
G3/8	21SFIW17RXX	19	26	9	AISI 303

21SFTF Plug without valve, Hose Barb

Stainless Steel

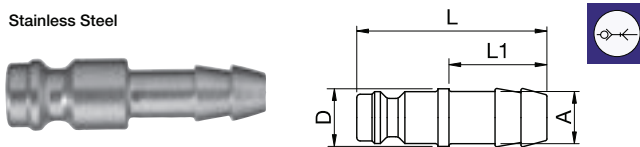

A		L	L1	D	Version
6	21SFTF06RXX	32	17	9	AISI 303
6	21SFTF06EXX	32	17	9	AISI 316L
8	21SFTF08RXX	32	17	9	AISI 303
8	21SFTF08EXX	32	17	9	AISI 316L
9	21SFTF09RXX	33	17	10	AISI 303
9	21SFTF09EXX	33	17	10	AISI 316L
10	21SFTF10RXX	33	17	12	AISI 303
10	21SFTF10EXX	33	17	12	AISI 316L

21SFKO Plug without valve, with Plastic Hose Connection

Stainless Steel

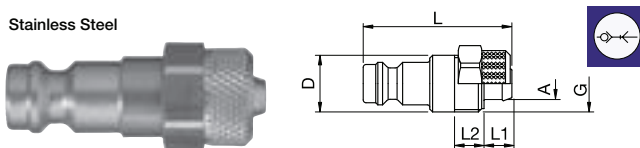

A		HEX	HEX1	G	L	L1	L2	D	Version
4 x 6	21SFKO06RXX	12	12	M10x1	32	7	6	10	AISI 303
4 x 6	21SFKO06EXX	12	12	M10x1	32	7	6	10	AISI 316L
6 x 8	21SFKO08RXX	14	14	M12x1	32	7	6	12	AISI 303
6 x 8	21SFKO08EXX	14	14	M12x1	32	7	6	12	AISI 316L

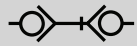

Double Shut-off

21KBAW Coupler with valve, Male Thread

Stainless Steel, FKM

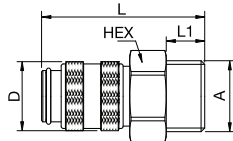

A			HEX	L	L1	D	Version
G1/8			14	36	7	16	AISI 303
G1/8			14	36	7	16	AISI 316L
G1/4			17	38	9	16	AISI 303
G1/4			17	38	9	16	AISI 316L
G3/8			19	38	9	16	AISI 303
G3/8			19	38	9	16	AISI 316L

21KBIW Coupler with valve, Female Thread

Stainless Steel, FKM

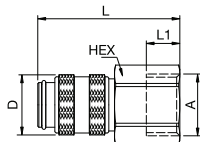

A			HEX	L	L1	D	Version
G1/8			14	36	9	16	AISI 303
G1/8			14	36	9	16	AISI 316L
G1/4			17	38	7	16	AISI 303
G1/4			17	38	7	16	AISI 316L
G3/8			19	38	9	16	AISI 303
G3/8			19	38	9	16	AISI 316L

21KBTF Coupler with valve, Hose Barb

Stainless Steel, FKM

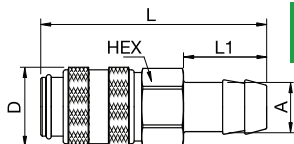

A			HEX	L	L1	D	Version
6			14	46	17	16	AISI 303
6			14	46	17	16	AISI 316L
8			14	46	17	16	AISI 303
8			14	46	17	16	AISI 316L
9			14	46	17	16	AISI 303
9			14	46	17	16	AISI 316L
10			14	46	17	16	AISI 303
10			14	46	17	16	AISI 316L

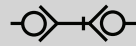

Double Shut-off

21KBKO Coupler with valve, with Plastic Hose Connection

Stainless Steel, FKM

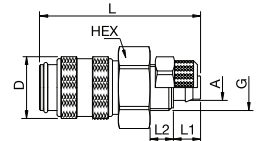

A			HEX	G	L	L1	L2	D	Version
4 x 6			14	M10x1	42	7	6	16	AISI 303
4 x 6			14	M10x1	42	7	6	16	AISI 316L
6 x 8			14	M12x1	42	7	6	16	AISI 303
6 x 8			14	M12x1	42	7	6	16	AISI 316L

21SBAW Plug with valve, Male Thread

Stainless Steel, FKM

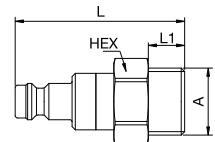
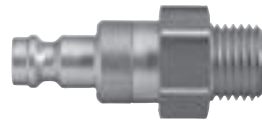

A			HEX	L	L1	Version
G1/8			14	40	7	AISI 303
G1/8			14	40	7	AISI 316L
G1/4			17	42	9	AISI 303
G1/4			17	42	9	AISI 316L
G3/8			19	42	9	AISI 303
G3/8			19	42	9	AISI 316L

21SBIW Plug with valve, Female Thread

Stainless Steel, FKM

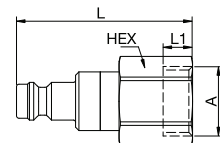
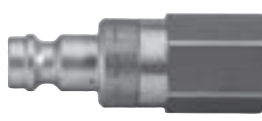

A			HEX	L	L1	Version
G1/8			14	40	9	AISI 303
G1/8			14	40	9	AISI 316L
G1/4			17	42	7	AISI 303
G1/4			17	42	7	AISI 316L
G3/8			19	42	9	AISI 303
G3/8			19	42	9	AISI 316L

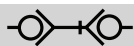

Double Shut-off

21SBTF Plug with valve, Hose Barb

Stainless Steel, FKM

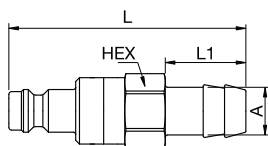

A		HEX	L	L1	Version
6	21SBTF06RVX	14	50	17	AISI 303
6	21SBTF06EVX	14	50	17	AISI 316L
8	21SBTF08RVX	14	50	17	AISI 303
8	21SBTF08EVX	14	50	17	AISI 316L
9	21SBTF09RVX	14	50	17	AISI 303
9	21SBTF09EVX	14	50	17	AISI 316L
10	21SBTF10RVX	14	50	17	AISI 303
10	21SBTF10EVX	14	50	17	AISI 316L

21SBKO Plug with valve, with Plastic Hose Connection

Stainless Steel, FKM

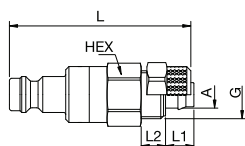

A		HEX	G	L	L1	L2	Version
4 x 6	21SBK006RVX	14	M10x1	46	7	6	AISI 303
4 x 6	21SBK006EVX	14	M10x1	46	7	6	AISI 316L
6 x 8	21SBK008RVX	14	M12x1	46	7	6	AISI 303
6 x 8	21SBK008EVX	14	M12x1	46	7	6	AISI 316L



Universal industrial coupling with standard European profile for use with gaseous, liquid and aggressive media. Coupling system with single-hand operation. High Flow valve for optimum flow and low pressure drop. The series stands out for its robust design and long service life even with the harshest use. The collar design minimises damage to the valve body.

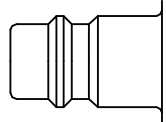

Euro Profile

- Available on request:
 - with additional end connections
 - other seals for different temperature ranges and fluids

Dust Protections (P. 357)
for Coupling Part.-No. SK23S
for Plug Part.-No. SK12S

KA Single Shut-Off

Working Pressure*:
up to 35 bar

Material:

- Coupling: AISI 303 / AISI 316 L
- Plug: AISI 303 / AISI 316 L
- Seals: FKM

Working Temperature:
-15°C up to +200°C (FKM)

Flow Rate Air:
1.800 l/min.
inlet pressure 6 bar, pressure drop 0.5 bar

Flow Rate Water:
28 l/min.
pressure drop 0.5 bar

KB Double Shut-Off

Working Pressure*:
up to 35 bar

Material:

- Coupling: AISI 303 / AISI 316 L
- Plug: AISI 303 / AISI 316 L
- Seals: FKM

Working Temperature:
-15°C up to +200°C (FKM)

Flow Rate Air:
710 l/min.
inlet pressure 6 bar, pressure drop 0.5 bar

Flow Rate Water:
7.1 l/min.
pressure drop 0.5 bar

* maximum static working pressure with design factor 4 to 1.

Single Shut-Off

Single Shut-Off

25KA AW Coupler with valve, Male Thread

Stainless Steel, FKM

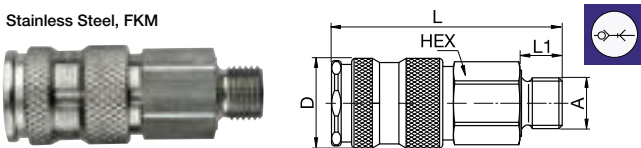

A	Version	HEX	L	L1	D	Version
G1/4	25KA AW13RVX	19	60	10.5	23	AISI 303
G1/4	25KA AW13EVX	19	60	10.5	23	AISI 316L
G3/8	25KA AW17RVX	19	58	9	23	AISI 303
G3/8	25KA AW17EVX	19	58	9	23	AISI 316L
G1/2	25KA AW21RVX	24	61	12	23	AISI 303
G1/2	25KA AW21EVX	24	61	12	23	AISI 316L

25KA IW Coupler with valve, Female Thread

Stainless Steel, FKM

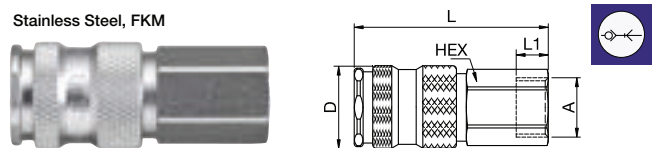

A	Version	HEX	L	L1	D	Version
G1/4	25KA IW13RVX	19	56	10	23	AISI 303
G1/4	25KA IW13EVX	19	56	10	23	AISI 316L
G3/8	25KA IW17RVX	19	55	9	23	AISI 303
G3/8	25KA IW17EVX	19	55	9	23	AISI 316L
G1/2	25KA IW21RVX	24	58	12	23	AISI 303
G1/2	25KA IW21EVX	24	58	12	23	AISI 316L

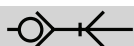

Single Shut-Off

25KATF Coupler with valve, Hose Barb

Stainless Steel, FKM

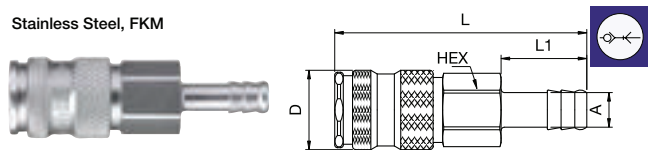

A		HEX	L	L1	D	Version
6	25KATF06RVX	19	74	25	23	AISI 303
6	25KATF06EVX	19	74	25	23	AISI 316L
8	25KATF08RVX	19	74	25	23	AISI 303
8	25KATF08EVX	19	74	25	23	AISI 316L
9	25KATF09RVX	19	74	25	23	AISI 303
9	25KATF09EVX	19	74	25	23	AISI 316L
10	25KATF10RVX	19	74	25	23	AISI 303
10	25KATF10EVX	19	74	25	23	AISI 316L
13	25KATF13RVX	19	74	25	23	AISI 303
13	25KATF13EVX	19	74	25	23	AISI 316L

25SFAW Plug without valve, Male Thread

Stainless Steel

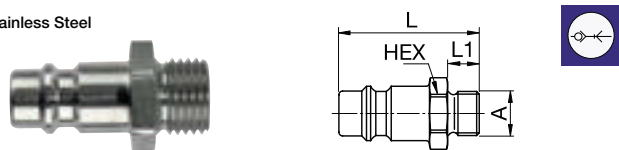

A		HEX	L	L1	Version
G1/8	25SFAW10RXX	14	31	7	AISI 303
G1/4	25SFAW13RXX	17	33	9	AISI 303
G1/4	25SFAW13EXX	17	33	9	AISI 316L
G3/8	25SFAW17RXX	19	33	9	AISI 303
G3/8	25SFAW17EXX	19	33	9	AISI 316L
G1/2	25SFAW21RXX	24	38	12	AISI 303
G1/2	25SFAW21EXX	9087X25 21	24	38	AISI 316L

25SFIW Plug without valve, Female Thread

Stainless Steel

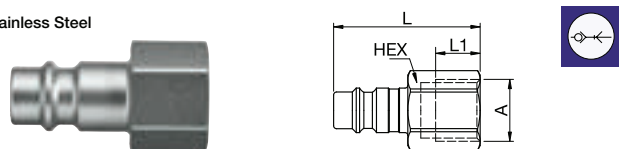

A		HEX	L	L1	Version
G1/8	25SFIW10RXX	14	30	7	AISI 303
G1/4	25SFIW13RXX	17	33	10	AISI 303
G1/4	25SFIW13EXX	9086X25 13	17	33	AISI 316L
G3/8	25SFIW17RXX	19	33	10	AISI 303
G3/8	25SFIW17EXX	9086X25 17	19	33	AISI 316L
G1/2	25SFIW21RXX	24	35	12	AISI 303
G1/2	25SFIW21EXX	24	35	12	AISI 316L

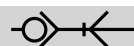

Single Shut-Off

25SFTF Plug without valve, Hose Barb

Stainless Steel

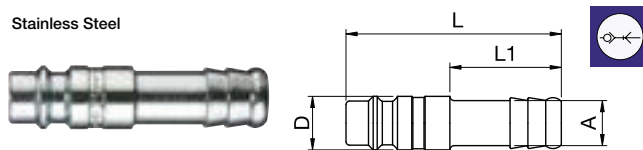

A		L	L1	D	Version
6	25SFTF06RXX	48	25	12	AISI 303
6	25SFTF06EXX	48	25	12	AISI 316L
8	25SFTF08RXX	48	25	12	AISI 303
8	25SFTF08EXX	48	25	12	AISI 316L
9	25SFTF09RXX	48	25	12	AISI 303
9	25SFTF09EXX	48	25	12	AISI 316L
10	25SFTF10RXX	48	25	12	AISI 303
10	25SFTF10EXX	48	25	12	AISI 316L
13	25SFTF13RXX	48	25	15	AISI 303
13	25SFTF13EXX	48	25	15	AISI 316L



Double Shut-off

25KBAW Coupler with valve, Male Thread

Stainless Steel, FKM

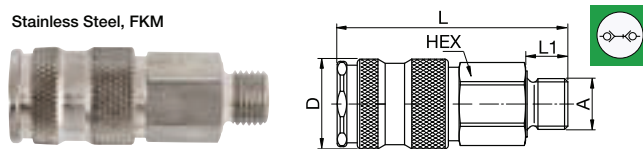

A		HEX	L	L1	D	Version
G1/4	25KBAW13RVX	19	60	10.5	23	AISI 303
G1/4	25KBAW13EVX	9201X25 13	19	60	10.5	AISI 316L
G3/8	25KBAW17RVX	19	58	9	23	AISI 303
G3/8	25KBAW17EVX	9201X25 17	19	58	9	AISI 316L
G1/2	25KBAW21RVX	24	61	12	23	AISI 303
G1/2	25KBAW21EVX	9201X25 21	24	61	12	AISI 316L

25KBIW Coupler with valve, Female Thread

Stainless Steel, FKM

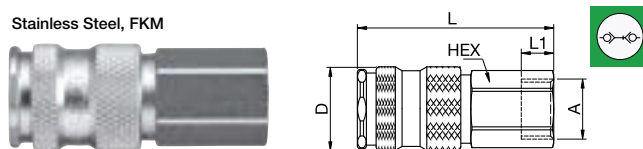

A		HEX	L	L1	D	Version
G1/4	25KBIW13RVX	19	56	10	23	AISI 303
G1/4	25KBIW13EVX	9214X25 13	19	56	10	AISI 316L
G3/8	25KBIW17RVX	19	55	9	23	AISI 303
G3/8	25KBIW17EVX	9214X25 17	19	55	9	AISI 316L
G1/2	25KBIW21RVX	24	58	12	23	AISI 303
G1/2	25KBIW21EVX	9214X25 21	24	58	12	AISI 316L

Series 25 - Stainless Steel

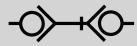

Double Shut-off

25KBT Coupler with valve, Hose Barb

Stainless Steel, FKM

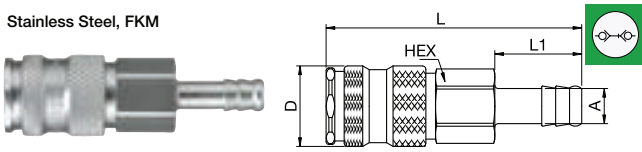

A		HEX	L	L1	D	Version
6	25KBTf06RVX	19	74	25	23	AISI 303
6	25KBTf06EVX	19	74	25	23	AISI 316L
8	25KBTf08RVX	19	74	25	23	AISI 303
8	25KBTf08EVX	19	74	25	23	AISI 316L
9	25KBTf09RVX	19	74	25	23	AISI 303
9	25KBTf09EVX	19	74	25	23	AISI 316L
10	25KBTf10RVX	19	74	25	23	AISI 303
10	25KBTf10EVX	19	74	25	23	AISI 316L
13	25KBTf13RVX	19	74	25	23	AISI 303
13	25KBTf13EVX	19	74	25	23	AISI 316L

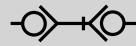

Double Shut-off

25SBTF Plug with valve, Hose Barb

Stainless Steel, FKM

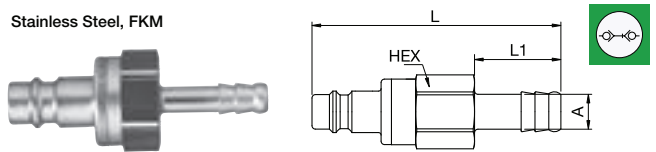

A		HEX	L	L1	Version
6	25SBTF06RVX	19	72	25	AISI 303
6	25SBTF06EVX	19	72	25	AISI 316L
8	25SBTF08RVX	19	72	25	AISI 303
8	25SBTF08EVX	19	72	25	AISI 316L
9	25SBTF09RVX	19	72	25	AISI 303
9	25SBTF09EVX	19	72	25	AISI 316L
10	25SBTF10RVX	19	72	25	AISI 303
10	25SBTF10EVX	19	72	25	AISI 316L
13	25SBTF13RVX	19	72	25	AISI 303
13	25SBTF13EVX	19	72	25	AISI 316L

25SBAW Plug with valve, Male Thread

Stainless Steel, FKM

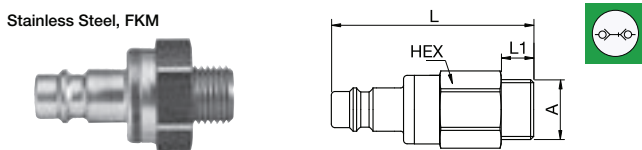

A		HEX	L	L1	Version	
G1/4	25SBAW13RVX	19	58	10.5	AISI 303	
G1/4	25SBAW13EVX	9287X25 13	19	58	10.5	AISI 316L
G3/8	25SBAW17RVX	19	56	9	AISI 303	
G3/8	25SBAW17EVX	9287X25 17	19	56	9	AISI 316L
G1/2	25SBAW21RVX	24	59	12	AISI 303	
G1/2	25SBAW21EVX	9287X25 21	24	59	12	AISI 316L

25SBIW Plug with valve, Female Thread

Stainless Steel, FKM

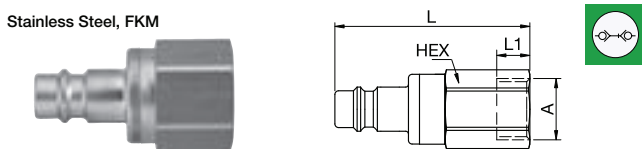

A		HEX	L	L1	Version	
G1/4	25SBIW13RVX	19	54	10	AISI 303	
G1/4	25SBIW13EVX	9286X25 13	19	54	10	AISI 316L
G3/8	25SBIW17RVX	19	53	9	AISI 303	
G3/8	25SBIW17EVX	9286X25 17	19	53	9	AISI 316L
G1/2	25SBIW21RVX	24	56	12	AISI 303	
G1/2	25SBIW21EVX	24	56	12	AISI 316L	



1/2" Universal industrial coupling with standard European profile for use with large pneumatic consumers. Coupling system with single-hand operation. High Flow valve for optimum flow and low pressure drop. The series stands out for its robust design, extremely high flow and long service life even with the harshest use. The collar design minimises damage to the valve body.

- Available on request:
 - with additional end connections
 - other seals for different temperature ranges and fluids

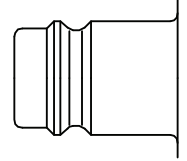

Euro Profile

Dust Protections (P. 357)
for Coupling Part.-No. SK27S

KA Single Shut-Off

Working Pressure*:
up to 35 bar

Material:

- Coupling: AISI 303 / AISI 316 L
- Plug: AISI 303 / AISI 316 L
- Seals: FKM

Working Temperature:
-15°C up to +200°C (FKM)

Flow Rate Air:
2.400 l/min.
inlet pressure 6 bar, pressure drop 0.5 bar

Flow Rate Water:
31 l/min.
pressure drop 0.5 bar

KB Double Shut-Off

Working Pressure*:
up to 35 bar

Material:

- Coupling: AISI 303 / AISI 316 L
- Plug: AISI 303 / AISI 316 L
- Seals: FKM

Working Temperature:
-15°C up to +200°C (FKM)

Flow Rate Air:
950 l/min.
inlet pressure 6 bar, pressure drop 0.5 bar

Flow Rate Water:
14 l/min.
pressure drop 0.5 bar

* maximum static working pressure with design factor 4 to 1.

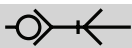

Single Shut-Off

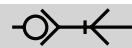

Single Shut-Off

27KAAW Coupler with valve, Male Thread

Stainless Steel, FKM

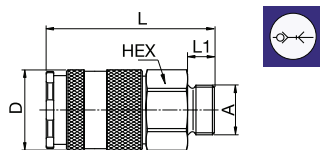

A	Version	HEX	L	L1	D	Version
G3/8	27KAAW17RVX	24	58	9	27	AISI 303
G3/8	27KAAW17EVX	24	58	9	27	AISI 316L
G1/2	27KAAW21RVX	24	60	12	27	AISI 303
G1/2	27KAAW21EVX	24	60	12	27	AISI 316L
G3/4	27KAAW26RVX	32	61	16	27	AISI 303
G3/4	27KAAW26EVX	32	61	16	27	AISI 316L

27KAIW Coupler with valve, Female Thread

Stainless Steel, FKM

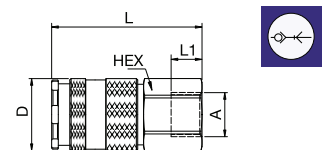

A	Version	HEX	L	L1	D	Version
G3/8	27KAIW17RVX	24	56	11	27	AISI 303
G3/8	27KAIW17EVX	24	56	11	27	AISI 316L
G1/2	27KAIW21RVX	24	56	12	27	AISI 303
G1/2	27KAIW21EVX	24	56	12	27	AISI 316L
G3/4	27KAIW26RVX	32	60	16	27	AISI 303
G3/4	27KAIW26EVX	32	60	16	27	AISI 316L

Series 27 - Stainless Steel

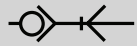

Single Shut-Off

27KATF Coupler with valve, Hose Barb

Stainless Steel, FKM

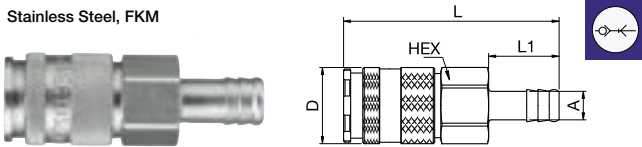

A	HEX	L	L1	D	Version	
9	27KATF09RVX	24	76	25	27	AISI 303
9	27KATF09EVX	24	76	25	27	AISI 316L
13	27KATF13RVX	24	76	25	27	AISI 303
13	27KATF13EVX	24	76	25	27	AISI 316L

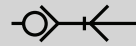

Single Shut-Off

27SFTF Plug without valve, Hose Barb

Stainless Steel

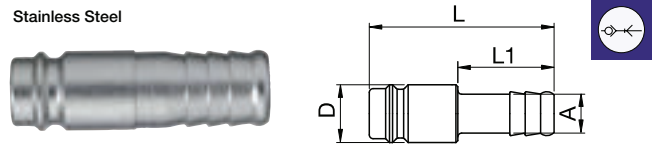

A	L	L1	D	Version	
9	27SFTF09RXX	48	25	15	AISI 303
9	27SFTF09EXX	48	25	15	AISI 316L
13	27SFTF13RXX	48	25	15	AISI 303
13	27SFTF13EXX	48	25	15	AISI 316L

27SFAW Plug without valve, Male Thread

Stainless Steel

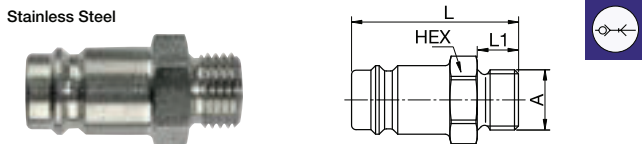

A	HEX	L	L1	Version		
G1/4	27SFAW13RXX	17	36.5	9	AISI 303	
G1/4	27SFAW13EXX	17	36.5	9	AISI 316L	
G3/8	27SFAW17RXX	19	36.5	9	AISI 303	
G3/8	27SFAW17EXX	19	36.5	9	AISI 316L	
G1/2	27SFAW21RXX	24	40	12	AISI 303	
G1/2	27SFAW21EXX	9087X27 21	24	40	12	AISI 316L
G3/4	27SFAW26RXX	32	45	16	AISI 303	
G3/4	27SFAW26EXX	9087X27 27	32	45	16	AISI 316L

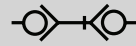

Double Shut-off

27KBAW Coupler with valve, Male Thread

Stainless Steel, FKM

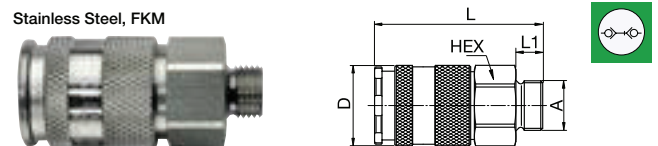

A	HEX	L	L1	D	Version		
G3/8	27KBAW17RVX	24	58	9	27	AISI 303	
G3/8	27KBAW17EVX	9201X27 17	24	58	9	27	AISI 316L
G1/2	27KBAW21RVX	24	60	12	27	AISI 303	
G1/2	27KBAW21EVX	9201X27 21	24	60	12	27	AISI 316L
G3/4	27KBAW26RVX	32	61	16	27	AISI 303	
G3/4	27KBAW26EVX	9201X27 27	32	61	16	27	AISI 316L

27SFIW Plug without valve, Female Thread

Stainless Steel

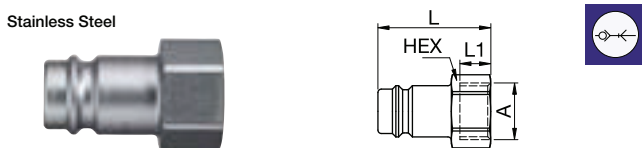

A	HEX	L	L1	Version		
G3/8	27SFIW17RXX	19	33	9	AISI 303	
G3/8	27SFIW17EXX	9086X27 17	19	33	9	AISI 316L
G1/2	27SFIW21RXX	24	37	12	AISI 303	
G1/2	27SFIW21EXX	24	37	12	AISI 316L	
G3/4	27SFIW26RXX	32	42	16	AISI 303	
G3/4	27SFIW26EXX	32	42	16	AISI 316L	

27KBIW Coupler with valve, Female Thread

Stainless Steel, FKM

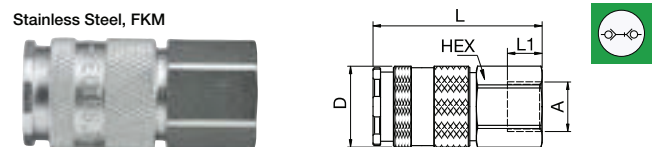

A	HEX	L	L1	D	Version		
G3/8	27KBIW17RVX	24	56	11	27	AISI 303	
G3/8	27KBIW17EVX	9214X27 17	24	56	11	27	AISI 316L
G1/2	27KBIW21RVX	24	56	12	27	AISI 303	
G1/2	27KBIW21EVX	9214X27 21	24	56	12	27	AISI 316L
G3/4	27KBIW26RVX	32	56	16	27	AISI 303	
G3/4	27KBIW26EVX	9214X27 27	32	56	16	27	AISI 316L

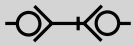

Double Shut-off

27KBTF Coupler with valve, Hose Barb

Stainless Steel, FKM

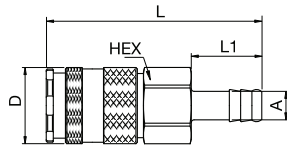

A	HEX	L	L1	D	Version
9	27KBTFO9RVX	24	76	25	AISI 303
9	27KBTFO9EVX	24	76	25	AISI 316L
13	27KBTF13RVX	24	76	25	AISI 303
13	27KBTF13EVX	24	76	25	AISI 316L

27SBAW Plug with valve, Male Thread

Stainless Steel, FKM

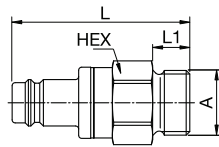

A	HEX	L	L1	Version
G3/8	27SBAW17RVX	24	56	AISI 303
G3/8	27SBAW17EVX	9287X27 17	24	AISI 316L
G1/2	27SBAW21RVX	24	58	AISI 303
G1/2	27SBAW21EVX	9287X27 21	24	AISI 316L
G3/4	27SBAW26RVX	32	58	AISI 303
G3/4	27SBAW26EVX	9287X27 27	32	AISI 316L

27SBIW Plug with valve, Female Thread

Stainless Steel, FKM

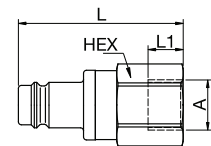

A	HEX	L	L1	Version
G3/8	27SBIW17RVX	24	55	AISI 303
G3/8	27SBIW17EVX	9286X27 17	24	AISI 316L
G1/2	27SBIW21RVX	24	55	AISI 303
G1/2	27SBIW21EVX	9286X27 21	24	AISI 316L
G3/4	27SBIW26RVX	32	58	AISI 303
G3/4	27SBIW26EVX	32	58	AISI 316L

27SBTF Plug with valve, Hose Barb

Stainless Steel, FKM

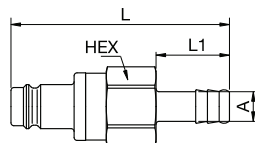

A	HEX	L	L1	Version
9	27SBTF09RVX	24	75	AISI 303
9	27SBTF09EVX	24	75	AISI 316L
13	27SBTF13RVX	24	75	AISI 303
13	27SBTF13EVX	24	75	AISI 316L



Coupling series in sizes 1/8" to 1" with plug profile compliant with ISO 7241-1 series B. Particularly suited to use with liquid media. Coupling system with two-hand operation, i.e. both hands are required when coupling/uncoupling. The coupling series stands out for its high flow rates against a low pressure drop.

- Available on request:
 - other seals for different temperature ranges and fluids

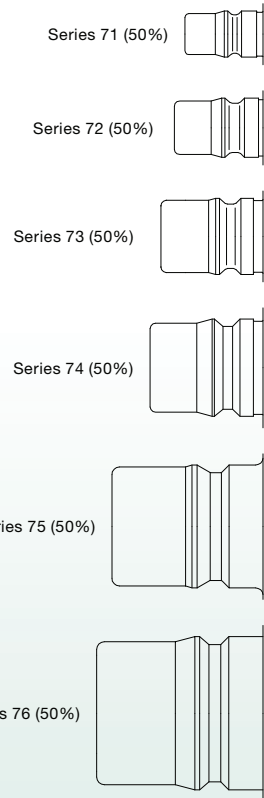

ISO 7241-1 B Profile



Working Pressure*:
see table

Material:

- Coupling: AISI 303 / AISI 316 L
- Plug: AISI 303 / AISI 316 L
- Seals: FKM

Working Temperature:

-15°C up to +200°C (FKM)

Flow Rate Water:

- Series 71: 6 l/min.
- Series 72: 9 l/min.
- Series 73: 17 l/min.
- Series 74: 33 l/min.
- Series 75: 79 l/min.
- Series 76: 117 l/min.

pressure drop 0.5 bar

* maximum static working pressure with design factor 4 to 1.

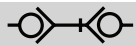

Double Shut-off



Double Shut-off

70KBIW Coupler with valve, Female Thread

Stainless Steel, FKM

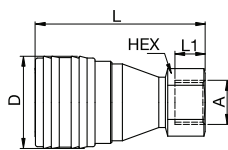

Size	A	Part No.	HEX	L	L1	D	Version	max. Working Pressure
1/8"	G1/8	71KBIW10RVX	14	48.5	7	25	AISI 303	250
1/4"	G1/4	72KBIW13RVX	19	57.5	10	29	AISI 303	250
1/4"	G1/4	72KBIW13EVX	19	57.5	10	29	AISI 316L	250
3/8"	G3/8	73KBIW17RVX	22	64	11.5	35	AISI 303	250
3/8"	G3/8	73KBIW17EVX	22	64	11.5	35	AISI 316L	250
1/2"	G1/2	74KBIW21RVX	27	76	16	44.5	AISI 303	250
1/2"	G1/2	74KBIW21EVX	27	76	16	44.5	AISI 316L	250
3/4"	G3/4	75KBIW26RVX	34	96	24	55	AISI 303	160
3/4"	G3/4	75KBIW26EVX	34	96	24	55	AISI 316L	160
1"	G1	76KBIW33RVX	41	105.5	24	62	AISI 303	100
1"	G1	76KBIW33EVX	41	105.5	24	62	AISI 316L	100

70SBIW Plug with valve, Female Thread

Stainless Steel, FKM

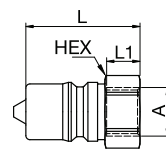

Size	A	Part No.	HEX	L	L1	Version	max. Working Pressure
1/8"	G1/8	71SBIW10RVX	14	29.5	7	AISI 303	250
1/4"	G1/4	72SBIW13RVX	19	35	10	AISI 303	250
1/4"	G1/4	72SBIW13EVX	19	35	10	AISI 316L	250
3/8"	G3/8	73SBIW17RVX	22	39	11.5	AISI 303	250
3/8"	G3/8	73SBIW17EVX	22	39	11.5	AISI 316L	250
1/2"	G1/2	74SBIW21RVX	27	48	16	AISI 303	250
1/2"	G1/2	74SBIW21EVX	27	48	16	AISI 316L	250
3/4"	G3/4	75SBIW26RVX	36	60	24	AISI 303	160
3/4"	G3/4	75SBIW26EVX	36	60	24	AISI 316L	160
1"	G1	76SBIW33RVX	41	65	24	AISI 303	100
1"	G1	76SBIW33EVX	41	65	24	AISI 316L	100



Mini industrial coupling in plastics POM and PVDF with the world's most popular profile in this nominal diameter. Above average flow performance for liquid and gaseous media. Coupling system with single-hand operation. This new type of plastic locking system with handy sleeve considerably expands the applications of this series. Two sleeve forms - tapered and cylindrical, where the tapered sleeve form facilitates handling with gloves. The color coding of the coupling and plug offers a guarantee for avoiding mix-ups between media when coupling.

- Available valve types:
 - Single Shut-off
 - Double Shut-off

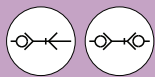

RectuPOM

Working Pressure*:

up to 10 bar (POM, at 20°C)

Material:

- Coupling: POM black
- Plug: POM black
- Seals: NBR

Working Temperature:

-20°C up to +80°C (POM)

Flow Rate Air:

- Single Shut-Off: 550 l/min.
- Double Shut-Off: 310 l/min.

inlet pressure 6 bar, pressure drop 0.5 bar

Flow Rate Water:

- Single Shut-Off: 7 l/min.
- Double Shut-Off: 2.7 l/min.

pressure drop 0.5 bar

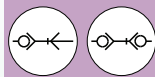

RectuChem

Working Pressure*:

up to 8 bar (PVDF, at 20°C)

Material:

- Coupling: PVDF white
- Plug: PVDF white
- Seals: FKM

Working Temperature:

-20°C up to +120°C (PVDF)

Flow Rate Air:

- Single Shut-Off: 550 l/min.
- Double Shut-Off: 310 l/min.

inlet pressure 6 bar, pressure drop 0.5 bar

Flow Rate Water:

- Single Shut-Off: 7 l/min.
- Double Shut-Off: 2.7 l/min.

pressure drop 0.5 bar

* maximum static working pressure with design factor 4 to 1.

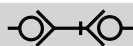
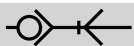

Single Shut-Off / Double Shut-off

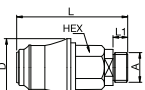
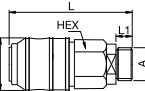

	Connection A	HEX	HEX1	L	L1	L2	D	B	G	Color Sleeve	Part Number POM	Part Number CHEM
 21KBAW Coupler with valve, Male Thread with tapered sleeve	G1/8	17	50	7			25.5			Standard	21KBAW10DPX	21KBAW10FVX
	G1/4	17	50	7			25.5			Standard	21KBAW13DPX	21KBAW13FVX
 21KBAW Coupler with valve, Male Thread with cylindrical sleeve	G1/8	17	50	7			21			Blue	21KBAW10DPXGB	21KBAW10FVXGB
	G1/8	17	50	7			21			Red	21KBAW10DPXGR	21KBAW10FVXGR
	G1/8	17	50	7			21			Standard	21KBAW10DPXG	21KBAW10FVXG
	G1/4	17	50	7			21			Blue	21KBAW13DPXGB	21KBAW13FVXGB
	G1/4	17	50	7			21			Red	21KBAW13DPXGR	21KBAW13FVXGR
	G1/4	17	50	7			21			Standard	21KBAW13DPXG	21KBAW13FVXG

Series 21 - Thermoplastic

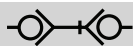
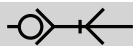

Single Shut-Off / Double Shut-off

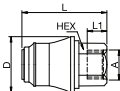
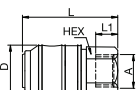
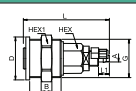
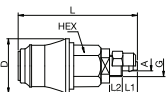

	Connection A	HEX	HEX1	L	L1	L2	D	B	G	Color Sleeve	Part Number POM	Part Number CHEM	
 21KBIW Coupler with valve, Female Thread with tapered sleeve	G1/8	17		53	8		25.5			Standard	21KBIW10DPX	21KBIW10FVX	
	G1/4	17		39	9		25.5			Standard	21KBIW13DPX	21KBIW13FVX	
 21KBIW Coupler with valve, Female Thread with cylindrical sleeve	G1/8	17		53	8		21			Blue	21KBIW10DPXGB	21KBIW10FVXGB	
	G1/8	17		53	8		21			Red	21KBIW10DPXGR	21KBIW10FVXGR	
	G1/8	17		53	8		21			Standard	21KBIW10DPXG	21KBIW10FVXG	
	G1/4	17		39	9		21			Blue	21KBIW13DPXGB	21KBIW13FVXGB	
	G1/4	17		39	9		21			Red	21KBIW13DPXGR	21KBIW13FVXGR	
	G1/4	17		39	9		21			Standard	21KBIW13DPXG	21KBIW13FVXG	
	 21KBKE Coupler with valve, Panel Mount for Plastic Hose Connection for Front Panel Installation	4 x 6	17	27	56	7	20.5	28	7	M25x1	Standard	21KBKE06DPX	21KBKE06FVX
		6 x 8	17	27	56	7	20.5	28	7	M25x1	Standard	21KBKE08DPX	21KBKE08FVX
		 21KBKO Coupler with valve, with Plastic Hose Connection with tapered sleeve	4 x 6	17		56	6	7	25.5		M10x1	Standard	21KBK006DPX
	6 x 8		17		56	6	7	25.5		M12x1	Standard	21KBK008DPX	21KBK008FVX
4 x 6	17			56	6	7	21			Blue	21KBK006DPXGB	21KBK006FVXGB	
4 x 6	17			56	6	7	21			Red	21KBK006DPXGR	21KBK006FVXGR	
4 x 6	17			56	6	7	21			Standard	21KBK006DPXG	21KBK006FVXG	
6 x 8	17			56	6	7	21			Blue	21KBK008DPXGB	21KBK008FVXGB	
6 x 8	17			56	6	7	21			Red	21KBK008DPXGR	21KBK008FVXGR	
6 x 8	17		56	6	7	21			Standard	21KBK008DPXG	21KBK008FVXR		

Series 21 - Thermoplastic

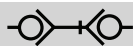
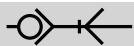

Single Shut-Off / Double Shut-off

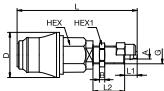
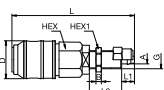
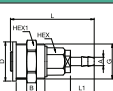
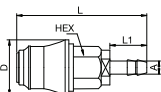
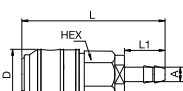

	Connection A	HEX	HEX1	L	L1	L2	D	B	G	Color Sleeve	Part Number POM	Part Number CHEM
 <p>21KBKS Coupler with valve, Panel Mount with Plastic Hose Connection with tapered sleeve</p>	4 x 6	17	14	68	7	18	25.5	4	M10x1	Standard	21KBKS06DPX	21KBKS06FVX
	6 x 8	17	17	68	7	18	25.5	4	M12x1	Standard	21KBKS08DPX	21KBKS08FVX
 <p>21KBKS Coupler with valve, Panel Mount with Plastic Hose Connection with cylindrical sleeve</p>	4 x 6	17	14	68	7	18	21	4	M10x1	Blue	21KBKS06DPXGB	21KBKS06FVXGB
	4 x 6	17	14	68	7	18	21	4	M10x1	Red	21KBKS06DPXGR	21KBKS06FVXGR
	4 x 6	17	14	68	7	18	21	4	M10x1	Standard	21KBKS06DPXG	21KBKS06FVXG
	6 x 8	17	17	68	7	18	21	4	M12x1	Blue	21KBKS08DPXGB	21KBKS08FVXGB
	6 x 8	17	17	68	7	18	21	4	M12x1	Red	21KBKS08DPXGR	21KBKS08FVXGR
	6 x 8	17	17	68	7	18	21	4	M12x1	Standard	21KBKS08DPXG	21KBKS08FVXG
 <p>21KBTE Coupler with valve, Panel Mount for Hose Barb for Front Panel Installation</p>	4	17	27	60	17	20.5	28	7	M25x1	Standard	21KBTE04DPX	21KBTE04FVX
	6	17	27	60	17	20.5	28	7	M25x1	Standard	21KBTE06DPX	21KBTE06FVX
 <p>21KBTF Coupler with valve, Hose Barb with tapered sleeve</p>	4	17		60	17		25.5			Standard	21KBTF04DPX	21KBTF04FVX
	6	17		60	17		25.5			Standard	21KBTF06DPX	21KBTF06FVX
	4	17		60	17		21			Blue	21KBTF04DPXGB	21KBTF04FVXGB
	4	17		60	17		21			Red	21KBTF04DPXGR	21KBTF04FVXGR
 <p>21KBTF Coupler with valve, Hose Barb with cylindrical sleeve</p>	4	17		60	17		21			Standard	21KBTF04DPXG	21KBTF04FVXG
	6	17		60	17		21			Blue	21KBTF06DPXGB	21KBTF06FVXGB
	6	17		60	17		21			Red	21KBTF06DPXGR	21KBTF06FVXGR
	6	17		60	17		21			Standard	21KBTF06DPXG	21KBTF06FVXG

Series 21 - Thermoplastic

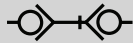
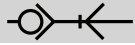

Single Shut-Off / Double Shut-off



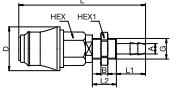
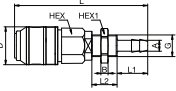

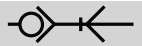
	Connection A	HEX	HEX1	L	L1	L2	D	B	G	Color Sleeve	Part Number POM	Part Number CHEM
 <p>21KBT5 Coupler with valve, Panel Mount with Hose Barb with tapered sleeve</p>	4	17	14	74	17	14	25.5	4	M10x1	Standard	21KBT504DPX	21KBT504FVX
	6	17	14	74	17	14	25.5	4	M10x1	Standard	21KBT506DPX	21KBT506FVX
	4	17	14	74	17	14	21	4	M10x1	Blue	21KBT504DPXGB	21KBT504FVXGB
 <p>21KBT6 Coupler with valve, Panel Mount with Hose Barb with cylindrical sleeve</p>	4	17	14	74	17	14	21	4	M10x1	Red	21KBT504DPXGR	21KBT504FVXGR
	4	17	14	74	17	14	21	4	M10x1	Standard	21KBT504DPXG	21KBT504FVXG
	6	17	17	74	17	14	21	4	M12x1	Blue	21KBT506DPXGB	21KBT506FVXGB
	6	17	17	74	17	14	21	4	M12x1	Red	21KBT506DPXGR	21KBT506FVXGR
	6	17	17	74	17	14	21	4	M12x1	Standard	21KBT506DPXG	21KBT506FVXG



Single Shut-Off

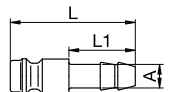

	Connection A	HEX	HEX1	L	L1	L2	D	B	G	Color Sleeve	Part Number POM	Part Number CHEM
 <p>21SFAW Plug without valve, Male Thread</p>	G1/4	17		28	9					Standard	21SFAW13DXX	21SFAW13FXX
	G1/4	17		25	9					Blue	21SFIW13DXXB	21SFIW13FXXB
 <p>21SFIW Plug without valve, Female Thread</p>	G1/4	17		25	9				Red	21SFIW13DXXR	21SFIW13FXXR	
	G1/4	17		25	9					Standard	21SFIW13DXX	21SFIW13FXX
	 <p>21SFTF Plug without valve, Hose Barb</p>	4			32	17				Standard	21SFTF04DXX	21SFTF04FXX
6				32	17					Standard	21SFTF06DXX	21SFTF06FXX

Series 21 - Thermoplastic

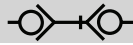
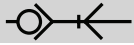

Single Shut-Off / Double Shut-off

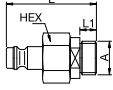
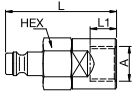
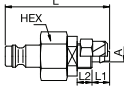

Connection A	HEX	HEX1	L	L1	L2	D	B	G	Color Sleeve	Part Number POM	Part Number CHEM
 21SBAW Plug with valve, Male Thread	G1/8	17	36	7					Blue	21SBAW10DPXB	21SBAW10FVXB
	G1/8	17	36	7					Red	21SBAW10DPXR	21SBAW10FVXR
	G1/8	17	36	7					Standard	21SBAW10DPX	21SBAW10FVX
	G1/4	17	38	7					Blue	21SBAW13DPXB	21SBAW13FVXB
	G1/4	17	38	7					Red	21SBAW13DPXR	21SBAW13FVXR
	G1/4	17	38	7					Standard	21SBAW13DPX	21SBAW13FVX
	G1/8	17	39	8					Blue	21SBIW10DPXB	21SBIW10FVXB
	G1/8	17	39	8					Red	21SBIW10DPXR	21SBIW10FVXR
	G1/8	17	39	8					Standard	21SBIW10DPX	21SBIW10FVX
 21SBIW Plug with valve, Female Thread	G1/4	17	42	10					Blue	21SBIW13DPXB	21SBIW13FVXB
	G1/4	17	42	10					Red	21SBIW13DPXR	21SBIW13FVXR
	G1/4	17	42	10					Standard	21SBIW13DPX	21SBIW13FVX
	4 x 6	17	42	7	6				Blue	21SBK006DPXB	21SBK006FVXB
	4 x 6	17	42	7	6				Red	21SBK006DPXR	21SBK006FVXR
	4 x 6	17	42	7	6				Standard	21SBK006DPX	21SBK006FVX
 21SBK0 Plug with valve, with Plastic Hose Connection	6 x 8	17	42	7	6				Blue	21SBK008DPXB	21SBK008FVXB
	6 x 8	17	42	7	6				Red	21SBK008DPXR	21SBK008FVXR
	6 x 8	17	42	7	6				Standard	21SBK008DPX	21SBK008FVX

Series 21 - Thermoplastic

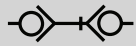

Double Shut-Off

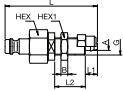
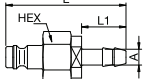
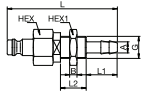

	Connection A	HEX	HEX1	L	L1	L2	D	B	G	Color Sleeve	Part Number POM	Part Number CHEM
	4 x 6	17	14	54	7	18	4		M10x1	Blue	21SBKS06DPXB	21SBKS06FVXB
	4 x 6	17	14	54	7	18	4		M10x1	Red	21SBKS06DPXR	21SBKS06FVXR
	4 x 6	17	14	54	7	18	4		M10x1	Standard	21SBKS06DPX	21SBKS06FVX
 <p>21SBKS Plug with valve, Panel Mount with Plastic Hose Connection</p>	6 x 8	17	17	54	7	18	4		M12x1	Blue	21SBKS08DPXB	21SBKS08FVXB
	6 x 8	17	17	54	7	18	4		M12x1	Red	21SBKS08DPXR	21SBKS08FVXR
	6 x 8	17	17	54	7	18	4		M12x1	Standard	21SBKS08DPX	21SBKS08FVX
	4	17		46	17					Standard	21SBTF04DPX	21SBTF04FVX
	4	17		46	17					Blue	21SBTF04DPXB	21SBTF04FVXB
	4	17		46	17					Red	21SBTF04DPXR	21SBTF04FVXR
 <p>21SBTF Plug with valve, Hose Barb</p>	6	17		46	17					Standard	21SBTF06DPX	21SBTF06FVX
	6	17		46	17					Blue	21SBTF06DPXB	21SBTF06FVXB
	6	17		46	17					Red	21SBTF06DPXR	21SBTF06FVXR
	4	17	14	60	7	14	4		M10x1	Blue	21SBTS04DPXB	21SBTS04FVXB
	4	17	14	60	7	14	4		M10x1	Red	21SBTS04DPXR	21SBTS04FVXR
	4	17	14	60	7	14	4		M10x1	Standard	21SBTS04DPX	21SBTS04FVX
 <p>21SBTS Plug with valve, Panel Mount with Hose Barb</p>	6	17	17	60	7	14	4		M12x1	Blue	21SBTS06DPXB	21SBTS06FVXB
	6	17	17	60	7	14	4		M12x1	Red	21SBTS06DPXR	21SBTS06FVXR
	6	17	17	60	7	14	4		M12x1	Standard	21SBTS06DPX	21SBTS06FVX



Coupling series made of POM and PVDF has been developed for use in the medical, chemical, food handling, pharmaceutical and laboratory technology industries. The system is also available in a solid plastic design (RectuChem+). Here the metal springs are replaced by springs made of PEEK, an extremely resistant synthetic material. Coupling system with single-hand operation. The color coding of the coupling and plug offers a guarantee for avoiding mix-ups between media when coupling. The coupling is also available with no valve for a straight-through system.

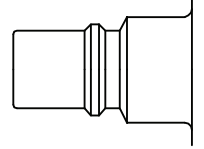

- Available valve types:
 - Single Shut-off
 - Double Shut-off

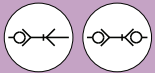

RectuPOM

Working Pressure*:
up to 10 bar (POM, at 20°C)

Material:

- Coupling: POM black
- Plug: POM black
- Seals: NBR

Working Temperature:
-20°C up to +80°C (POM)

Flow Rate Air:

- Single Shut-Off: 1.100 l/min.
 - Double Shut-Off: 770 l/min.
- inlet pressure 6 bar, pressure drop 0.5 bar

Flow Rate Water:

- Single Shut-Off: 17 l/min.
 - Double Shut-Off: 12 l/min.
- pressure drop 0.5 bar

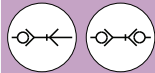

RectuChem

Working Pressure*:
up to 8 bar (PVDF, with metal springs)

Material:

- Coupling: PVDF white
- Plug: PVDF white
- Seals: FKM

Working Temperature:
-20°C up to +120°C (PVDF)

Flow Rate Air:

- Single Shut-Off: 1.100 l/min.
 - Double Shut-Off: 770 l/min.
- inlet pressure 6 bar, pressure drop 0.5 bar

Flow Rate Water:

- Single Shut-Off: 17 l/min.
 - Double Shut-Off: 12 l/min.
- pressure drop 0.5 bar

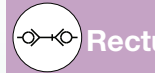

RectuChem+

Working Pressure*:
1-8 bar (PVDF, with PEEK-spring)

Material:

- Coupling: PVDF white, PEEK-spring
- Plug: PVDF white, PEEK-spring
- Seals: FKM

Working Temperature:
-20°C up to +120°C (PVDF)

Flow Rate Air:

- Double Shut-Off: 770 l/min.
- inlet pressure 6 bar, pressure drop 0.5 bar

Flow Rate Water:

- Double Shut-Off: 12 l/min.
- pressure drop 0.5 bar

* maximum static working pressure with design factor 4 to 1.

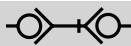
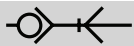

Single Shut-Off / Double Shut-off



Connection A	HEX	L	L1	D	Color Sleeve	Part Number POM	Part Number CHEM	Part Number CHEM+
G1/4	21	70.5	9	26	Standard	48KBAW13DPX	48KBAW13FVX	48KBAW13FVP
G1/4	21	70.5	9	26	Red	48KBAW13DPXR	48KBAW13FVXR	48KBAW13FVPR
G1/4	21	70.5	9	26	Blue	48KBAW13DPXB	48KBAW13FVXB	48KBAW13FVPB
G3/8	21	67	9	26	Standard	48KBAW17DPX	48KBAW17FVX	48KBAW17FVP
G3/8	21	67	9	26	Red	48KBAW17DPXR	48KBAW17FVXR	48KBAW17FVPR
G3/8	21	67	9	26	Blue	48KBAW17DPXB	48KBAW17FVXB	48KBAW17FVPB
G1/2	21	73.5	12	26	Standard	48KBAW21DPX	48KBAW21FVX	48KBAW21FVP
G1/2	21	73.5	12	26	Red	48KBAW21DPXR	48KBAW21FVXR	48KBAW21FVPR
G1/2	21	73.5	12	26	Blue	48KBAW21DPXB	48KBAW21FVXB	48KBAW21FVPB

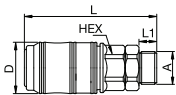

48KBAW

Coupler with valve, Male Thread

Series 48 - Thermoplastic

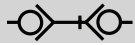
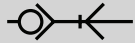

Single Shut-Off / Double Shut-off



Connection A	HEX	L	L1	D	Color Sleeve	Part Number POM	Part Number CHEM	Part Number CHEM+
G1/4	21	63.5	10	26	Standard	48KBIW13DPX	48KBIW13FVX	48KBIW13FVP
G1/4	21	63.5	10	26	Red	48KBIW13DPXR	48KBIW13FVXR	48KBIW13FVPR
G1/4	21	63.5	10	26	Blue	48KBIW13DPXB	48KBIW13FVXB	48KBIW13FVPB
G3/8	21	63.5	13	26	Standard	48KBIW17DPX	48KBIW17FVX	48KBIW17FVP
G3/8	21	63.5	13	26	Red	48KBIW17DPXR	48KBIW17FVXR	48KBIW17FVPR
G3/8	21	63.5	13	26	Blue	48KBIW17DPXB	48KBIW17FVXB	48KBIW17FVPB
G1/2	21	74.5	13	26	Standard	48KBIW21DPX	48KBIW21FVX	48KBIW21FVP
G1/2	21	74.5	13	26	Red	48KBIW21DPXR	48KBIW21FVXR	48KBIW21FVPR
G1/2	21	74.5	13	26	Blue	48KBIW21DPXB	48KBIW21FVXB	48KBIW21FVPB
6	21	81	22	26	Standard	48KBTf06DPX	48KBTf06FVX	48KBTf06FVP
6	21	81	22	26	Red	48KBTf06DPXR	48KBTf06FVXR	48KBTf06FVPR
6	21	81	22	26	Blue	48KBTf06DPXB	48KBTf06FVXB	48KBTf06FVPB
9	21	81	22	26	Standard	48KBTf09DPX	48KBTf09FVX	48KBTf09FVP
9	21	81	22	26	Red	48KBTf09DPXR	48KBTf09FVXR	48KBTf09FVPR
9	21	81	22	26	Blue	48KBTf09DPXB	48KBTf09FVXB	48KBTf09FVPB
13	21	84	25	26	Standard	48KBTf13DPX	48KBTf13FVX	48KBTf13FVP
13	21	84	25	26	Red	48KBTf13DPXR	48KBTf13FVXR	48KBTf13FVPR
13	21	84	25	26	Blue	48KBTf13DPXB	48KBTf13FVXB	48KBTf13FVPB

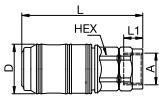

48KBIW
Coupler with valve, Female Thread

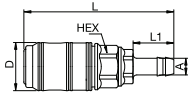

48KBTf
Coupler with valve, Hose Barb

Series 48 - Thermoplastic

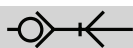

Single Shut-Off

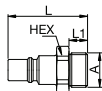
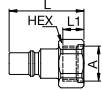
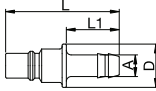

	Connection A	HEX	L	L1	D	Color Sleeve	Part Number POM	Part Number CHEM	Part Number CHEM+
 <p>48SFAW Plug without valve, Male Thread</p>	G3/8	21	38.5	9		Standard	48SFAW17DXX	48SFAW17FXX	
	G3/8	21	35.5	10		Standard	48SFIW17DXX	48SFIW17FXX	
 <p>48SFIW Plug without valve, Female Thread</p>	G3/8	21	35.5	10		Red	48SFIW17DXXR	48SFIW17FXXR	
	G3/8	21	35.5	10		Blue	48SFIW17DXXB	48SFIW17FXXB	
	G3/8	21	35.5	10		Standard	48SFTF09DXX	48SFTF09FXX	
 <p>48SFTF Plug without valve, Hose Barb</p>	9		47	22	18	Standard	48SFTF09DXX	48SFTF09FXX	

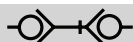

Double Shut-off

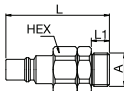

	Connection A	HEX	L	L1	D	Color Sleeve	Part Number POM	Part Number CHEM	Part Number CHEM+
 <p>48SBAW Plug with valve, Male Thread</p>	G1/4	21	55	9		Standard	48SBAW13DPX	48SBAW13FVX	48SBAW13DPX
	G1/4	21	55	9		Red	48SBAW13DPXR	48SBAW13FVXR	48SBAW13DPX
	G1/4	21	55	9		Blue	48SBAW13DPXB	48SBAW13FVXB	48SBAW13DPX
	G3/8	21	51.5	9		Standard	48SBAW17DPX	48SBAW17FVX	48SBAW17FVP
	G3/8	21	51.5	9		Red	48SBAW17DPXR	48SBAW17FVXR	48SBAW17FVPR
	G3/8	21	51.5	9		Blue	48SBAW17DPXB	48SBAW17FVXB	48SBAW17FVPB
	G1/2	21	58	12		Standard	48SBAW21DPX	48SBAW21FVX	48SBAW21FVP
	G1/2	21	58	12		Red	48SBAW21DPXR	48SBAW21FVXR	48SBAW21FVPR
	G1/2	21	58	12		Blue	48SBAW21DPXB	48SBAW21FVXB	48SBAW21FVPB

Series 48 - Thermoplastic

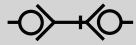

Double Shut-off



Connection A	HEX	L	L1	D	Color Sleeve	Part Number POM	Part Number CHEM	Part Number CHEM+
G1/4	21	48	10		Standard	48SBIW13DPX	48SBIW13FVX	48SBIW13FVP
G1/4	21	48	10		Red	48SBIW13DPXR	48SBIW13FVXR	48SBIW13FVPR
G1/4	21	48	10		Blue	48SBIW13DPXB	48SBIW13FVXB	48SBIW13FVPB
G3/8	21	48	10		Standard	48SBIW17DPX	48SBIW17FVX	48SBIW17FVP
G3/8	21	48	10		Red	48SBIW17DPXR	48SBIW17FVXR	48SBIW17FVPR
G3/8	21	48	10		Blue	48SBIW17DPXB	48SBIW17FVXB	48SBIW17FVPB
G1/2	21	59	13		Standard	48SBIW21DPX	48SBIW21FVX	48SBIW21FVP
G1/2	21	59	13		Red	48SBIW21DPXR	48SBIW21FVXR	48SBIW21FVPR
G1/2	21	59	13		Blue	48SBIW21DPXB	48SBIW21FVXB	48SBIW21FVPB
6	21	65.5	22		Standard	48SBTF06DPX	48SBTF06FVX	48SBTF06FVP
6	21	65.5	22		Red	48SBTF06DPXR	48SBTF06FVXR	48SBTF06FVPR
6	21	65.5	22		Blue	48SBTF06DPXB	48SBTF06FVXB	48SBTF06FVPB
9	21	65.5	22		Standard	48SBTF09DPX	48SBTF09FVX	48SBTF09FVP
9	21	65.5	22		Red	48SBTF09DPXR	48SBTF09FVXR	48SBTF09FVPR
9	21	65.5	22		Blue	48SBTF09DPXB	48SBTF09FVXB	48SBTF09FVPB
13	21	68.5	25		Standard	48SBTF13DPX	48SBTF13FVX	48SBTF13FVP
13	21	68.5	25		Red	48SBTF13DPXR	48SBTF13FVXR	48SBTF13FVPR
13	21	68.5	25		Blue	48SBTF13DPXB	48SBTF13FVXB	48SBTF13FVPB

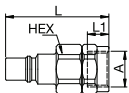

48SBIW
Plug with valve, Female Thread

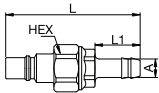

48SBTF
Plug with valve, Hose Barb



Coupling range in sizes from 1/4" to 1" with plug profile in accordance with ISO 7241-1 series B. Particularly suitable for use with liquid media. Coupling system with two-hand operation, i.e. the locking sleeve must be pushed back manually when coupling. The coupling range stands out for its high flow rates against a low pressure drop.

- Available valve type:
 - Double Shut-off

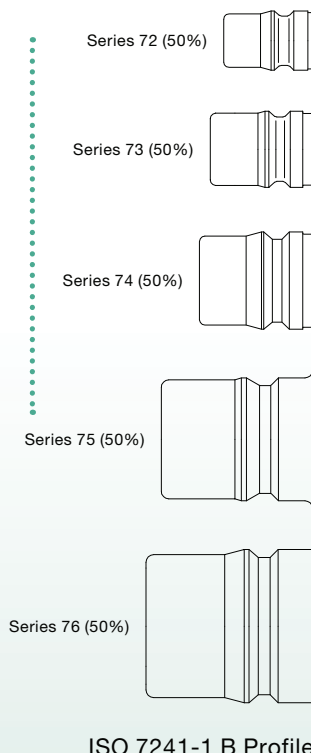

Working Pressure*:
see table

- Material:**
- Coupling: POM white
 - Plug: POM white
 - Seals: NBR

Working Temperature:
-20°C up to +90°C (NBR)

- Flow Rate Water:**
- Series 72: 9 l/min.
 - Series 73: 17 l/min.
 - Series 74: 33 l/min.
 - Series 75: 79 l/min.
 - Series 76: 117 l/min.
- pressure drop 0.5 bar

* maximum static working pressure with design factor 4 to 1.

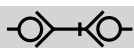

Double Shut-off

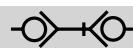

Double Shut-off

70KBIW Coupler with valve, Female Thread

POM, NBR

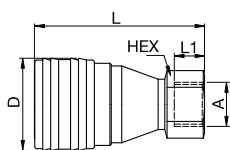

Size	A		HEX	L	L1	D	max. Working Pressure
1/8"	G1/8	71KBIW10DPX	14	48.5	7	25	15
1/4"	G1/4	72KBIW13DPX	19	57.5	10	29	15
3/8"	G3/8	73KBIW17DPX	22	64	11.5	35	15
1/2"	G1/2	74KBIW21DPX	27	76	16	44.5	10
3/4"	G3/4	75KBIW26DPX	34	96	24	55	10
1"	G1	76KBIW33DPX	41	105.5	24	62	10

70SBIW Plug with valve, Female Thread

POM, NBR

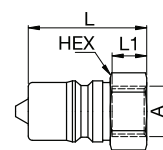

Size	A		HEX	L	L1	max. Working Pressure
1/8"	G1/8	71SBIW10DPX	14	29.5	7	15
1/4"	G1/4	72SBIW13DPX	19	35	10	15
3/8"	G3/8	73SBIW17DPX	22	39	11.5	15
1/2"	G1/2	74SBIW21DPX	27	48	16	10
3/4"	G3/4	75SBIW26DPX	36	60	24	10
1"	G1	76SBIW33DPX	41	56	24	10

DN Male x Male Nipple

POM or CHEM

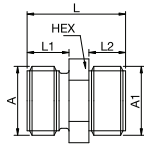

A	A1		HEX	L	L1	L2	Version
G1/4	G1/8	DN13/10DX	14	19	8	7	POM
G1/4	G1/4	DN13/13DX	14	19	8	7	POM
G3/8	G1/4	DN17/13DX	17	28.5	9	9	POM
G3/8	G3/8	DN17/17DX	21	25	9	9	POM
G3/8	G1/2	DN17/21DX	21	31.5	9	12	POM
G1/4	G1/8	DN13/10FX	14	19	8	7	CHEM
G1/4	G1/4	DN13/13FX	14	19	8	7	CHEM
G3/8	G1/4	DN17/13FX	17	28.5	9	9	CHEM
G3/8	G3/8	DN17/17FX	21	25	9	9	CHEM
G3/8	G1/2	DN17/21FX	21	31.5	9	12	CHEM

ET Panel Mount, Standard Hose Connection

POM or CHEM

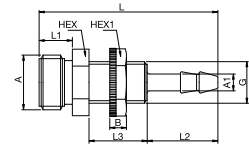

A		HEX	HEX1	B	G	L	L1	L2	Version
G1/4	ET13/04DX	14	14	4	M10x1	43	7	8	POM
G1/4	ET13/06DX	14	17	4	M12x1	43	8	8	POM
G1/4	ET13/04FX	14	14	4	M10x1	43	7	8	CHEM
G1/4	ET13/06FX	14	17	4	M12x1	43	8	8	CHEM

RL Reducing Bush

POM or CHEM

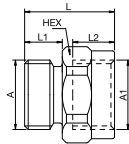

A	A1		HEX	L	L1	L2	Version
G1/4	G1/8	RL13/10DX	14	22	8	8	POM
G1/4	G1/4	RL13/13DX	17	25	8	10	POM
G3/8	G1/4	RL17/13DX	17	21.5	9	10	POM
G3/8	G3/8	RL17/17DX	21	21.5	9	10	POM
G3/8	G1/2	RL17/21DX	17	32.5	9	13	POM
G1/4	G1/8	RL13/10FX	14	22	8	8	CHEM
G1/4	G1/4	RL13/13FX	17	25	8	10	CHEM
G3/8	G1/4	RL17/13FX	17	21.5	9	10	CHEM
G3/8	G3/8	RL17/17FX	21	21.5	9	10	CHEM
G3/8	G1/2	RL17/21FX	17	32.5	9	13	CHEM

GT Hose Tail Barb

POM or CHEM

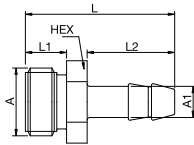

A	A1		HEX	L	L1	L2	Version
G1/4	4	GT13/04DX	14	29	8	17	POM
G1/4	6	GT13/06DX	14	29	8	17	POM
G3/8	6	GT17/06DX	17	39	9	22	POM
G3/8	9	GT17/09DX	17	39	9	22	POM
G3/8	13	GT17/13DX	17	42	9	25	POM
G1/4	4	GT13/04FX	14	29	8	17	CHEM
G1/4	6	GT13/06FX	14	29	8	17	CHEM
G3/8	6	GT17/06FX	17	39	9	22	CHEM
G3/8	9	GT17/09FX	17	39	9	22	CHEM
G3/8	13	GT17/13FX	17	42	9	25	CHEM



Dry-break coupling system for applications in sensitive environments, for example in analysis technology, in cooling systems, in transport systems and many applications with aggressive media. Coupling system with single-hand operation, extremely low leakage rates and minimal dead space volume. Absolutely no air pockets when coupling and only a barely noticeable film of the medium being channelled on the valve bodies when uncoupling. Ergonomic sleeve design. Low coupling forces. Valve body protected by collar design.

- Available on request:
 - other seals for different temperature ranges and fluids

Series 204 (50%)

Series 206 (50%)

Series 209 (50%)



Working Pressure*:
up to 15 bar

Material:

- Coupling: Nickel plated brass or AISI 316L
- Plug: Nickel plated brass or AISI316L
- Seals: NBR or FKM

Working Temperature:

- 20°C up to +100°C (NBR)
- 15°C bis +200°C (FKM)

Flow Rate Water:

- Series 204: 4.5 l/min.
 - Series 206: 8.9 l/min.
 - Series 209: 27 l/min.
- pressure drop 0.5 bar

* maximum static working pressure with design factor 4 to 1.



Dry-Break

200KLAW Coupler with valve, Male Thread

Nickel-plated brass or stainless steel, NBR or FKM

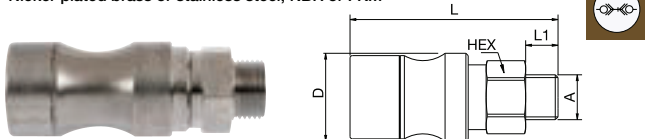

DN	A	Version	HEX	L	L1	D	Version
4	G1/8	204KLAW10MPN	14	45	7	19	Nickel-plated brass
4	G1/8	204KLAW10EVX	14	45	7	19	AISI 316L
4	G1/4	204KLAW13MPN	17	47	9	19	Nickel-plated brass
4	G1/4	204KLAW13EVX	17	47	9	19	AISI 316L
6	G3/8	206KLAW17MPN	22	69	9	25.5	Nickel-plated brass
6	G3/8	206KLAW17EVX	22	69	9	25.5	AISI 316L
6	G1/2	206KLAW21MPN	22	72	12	25.5	Nickel-plated brass
6	G1/2	206KLAW21EVX	24	72	12	25.5	AISI 316L



Dry-Break

200KLIW Coupler with valve, Female Thread

Nickel-plated brass or stainless steel, NBR or FKM

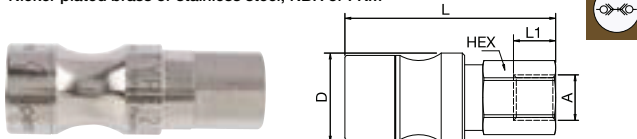

DN	A	Version	HEX	L	L1	D	Version
4	G1/8	204KLIW10MPN	14	45	9	19	Nickel-plated brass
4	G1/8	204KLIW10EVX	14	45	9	19	AISI 316L
4	G1/4	204KLIW13MPN	17	47	9	19	Nickel-plated brass
4	G1/4	204KLIW13EVX	17	47	9	19	AISI 316L
6	G3/8	206KLIW17MPN	22	69	7	25.5	Nickel-plated brass
6	G3/8	206KLIW17EVX	22	69	9	25.5	AISI 316L
6	G1/2	206KLIW21MPN	22	72	10	25.5	Nickel-plated brass
6	G1/2	206KLIW21EVX	24	72	12	25.5	AISI 316L
9	G1/2	209KLIW21MPN	27	92	14	33	Nickel-plated brass
9	G1/2	209KLIW21EVX	27	92	16	33	AISI 316L
9	G3/4	209KLIW26MPN	32	94	14	33	Nickel-plated brass
9	G3/4	209KLIW26EVX	32	94	16	33	AISI 316L

Series 200 - Dry-break



Dry-Break

200SLAW Plug with valve, Male Thread

Nickel-plated brass or stainless steel, NBR or FKM

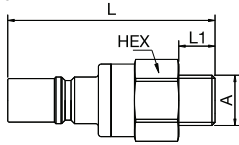

DN	A		HEX	L	L1	Version
4	G1/8	204SLAW10MPN	14	40	7	Nickel-plated brass
4	G1/8	204SLAW10EVX	14	40	7	AISI 316L
4	G1/4	204SLAW13MPN	17	42	9	Nickel-plated brass
4	G1/4	204SLAW13EVX	17	42	9	AISI 316L
6	G3/8	206SLAW17MPN	22	51	9	Nickel-plated brass
6	G3/8	206SLAW17EVX	22	55	9	AISI 316L
6	G1/2	206SLAW21MPN	22	54	12	Nickel-plated brass
6	G1/2	206SLAW21EVX	24	54	12	AISI 316L

200SLIW Plug with valve, Female Thread

Nickel-plated brass or stainless steel, NBR or FKM

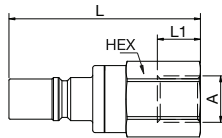

DN	A		HEX	L	L1	Version
4	G1/8	204SLIW10MPN	14	40	9	Nickel-plated brass
4	G1/8	204SLIW10EVX	14	40	9	AISI 316L
4	G1/4	204SLIW13MPN	17	42	7	Nickel-plated brass
4	G1/4	204SLIW13EVX	17	42	9	AISI 316L
6	G3/8	206SLIW17MPN	22	51	7	Nickel-plated brass
6	G3/8	206SLIW17EVX	22	51	9	AISI 316L
6	G1/2	206SLIW21MPN	24	54	10	Nickel-plated brass
6	G1/2	206SLIW21EVX	24	54	12	AISI 316L
9	G1/2	209SLIW21MPN	27	80	14	Nickel-plated brass
9	G1/2	209SLIW21EVX	27	80	16	AISI 316L
9	G3/4	209SLIW26MPN	32	82	14	Nickel-plated brass
9	G3/4	209SLIW26EVX	32	82	16	AISI 316L



Dry-break cartridge couplings without locking mechanism made of stainless steel. Available in five different sizes for modular block/plate assembly in sensitive environments. Different coupling sizes can be combined to one multicoupling depending on the application requirements.



Working Pressure*:
up to 15 bar

Material:

- **Coupling:** Nickel plated brass or Stainless Steel
- **Plug:** Nickel plated brass or Stainless Steel
- **Seals:** NBR or FKM

Working Temperature:

- 20°C up to +100°C (NBR)
- 15°C bis +200°C (FKM)

Flow Rate Water:

- **Series 203:** 1.2 l/min.
- **Series 204:** 4.5 l/min.
- **Series 206:** 8.9 l/min.
- **Series 209:** 27 l/min.
- **Series 212:** 32l/min.
pressure drop 0.5 bar

* maximum static working pressure with design factor 4 to 1.



Dry-Break

200KLIWEK Coupler with valve, Female Thread

Stainless Steel AISI 316 L, FKM

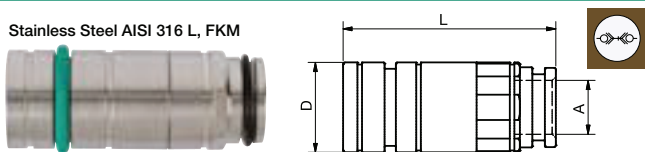

DN	A		L	D
3	G1/16	203KLIW08EVXEK	23	11
4	G1/8	204KLIW10EVXEK	35	16
6	G1/4	206KLIW13EVXEK	54	21
9	G3/8	209KLIW17EVXEK	59	25
12	G1/2	212KLIW21EVXEK	71	32



Dry-Break

200SLIWEK Plug with valve, Female Thread

Stainless Steel AISI 316 L, FKM

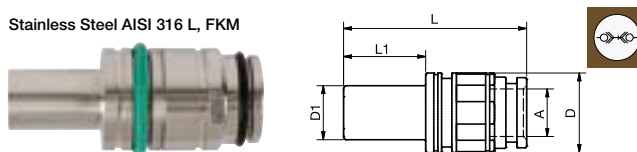

DN	A		L	L1	D	D1
3	G1/16	203SLIW08EVXEK	30	12	11	5.3
4	G1/8	204SLIW10EVXEK	42	15	16	8.4
6	G1/4	206SLIW13EVXEK	51	19	21	12.5
9	G3/8	209SLIW17EVXEK	56	26	25	17
12	G1/2	212SLIW21EVXEK	70	28	30	20

Series 200 - Dry-break - Cartridge Couplings

Technical Features for block- and plate assembly – Tolerances for production of the holder on request.

Block Assembly

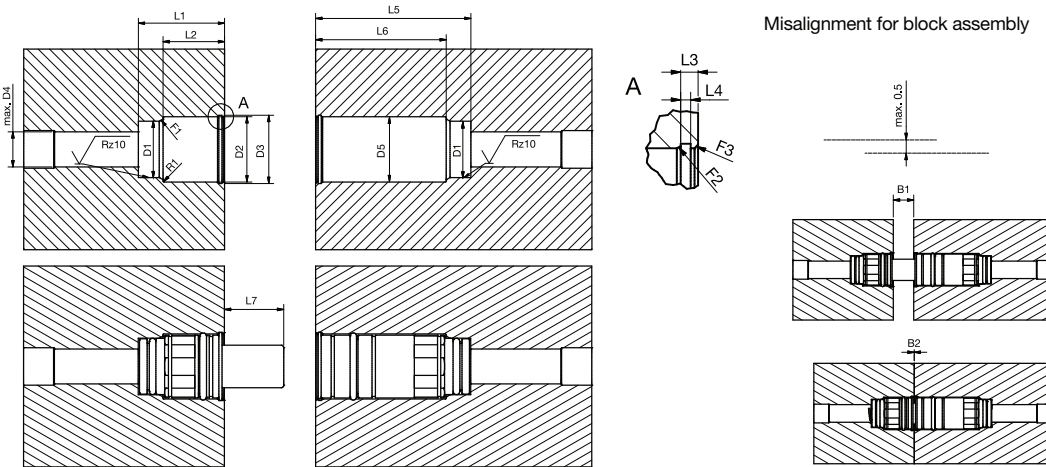
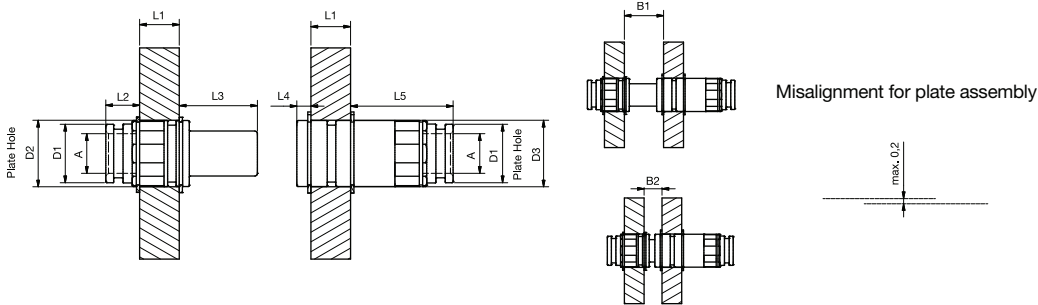

Plate Assembly





Mini industrial coupling with the world's most popular profile in this nominal diameter. Above average flow performance for liquid and gaseous media. It also uses an additional safety locking system. This prevents unintentional disconnection. When being disconnected, the plug must first be pushed further into the coupling before it can be disconnected. Series 21 in brass material without nickel plating and with additional end connections available on request.

- Available on request:
 - in brass material without nickel plating
 - with additional end connections
 - other seals for different temperature ranges and fluids

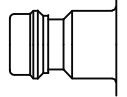

Dust Protections (P. 357)
for Coupling Part.-No. SK16S

KS Single Shut-Off

Working Pressure*:
up to 35 bar

Material:

- Coupling: Nickel plated brass
- Plug: Nickel plated brass
- Seals: NBR

Working Temperature:
-20°C up to +100°C (NBR)

Flow Rate Air:
550 l/min.
inlet pressure 6 bar, pressure drop 0.5 bar

Flow Rate Water:
7 l/min.
pressure drop 0.5 bar

KD Double Shut-Off

Working Pressure*:
up to 35 bar

Material:

- Coupling: Nickel plated brass
- Plug: Nickel plated brass
- Seals: NBR

Working Temperature:
-20°C up to +100°C (NBR)

Flow Rate Air:
310 l/min.
inlet pressure 6 bar, pressure drop 0.5 bar

Flow Rate Water:
2.7 l/min.
pressure drop 0.5 bar

* maximum static working pressure with design factor 4 to 1.

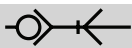

Single Shut-Off

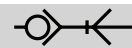

Single Shut-Off

21KSAW Coupler with valve, Male Thread

Nickel-plated brass, NBR

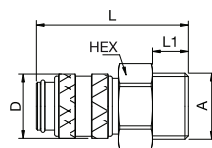
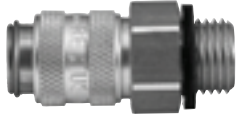

A	HEX	L	L1	D
G1/8 21KSAW10MPN	14	36	7	16
G1/4 21KSAW13MPN	17	38	9	16
G3/8 21KSAW17MPN	19	38	9	16

21KSTF Coupler with valve, Hose Barb

Nickel-plated brass, NBR

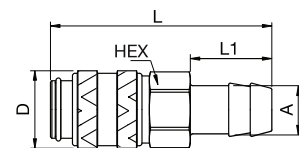
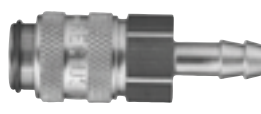

A	HEX	L	L1	D
4 21KSTF04MPN	14	46	17	16
5 21KSTF05MPN	14	46	17	16
6 21KSTF06MPN	14	46	17	16
8 21KSTF08MPN	14	46	17	16
9 21KSTF09MPN	14	46	17	16
10 21KSTF10MPN	14	46	17	16

21KSIW Coupler with valve, Female Thread

Nickel-plated brass, NBR

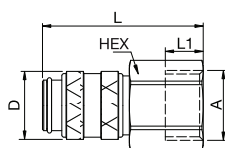

A	HEX	L	L1	D
G1/8 21KSIW10MPN	14	36	9	16
G1/4 21KSIW13MPN	17	38	9	16
G3/8 21KSIW17MPN	19	38	9	16

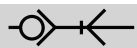

Single Shut-Off



Double Shut-off

21SSAW Plug without valve, Male Thread

Nickel-plated brass

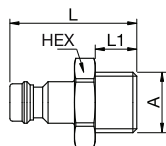
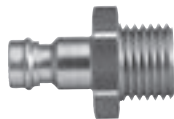

A	HEX	L	L1
G1/8 21SSAW10MXN	14	25	7
G1/4 21SSAW13MXN	17	28	9

21KDAW Coupler with valve, Male Thread

Nickel-plated brass, NBR

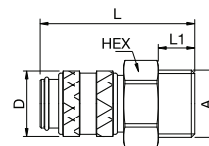

A	HEX	L	L1	D
G1/8 21KDAW10MPN	14	36	7	16
G1/4 21KDAW13MPN	17	38	9	16
G3/8 21KDAW17MPN	19	38	9	16

21SSIW Plug without valve, Female Thread

Nickel-plated brass

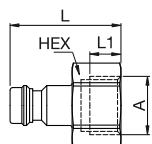

A	HEX	L	L1
G1/8 21SSIW10MXN	14	25	8
G1/4 21SSIW13MXN	17	25	9

21KDIW Coupler with valve, Female Thread

Nickel-plated brass, NBR

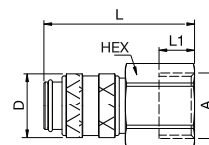

A	HEX	L	L1	D
G1/8 21KDIW10MPN	14	36	9	16
G1/4 21KDIW13MPN	17	38	9	16
G3/8 21KDIW17MPN	19	38	9	16

21SSTF Plug without valve, Hose Barb

Nickel-plated brass

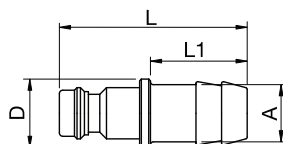

A	L	L1	D
6 21SSTF06MXN	32	17	9
8 21SSTF08MXN	32	17	9
10 21SSTF10MXN	33	17	12

21KDTF Coupler with valve, Hose Barb

Nickel-plated brass, NBR

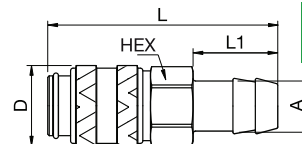

A	HEX	L	L1	D
6 21KDTF06MPN	14	46	17	16
8 21KDTF08MPN	14	46	17	16
10 21KDTF10MPN	14	46	17	16

21SDAW Plug with valve, Male Thread

Nickel-plated brass, NBR

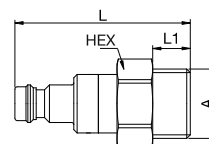

A	HEX	L	L1
G1/8 21SDAW10MPN	14	40	7
G1/4 21SDAW13MPN	17	42	9
G3/8 21SDAW17MPN	19	42	9

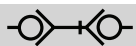

Double Shut-off

21SDIW Plug with valve, Female Thread

Nickel-plated brass, NBR

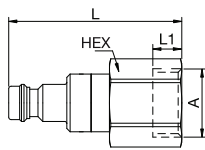

A 

HEX L L1

G1/8	21SDIW10MPN	14	40	7
G1/4	21SDIW13MPN	17	42	7
G3/8	21SDIW17MPN	19	42	7

21SDTF Plug with valve, Hose Barb

Nickel-plated brass, NBR

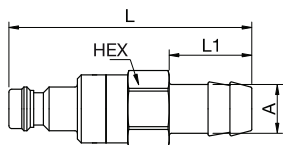

A 

HEX L L1

6	21SDTF06MPN	14	50	17
8	21SDTF08MPN	14	50	17
10	21SDTF10MPN	14	50	17



Safety coupling with UltraFlo-Valve for optimum flow and low pressure drop. The series stands out for its robust design (steel sleeve) and long service life even with the harshest use. Additional safety locking system. This safety lock prevents unintentional disconnection. To disconnect, the plug must first be pushed further into the coupling before it can be unlocked. The brass version has been developed specifically for use with water in the pressure range up to 35 bar.

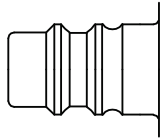

- Available on request:
 - in brass material with and without nickel plating
 - with additional end connections
 - other seals for different temperature ranges and fluids

KS Single Shut-Off

Working Pressure*:
up to 35 bar (Brass-Version)
up to 70 bar (with steel body and steel sleeve)

Material:

- Coupling: Brass / steel or brass
- Plug: Zinc plated steel or brass
- Seals: NBR

Working Temperature:
-20°C up to +100°C (NBR)

Flow Rate Air:
1.800 l/min.
inlet pressure 6 bar, pressure drop 0.5 bar

Flow Rate Water:
28 l/min.
pressure drop 0.5 bar

KD Double Shut-Off

Working Pressure*:
up to 35 bar

Material:

- Coupling: Nickel plated brass
- Plug: Nickel plated brass
- Seals: NBR

Working Temperature:
-20°C up to +100°C (NBR)

Flow Rate Air:
710 l/min.
inlet pressure 6 bar, pressure drop 0.5 bar

Flow Rate Water:
7.1 l/min.
pressure drop 0.5 bar

* maximum static working pressure with design factor 4 to 1.

Single Shut-Off

Single Shut-Off

25KSAK Coupler with valve, Male Thread

Nickel-plated brass/steel, NBR

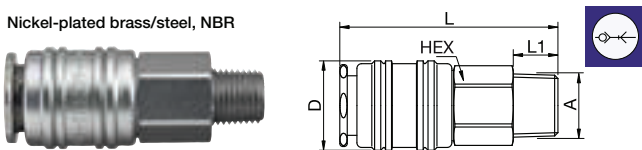

A		HEX	L	L1	D
R1/4	25KSAK13SPN	19	60	12	23
R3/8	25KSAK17SPN	19	60	12	23
R1/2	25KSAK21SPN	22	61	17	23

25KSTF Coupler with valve, Hose Barb

Nickel-plated brass/steel, NBR

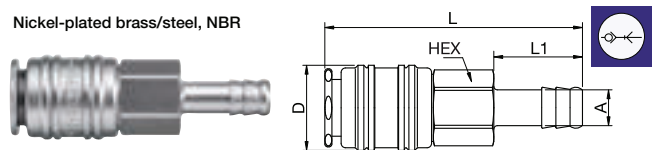

A		HEX	L	L1	D
6	25KSTF06SPN	19	74	25	23
8	25KSTF08SPN	19	74	25	23
9	25KSTF09SPN	19	74	25	23
10	25KSTF10SPN	19	74	25	23
13	25KSTF13SPN	19	74	25	23

25KSIW Coupler with valve, Female Thread

Nickel-plated brass/steel, NBR

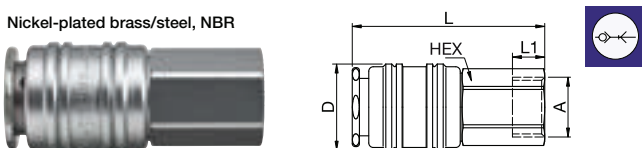

A		HEX	L	L1	D
G1/4	25KSIW13SPN	19	56	10	23
G3/8	25KSIW17SPN	19	55	9	23
G1/2	25KSIW21SPN	24	58	12	23

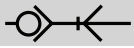

Single Shut-Off

25SSAK Plug without valve, Male Thread

Zinc-plated steel

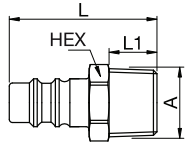

A	HEX	L	L1
R1/4 25SSAK13SXZ	14	37	12
R3/8 25SSAK17SXZ	17	37	12
R1/2 25SSAK21SXZ	22	43	17

25SSIW Plug without valve, Female Thread

Zinc-plated steel

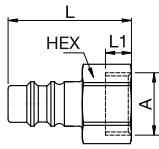

A	HEX	L	L1
G1/4 25SSIW13SXZ	17	33	9
G3/8 25SSIW17SXZ	19	33	9

25SSTF Plug without valve, Hose Barb

Zinc-plated steel

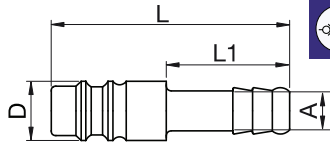

A	L	L1	D
9 25SSTF09SXZ	48	25	12

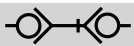

Double Shut-off

25KDAK Coupler with valve, Male Thread

Nickel-plated brass, NBR

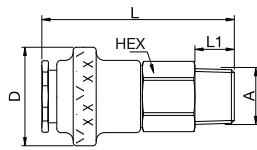

A	HEX	L	L1	D
R1/4 25KDAK13BPN	19	60	12	30
R3/8 25KDAK17BPN	19	60	12	30
R1/2 25KDAK21BPN	22	61	17	30

25KDIW Coupler with valve, Female Thread

Nickel-plated brass, NBR

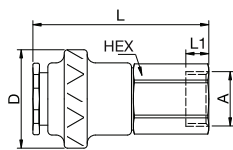

A	HEX	L	L1	D
G1/4 25KDIW13BPN	19	56	10	30
G3/8 25KDIW17BPN	19	55	9	30
G1/2 25KDIW21BPN	24	58	12	30

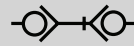

Double Shut-off

25KDTF Coupler with valve, Hose Barb

Nickel-plated brass, NBR

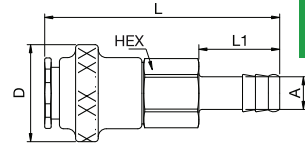

A	HEX	L	L1	D
6 25KDTF06BPN	19	74	25	30
8 25KDTF08BPN	19	74	25	30
9 25KDTF09BPN	19	74	25	30
10 25KDTF10BPN	19	74	25	30
13 25KDTF13BPN	19	74	25	30

25SDAW Plug with valve, Male Thread

Nickel-plated brass, NBR

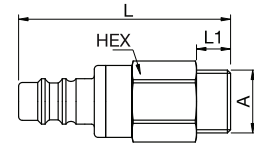

A	HEX	L	L1
G1/4 25SDAW13MPN	22	43	9
G3/8 25SDAW17MPN	22	43	9
G1/2 25SDAW21MPN	22	46	12

25SDIW Plug with valve, Female Thread

Nickel-plated brass, NBR

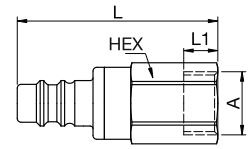

A	HEX	L	L1
G1/4 25SDIW13MPN	22	43	10
G3/8 25SDIW17MPN	22	43	9
G1/2 25SDIW21MPN	24	46	12

25SDTF Plug with valve, Hose Barb

Nickel-plated brass, NBR

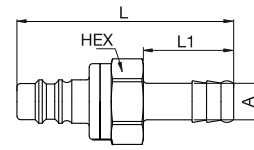

A	HEX	L	L1
6 25SDTF06MPN	21	60	25
8 25SDTF08MPN	21	60	25
9 25SDTF09MPN	21	60	25
10 25SDTF10MPN	21	60	25
13 25SDTF13MPN	21	60	25



This coupling system has been developed specifically for the area of air breathing apparatus. Coupling system with single-hand operation. High Flow valve for optimum flow and low pressure drop. Additional safety locking system. This safety lock prevents unintentional disconnection. To disconnect, the plug must first be pushed further into the coupling before it can be unlocked. Profile cannot be interconnected with the 96KS series. Tested according DIN EN 14593.

- Available on request:
 - with additional end connections
 - other seals for different temperature ranges and fluids

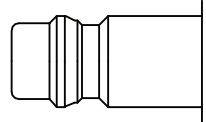

Dust Protections (P. 357)
for Coupling Part.-No. SK23S



Working Pressure*:
up to 35 bar

Material:

- Coupling: Nickel plated brass / AISI 303 or nickel plated brass
- Plug: Nickel plated brass
- Seals: NBR

Working Temperature:
-20°C up to +100°C (NBR)

Flow Rate Air:
1.700 l/min.
inlet pressure 6 bar, pressure drop 0.5 bar

* maximum static working pressure with design factor 4 to 1.

Breathing Air

95KSAK Coupler with valve, Male Thread

Nickel-plated brass or stainless steel, NBR

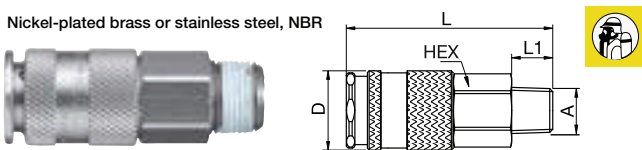

A	Version	HEX	L	L1	D	Version
R1/4	95KSAK13BPN	19	61	12	23	Nickel-plated brass
R1/4	95KSAK13RPN	19	61	12	23	Nickel-plated brass / AISI 303
R3/8	95KSAK17BPN	19	60	12	23	Nickel-plated brass
R3/8	95KSAK17RPN	19	60	12	23	Nickel-plated brass / AISI 303
R1/2	95KSAK21BPN	22	61	17	23	Nickel-plated brass
R1/2	95KSAK21RPN	22	61	17	23	Nickel-plated brass / AISI 303

Breathing Air

95KSIW Coupler with valve, Female Thread

Nickel-plated brass or stainless steel, NBR

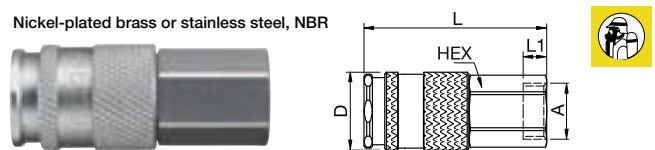

A	Version	HEX	L	L1	D	Version
G1/4	95KSIW13BPN	19	56	10	23	Nickel-plated brass
G1/4	95KSIW13RPN	19	56	10	23	Nickel-plated brass / AISI 303
G3/8	95KSIW17BPN	19	55	9	23	Nickel-plated brass
G3/8	95KSIW17RPN	19	55	9	23	Nickel-plated brass / AISI 303
G1/2	95KSIW21BPN	24	58	12	23	Nickel-plated brass
G1/2	95KSIW21RPN	24	58	12	23	Nickel-plated brass / AISI 303



Breathing Air

95KSTF Coupler with valve, Hose Barb

Nickel-plated brass or stainless steel, NBR

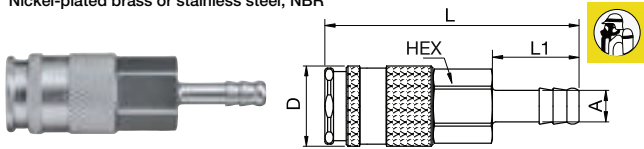

A		HEX	L	L1	D	Version
6	95KSTF06BPN	19	74	25	23	Nickel-plated brass
8	95KSTF08BPN	19	74	25	23	Nickel-plated brass
9	95KSTF09BPN	19	74	25	23	Nickel-plated brass
9	95KSTF09RPN	19	74	25	23	Stainless Steel
10	95KSTF10BPN	19	74	25	23	Nickel-plated brass
10	95KSTF10RPN	19	74	25	23	Stainless Steel
13	95KSTF13BPN	19	74	25	23	Nickel-plated brass

95SSAK Plug without valve, Male Thread

Nickel-plated brass

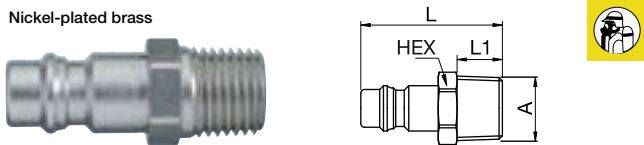

A		HEX	L	L1
R1/4	95SSAK13MXN	14	37.5	12
R3/8	95SSAK17MXN	17	37.5	12

95SSIW Plug without valve, Female Thread

Nickel-plated brass

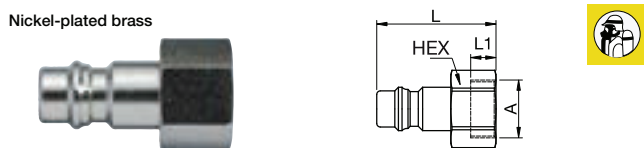

A		HEX	L	L1
G1/4	95SSIW13MXN	17	33	9
G3/8	95SSIW17MXN	19	33	9

95SSTF Plug without valve, Hose Barb

Nickel-plated brass

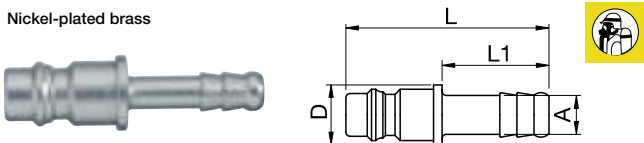

A		L	L1	D
6	95SSTF06MXN	47.5	25	14
9	95SSTF09MXN	47.5	25	14
10	95SSTF10MXN	47.5	25	14



This coupling system has been developed specifically for the area of air breathing apparatus. Coupling system with single-hand operation. High Flow valve for optimum flow and low pressure drop. Additional safety locking system. This safety lock prevents unintentional disconnection. To disconnect, the plug must first be pushed further into the coupling before it can be unlocked. Tested according to DIN EN 14593.

- Available on request:
 - with additional end connections
 - other seals for different temperature ranges and fluids

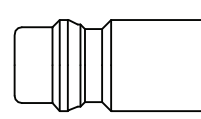

Dust Protections (P. 357)
for Coupling Part.-No. SK23S
for Plug Part.-No. SK12S



Working Pressure*:
up to 35 bar

Material:

- Coupling: Nickel plated brass
- Plug: Nickel plated brass or AISI 303
- Seals: NBR or FKM

Working Temperature:

-20°C up to +100°C (NBR)

Flow Rate Air:

1.700 l/min.

inlet pressure 6 bar, pressure drop 0.5 bar

* maximum static working pressure with design factor 4 to 1.



Breathing Air

96KSAK Coupler with valve, Male Thread

Nickel-plated brass, NBR

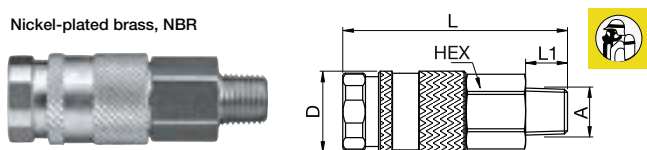

A		HEX	L	L1	D
R1/4	96KSAK13BPN	19	65	12	23
R3/8	96KSAK17BPN	19	64	12	23
R1/2	96KSAK21BPN	22	66	17	23



Breathing Air

96KSTF Coupler with valve, Hose Barb

Nickel-plated brass, NBR

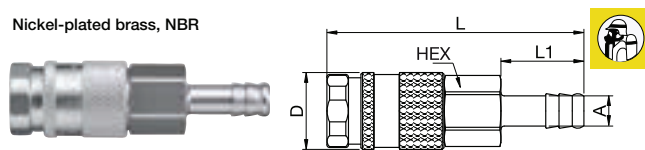

A		HEX	L	L1	D
6	96KSTF06BPN	19	78	25	23
9	96KSTF09BPN	19	78	25	23
10	96KSTF10BPN	19	78	25	23
13	96KSTF13BPN	19	78	25	23

96KSIW Coupler with valve, Female Thread

Nickel-plated brass, NBR

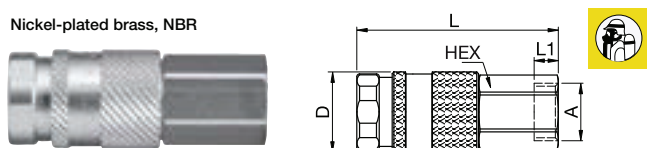

A		HEX	L	L1	D
G1/4	96KSIW13BPN	19	60	10	23
G3/8	96KSIW17BPN	19	59	9	23
G1/2	96KSIW21BPN	24	62	10	23



Breathing Air

96SSA Plug without valve, Male Thread

Nickel-plated brass or stainless steel

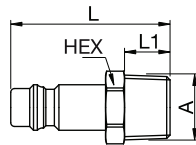

A		HEX	L	L1	Version
R1/4	96SSAK13MXN	14	42	12	Nickel-plated brass
R3/8	96SSAK17MXN	17	42	12	Nickel-plated brass
G3/8	96SSAW17RXX	19	38	9	AISI 303

96SSIW Plug without valve, Female Thread

Nickel-plated brass

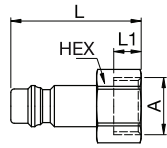

A		HEX	L	L1
G1/4	96SSIW13MXN	17	38	10
G3/8	96SSIW17MXN	19	38	10

96SSTF Plug without valve, Hose Barb

Nickel-plated brass

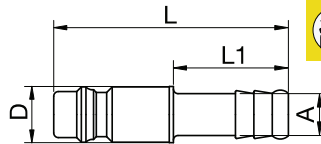

A		L	L1	D
6	96SSTF06MXN	51	25	12
9	96SSTF09MXN	51	25	12
10	96SSTF10MXN	54	25	14



Safety coupling with a self-venting system for ISO 6150 C plug profile. Self-venting takes place during disconnection – no risk of pressurised hoses being tossed around. When the Push-Button is pressed for the first time, air is relieved from the coupling but the plug in the coupling remains locked. The plug is only disconnected when the Push-Button is pressed for the second time. System fulfils the requirements of ISO4414 – increased safety standards in the work place. DIN EN 983. Coupling body is 360° rotating so Push-Button is visible in any position.

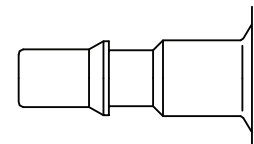

ISO 6150 C Profile



Working Pressure*:
up to 12 bar

Material:

- Coupling: Anodised Aluminium, Nickel plated brass
- Plug: Nickel plated steel
- Seals: NBR

Working Temperature:

-20°C up to +100°C (NBR)

Flow Rate Air:

810 l/min.

inlet pressure 6 bar, pressure drop 0.5 bar

* maximum static working pressure with design factor 4 to 1.



Self-Venting System

18KPAW Coupler with valve, Male Thread

Anodised aluminium, nickel-plated brass

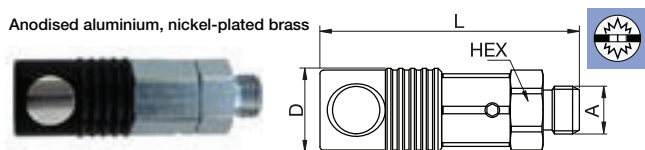

A		HEX	L	D
G1/4	18KPAW13APX	20	71.4	23
G3/8	18KPAW17APX	20	71.4	23
G1/2	18KPAW21APX	22	75.4	23



Self-Venting System

18KPTF Coupler with valve, Hose Barb

Anodised aluminium, nickel-plated brass

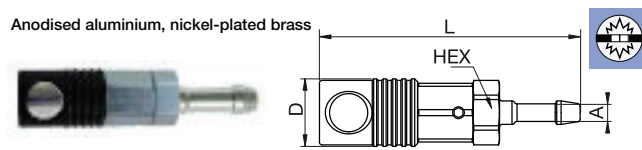

A		HEX	L	D
6	18KPTF06APX	20	88.9	23
8	18KPTF08APX	20	88.9	23
9	18KPTF09APX	20	88.9	23
13	18KPTF13APX	20	88.9	23

18KPIW Coupler with valve, Female Thread

Anodised aluminium, nickel-plated brass

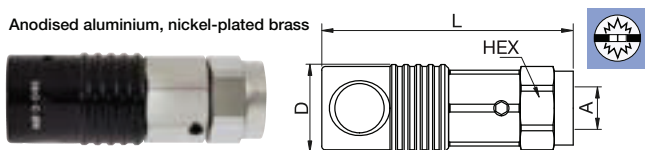

A		HEX	L	D
G1/4	18KPIW13APX	20	66.4	23
G3/8	18KPIW17APX	20	67.4	23
G1/2	18KPIW21APX	24	70.4	23



Self-Venting System

18SFAW Plug without valve, Male Thread

Nickel-plated steel

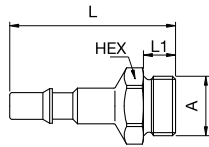

A			HEX	L	L1
G1/4	18SFAW13SXN	9087 18 13	17	41	9
G3/8	18SFAW17SXN	9087 18 17	19	41	9

18SFIW Plug without valve, Female Thread

Nickel-plated steel

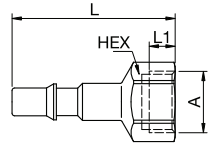

A			HEX	L	L1
G1/4	18SFIW13SXN	9086 18 13	17	43	9
G3/8	18SFIW17SXN	9086 18 17	19	44	9

18SFTF Plug without valve, Hose Barb

Nickel-plated steel

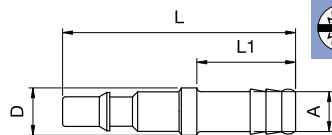

A			L	L1	D
6	18SFTF06SXN	9085 18 06	59	25	12
8	18SFTF08SXN	9085 18 08	59	25	12
10	18SFTF10SXN	9085 18 10	59	25	12
13	18SFTF13SXN		59	25	12



Safety coupling with a self-venting system for ISO 6150 B plug profile. Self-venting takes place during disconnection – no risk of pressurised hoses being tossed around. When the Push-Button is pressed for the first time, air is relieved from the coupling but the plug in the coupling remains locked. The plug is only disconnected when the Push-Button is pressed for the second time. System fulfils the requirements of ISO4414 – increased safety standards in the work place. DIN EN 983. Coupling body is 360° rotating so Push-Button is visible in any position.

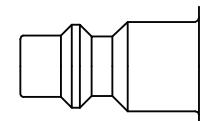

ISO 6150 B Profile



Working Pressure*:
up to 12 bar

Material:

- Coupling: Anodised Aluminium, Nickel plated brass
- Plug: Nickel plated steel
- Seals: NBR

Working Temperature:

-20°C up to +100°C (NBR)

Flow Rate Air:

675 l/min.

inlet pressure 6 bar, pressure drop 0.5 bar

* maximum static working pressure with design factor 4 to 1.



Self-Venting System

24KPAW Coupler with valve, Male Thread

Anodised aluminium, nickel-plated brass

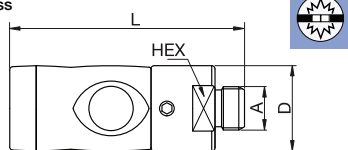

A		HEX	L	D
G1/4	24KPAW13APX	22	71.6	26
G3/8	24KPAW17APX	22	71.6	26
G1/2	24KPAW21APX	22	74.6	26



Self-Venting System

24KPTF Coupler with valve, Hose Barb

Anodised aluminium, nickel-plated brass

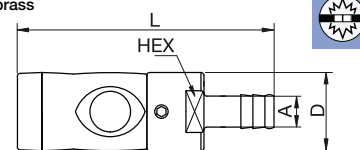

A		HEX	L	D
6	24KPTF06APX	22	85.4	26
8	24KPTF08APX	22	85.4	26
10	24KPTF10APX	22	85.4	26

24KPIW Coupler with valve, Female Thread

Anodised aluminium, nickel-plated brass

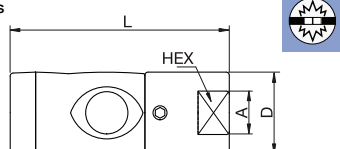

A		HEX	L	D
G1/4	24KPIW13APX	22	70.1	26
G3/8	24KPIW17APX	22	72.1	26
G1/2	24KPIW21APX	22	74.1	26



Self-Venting System

23SFAK Plug without valve, Male Thread

Nickel-plated steel

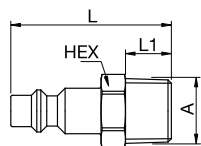

HEX L L1

R1/4	23SFAK13SXN		14	42	12
R3/8	23SFAK17SXN		17	42	12
R1/2	23SFAK21SXN		22	48	17

23SFIW Plug without valve, Female Thread

Nickel-plated steel

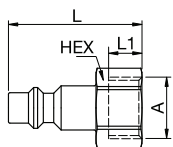

HEX L L1

G1/4	23SFIW13SXN	9086 23 13	17	36	9
G3/8	23SFIW17SXN	9086 23 17	19	36	9
G1/2	23SFIW21SXN	9086 23 21	24	39	12

23SFTF Plug without valve, Hose Barb

Nickel-plated steel

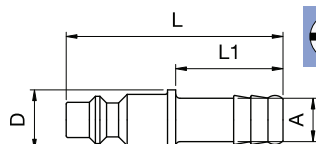

L L1 D

6	23SFTF06SXN	9085 23 06	51	25	14
8	23SFTF08SXN	9085 23 08	51	25	14
10	23SFTF10SXN	9085 23 10	51	25	14



Safety coupling with a self-venting system for Euro plug profile. Self-venting takes place during disconnection – no risk of pressurised hoses being tossed around. When the Push-Button is pressed for the first time, air is relieved from the coupling but the plug in the coupling remains locked. The plug is only disconnected when the Push-Button is pressed for the second time. System fulfils the requirements of ISO4414 – increased safety standards in the work place. DIN EN 983. Coupling body is 360° rotating so Push-Button is visible in any position.

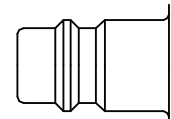

Euro Profile



Working Pressure*:
up to 12 bar

Material:

- Coupling: Anodised Aluminium, Nickel plated brass
- Plug: Zinc plated steel
- Seals: NBR

Working Temperature:

-20°C up to +100°C (NBR)

Flow Rate Air:

1.225 l/min.

inlet pressure 6 bar, pressure drop 0.5 bar

* maximum static working pressure with design factor 4 to 1.



Self-Venting System

26KPAW Coupler with valve, Male Thread

Anodised aluminium, nickel-plated brass

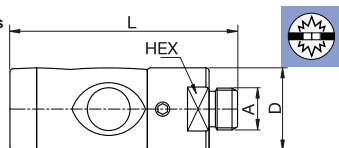

A		HEX	L	D
G1/4	26KPAW13APX	22	71.9	26
G3/8	26KPAW17APX	22	71.9	26
G1/2	26KPAW21APX	22	74.9	26



Self-Venting System

26KPTF Coupler with valve, Hose Barb

Anodised aluminium, nickel-plated brass

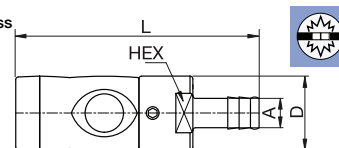

A		HEX	L	D
6	26KPTF06APX	22	85.7	26
8	26KPTF08APX	22	85.7	26
10	26KPTF10APX	22	85.7	26
13	26KPTF13APX	22	85.7	26

26KPIW Coupler with valve, Female Thread

Anodised aluminium, nickel-plated brass

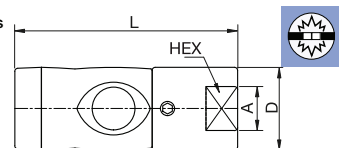

A		HEX	L	D
G1/4	26KPIW13APX	22	70.4	26
G3/8	26KPIW17APX	22	72.4	26
G1/2	26KPIW21APX	22	74.4	26



Self-Venting System

25SFAK Plug without valve, Male Thread

Zinc-plated steel

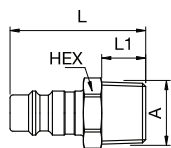

HEX L L1

R1/4	25SFAK13SXZ	14	37	12
R3/8	25SFAK17SXZ	17	37	12
R1/2	25SFAK21SXZ	22	43	17

25SFIW Plug without valve, Female Thread

Zinc-plated steel

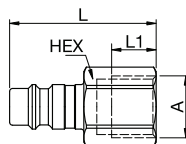

HEX L L1

G1/4	25SFIW13SXZ	9086 25 13	17	38.5	12
G3/8	25SFIW17SXZ	9086 25 17	19	39.5	12
G1/2	25SFIW21SXZ	9086 25 21	24	44	14

25SFTF Plug without valve, Hose Barb

Zinc-plated steel

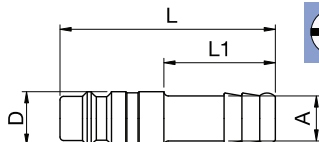

L L1 D

6	25SFTF06SXZ	9085 25 06	48	25	12
8	25SFTF08SXZ	9085 25 08	48	25	12
10	25SFTF10SXZ	9085 25 10	48	25	12
13	25SFTF13SXZ	9085 25 13	48	25	15



Safety coupling with a self-venting system for ISO 6150 B plug profile. Self-venting takes place during disconnection – no risk of pressurised hoses being tossed around. When the Push-Button is pressed for the first time, air is relieved from the coupling but the plug in the coupling remains locked. The plug is only disconnected when the Push-Button is pressed for the second time. System fulfils the requirements of ISO4414 – increased safety standards in the work place. DIN EN 983. Coupling body is 360° rotating so Push-Button is visible in any position

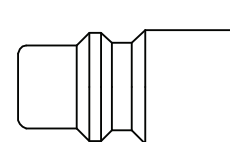

ISO 6150 B Profile



Working Pressure*:
up to 12 bar

Material:

- Coupling: Anodised Aluminium, Nickel plated brass
- Plug: Nickel plated steel
- Seals: NBR

Working Temperature:

-20°C up to +100°C (NBR)

Flow Rate Air:

1.970 l/min.

inlet pressure 6 bar, pressure drop 0.5 bar

* maximum static working pressure with design factor 4 to 1.



Self-Venting System

30KPAW Coupler with valve, Male Thread

Anodised aluminium, nickel-plated brass

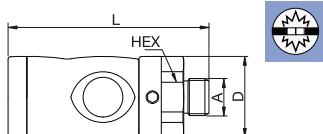

HEX L D

G1/4	30KPAW13APX	27	71.7	29
G3/8	30KPAW17APX	27	70.7	29
G1/2	30KPAW21APX	27	73.7	29



Self-Venting System

30KPTF Coupler with valve, Hose Barb

Anodised aluminium, nickel-plated brass

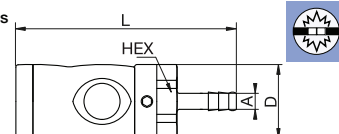

HEX L D

8	30KPTF08APX	27	86.7	29
10	30KPTF10APX	27	86.7	29

30KPIW Coupler with valve, Female Thread

Anodised aluminium, nickel-plated brass

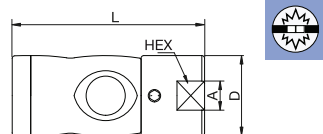

HEX L D

G1/4	30KPIW13APX	23	69.7	29
G3/8	30KPIW17APX	23	71.7	29
G1/2	30KPIW21APX	27	73.7	29



Self-Venting System

30SAW Plug without valve, Male Thread

Nickel-plated steel

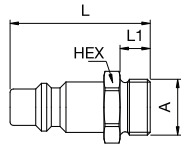

A			HEX	L	L1
G1/4	30SAW13SXN	9087 30 13	17	42	9
G3/8	30SAW17SXN	9087 30 17	19	42	9
G1/2	30SAW21SXN	9087 30 21	24	46	12

30SFIW Plug without valve, Female Thread

Nickel-plated steel

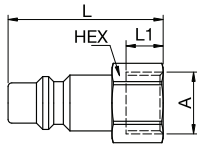

A			HEX	L	L1
G1/4	30SFIW13SXN	9086 30 13	17	40	10
G3/8	30SFIW17SXN	9086 30 17	19	42	10
G1/2	30SFIW21SXN	9086 30 21	24	43	12

30SFTF Plug without valve, Hose Barb

Nickel-plated steel

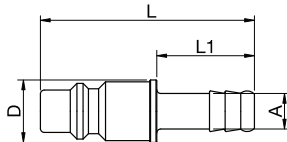

A			L	L1	D
8	30SFTF08SXN	9085 30 08	55	25	16
10	30SFTF10SXN	9085 30 10	55	25	16



Safety coupling with a self-venting system for ISO 6150 C plug profile. Self-venting takes place during disconnection – no risk of pressurised hoses being tossed around. When the Push-Button is pressed for the first time, air is relieved from the coupling but the plug in the coupling remains locked. The plug is only disconnected when the Push-Button is pressed for the second time. System fulfils the requirements of ISO4414 – increased safety standards in the work place. DIN EN 983. Coupling body is 360° rotating so Push-Button is visible in any position

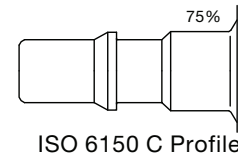

ISO 6150 C Profile



Working Pressure*:
up to 12 bar

Material:

- Coupling: Anodised Aluminium, Nickel plated brass
- Plug: Nickel plated steel
- Seals: NBR

Working Temperature:

-20°C up to +100°C (NBR)

Flow Rate Air:

2.100 l/min.

inlet pressure 6 bar, pressure drop 0.5 bar

* maximum static working pressure with design factor 4 to 1.



Self-Venting System

84KPAW Coupler with valve, Male Thread

Anodised aluminium, nickel-plated brass

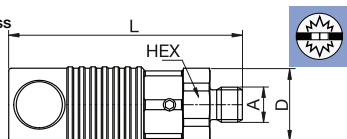

A		HEX	L	D
G1/4	84KPAW13APX	25	86.4	28
G3/8	84KPAW17APX	25	86.4	28
G1/2	84KPAW21APX	25	89.4	28



Self-Venting System

84KPTF Coupler with valve, Hose Barb

Anodised aluminium, nickel-plated brass

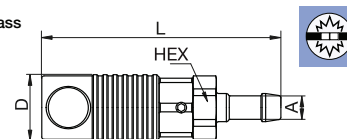

A		HEX	L	D
10	84KPTF10APX	25	101.9	28
13	84KPTF13APX	25	107.4	28

84KPIW Coupler with valve, Female Thread

Anodised aluminium, nickel-plated brass

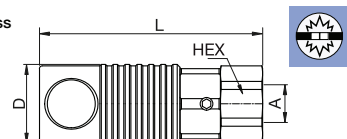

A		HEX	L	D
G1/4	84KPIW13APX	25	79.4	28
G3/8	84KPIW17APX	25	79.4	28
G1/2	84KPIW21APX	25	82.4	28



Self-Venting System

84SFAW Plug without valve, Male Thread

Nickel-plated steel

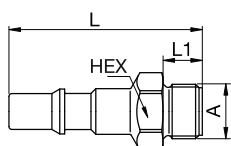

A		HEX	L	L1
G1/4	84SFAW13SXN	17	57	12
G3/8	84SFAW17SXN	21	59	12
G1/2	84SFAW21SXN	21	64	15

84SFIW Plug without valve, Female Thread

Nickel-plated steel

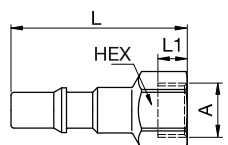

A		HEX	L	L1
G1/4	84SFIW13SXN	17	17	9
G3/8	84SFIW17SXN	19	19	9

84SFTF Plug without valve, Hose Barb

Nickel-plated steel

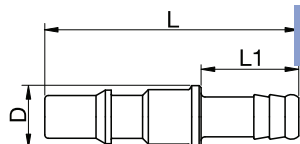

A		L	L1	D
10	84SFTF10SXN	65	25	16
13	84SFTF13SXN	65	25	18



Safety coupling with a self-venting system. Self-venting takes place during disconnection – no risk of pressurised hoses being tossed around. When the sleeve is pulled back, the plug is released yet remains locked in. The coupling valve closes and the air is vented from the air line at the same time. Only then, by operating the sleeve again, can uncoupling take place safely. The system fulfils the requirements of ISO 4414 – increased safety standards in the work place. The plastic sleeve does not scratch working surfaces.

- Available on request:
 - with additional end connections

Safety Note

Reliable functioning can only be guaranteed in conjunction with original Parker Rectus plugs made of steel.

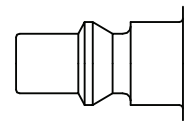

ARO Profile



Self-Venting System

Working Pressure*:

up to 12 bar

Material:

- Coupling: Nickel plated brass
- Plug: Nickel plated steel
- Seals: NBR

Working Temperature:

-20°C up to +60°C (NBR)

Flow Rate Air:

1.400 l/min.

inlet pressure 6 bar, pressure drop 0.5 bar

* maximum static working pressure with design factor 4 to 1.



Self-Venting System

14KEAK Coupler with valve, Male Thread

Nickel-plated brass, NBR

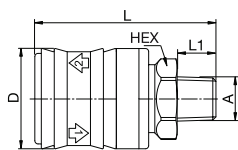

A

HEX L L1 D

R1/4	14KEAK13MPN	22	58	9	31
R3/8	14KEAK17MPN	22	58	9	31
R1/2	14KEAK21MPN	24	63	12	31



Self-Venting System

14KETF Coupler with valve, Hose Barb

Nickel-plated brass, NBR

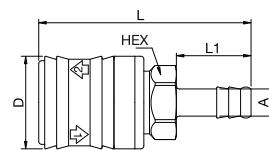

A

HEX L L1 D

6	14KETF06MPN	22	71	25	31
8	14KETF08MPN	22	71	25	31
9	14KETF09MPN	22	71	25	31
10	14KETF10MPN	22	71	25	31
13	14KETF13MPN	22	71	25	31

14KEIW Coupler with valve, Female Thread

Nickel-plated brass, NBR

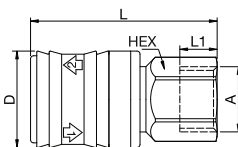

A

HEX L L1 D

G1/4	14KEIW13MPN	22	57	9	31
G3/8	14KEIW17MPN	22	57	9	31
G1/2	14KEIW21MPN	24	60	12	31



Self-Venting System

22SFAK Plug without valve, Male Thread

Nickel-plated steel

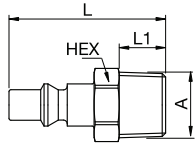

A			HEX	L	L1
R1/8	22SFAK10SXN		12	35	9
R1/4	22SFAK13SXN	9084 22 13	14	41	12
R3/8	22SFAK17SXN	9084 22 17	17	41	12
R1/2	22SFAK21SXN	9084 22 21	22	46	17

22SFIW Plug without valve, Female Thread

Nickel-plated steel

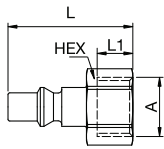

A			HEX	L	L1
G1/4	22SFIW13SXN	9086 22 13	17	35	9
G3/8	22SFIW17SXN	9086 22 17	19	35	10
G1/2	22SFIW21SXN	9086 22 21	24	35	12

22SFTF Plug without valve, Hose Barb

Nickel-plated steel

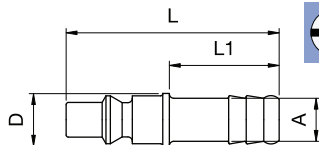

A			L	L1	D
6	22SFTF06SXN	9085 22 06	49	25	12
8	22SFTF08SXN	9085 22 08	49	25	12
9	22SFTF09SXN	9085 22 09	49	25	12
10	22SFTF10SXN	9085 22 10	49	25	12
13	22SFTF13SXN	9085 22 13	49	25	15



Safety coupling 1/4" with a self-venting system according to ISO 6150 B. Self-venting takes place during disconnection – no risk of pressurised hoses being tossed around. When the sleeve is pulled back, the plug is released yet remains locked in. The coupling valve closes and the air is vented from the air line at the same time. Only then, by operating the sleeve again, can uncoupling take place safely. The system fulfils the requirements of ISO 4414 – increased safety standards in the work place. DIN EN 983. Ultra High Flow valve for optimum flow and low pressure drop.

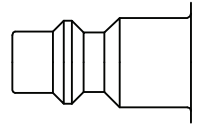

ISO B Profile

- Available on request:
 - with additional end connections

Safety Note

Reliable functioning can only be guaranteed in conjunction with original Parker Rectus plugs made of steel.



Working Pressure*:
up to 12 bar

Material:

- Coupling: Nickel plated brass / steel
- Plug: Nickel plated steel
- Seals: NBR

Working Temperature:

-20°C up to +100°C (NBR)

Flow Rate Air:

950 l/min.

inlet pressure 6 bar, pressure drop 0.5 bar

* maximum static working pressure with design factor 4 to 1.

Self-Venting System

1400KEAW Coupler with valve, Male Thread

Nickel-plated brass/steel, NBR

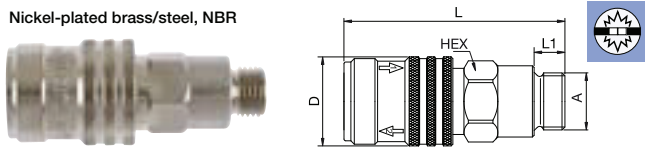

A		HEX	L	L1	D
G1/4	1400KEAW13SPN	19	64.5	9	26
G3/8	1400KEAW17SPN	21	64.5	9	26
G1/2	1400KEAW21SPN	24	67.5	12	26

Self-Venting System

1400KETF Coupler with valve, Hose Barb

Nickel-plated brass/steel, NBR

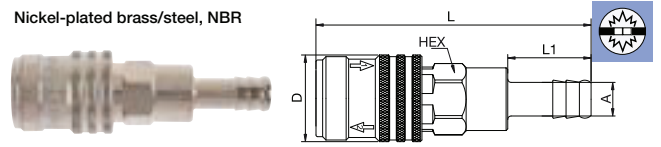

A		HEX	L	L1	D
6	1400KETF06SPN	19	82.5	25	26
8	1400KETF08SPN	19	82.5	25	26
10	1400KETF10SPN	19	82.5	25	26
13	1400KETF13SPN	19	82.5	25	26

1400KEIW Coupler with valve, Female Thread

Nickel-plated brass/steel, NBR

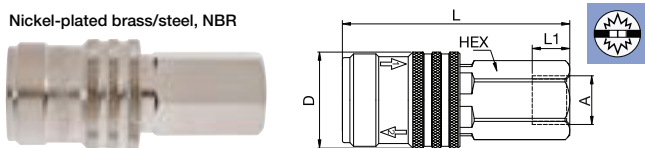

A		HEX	L	L1	D
G1/4	1400KEIW13SPN	19	61.5	9	26
G3/8	1400KEIW17SPN	19	61.5	9	26
G1/2	1400KEIW21SPN	24	64.5	12	26



Self-Venting System

23SFAK Plug without valve, Male Thread

Nickel-plated steel

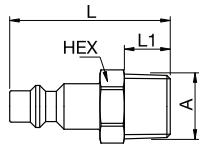

A		HEX	L	L1
R1/8	23SFAK10SXN	13	39	9
R1/4	23SFAK13SXN	14	42	12
R3/8	23SFAK17SXN	17	42	12
R1/2	23SFAK21SXN	22	48	17

23SFIW Plug without valve, Female Thread

Nickel-plated steel

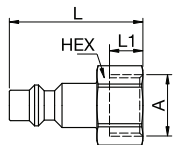

A			HEX	L	L1
G1/8	23SFIW10SXN	9086 23 10	14	36	9
G1/4	23SFIW13SXN	9086 23 13	17	36	9
G3/8	23SFIW17SXN	9086 23 17	19	36	9
G1/2	23SFIW21SXN	9086 23 21	24	39	12

23SFTF Plug without valve, Hose Barb

Nickel-plated steel

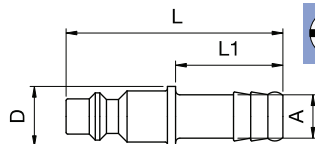

A			L	L1	D
6	23SFTF06SXN	9085 23 06	51	25	14
8	23SFTF08SXN	9085 23 08	51	25	14
9	23SFTF09SXN		51	25	14
10	23SFTF10SXN	9085 23 10	51	25	14
13	23SFTF13SXN		51	25	14



1/4" Safety coupling with a self-venting system according to ISO 6150 B. Self-venting takes place during disconnection – no risk of pressurised hoses being tossed around. When the sleeve is pulled back, the plug is released yet remains locked in. The coupling valve closes and the air is vented from the air line at the same time. Only then, by operating the sleeve again, can uncoupling take place safely. The system fulfils the requirements of ISO 4414 – increased safety standards in the work place. The plastic sleeve does not scratch working surfaces.

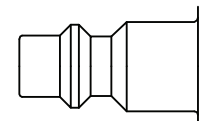

ISO B Profile

- Available on request:
 - with additional end connections

Safety Note

Reliable functioning can only be guaranteed in conjunction with original Parker Rectus plugs made of steel.



KE Self-Venting System

Working Pressure*:
up to 12 bar

Material:

- Coupling: Nickel plated brass
- Plug: Nickel plated steel
- Seals: NBR

Working Temperature:
-20°C up to +60°C (NBR)

Flow Rate Air:
830 l/min.
inlet pressure 6 bar, pressure drop 0.5 bar

* maximum static working pressure with design factor 4 to 1.

Self-Venting System

24KEAK Coupler with valve, Male Thread

Nickel-plated brass, NBR

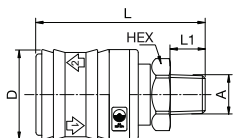

A	HEX	L	L1	D
R1/4 24KEAK13MPN	22	58	9	31
R3/8 24KEAK17MPN	22	58	9	31
R1/2 24KEAK21MPN	24	63	12	31

Self-Venting System

24KETF Coupler with valve, Hose Barb

Nickel-plated brass, NBR

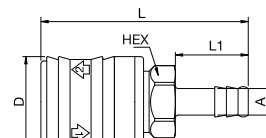

A	HEX	L	L1	D
6 24KETF06MPN	22	71	25	31
8 24KETF08MPN	22	71	25	31
9 24KETF09MPN	22	71	25	31
10 24KETF10MPN	22	71	25	31
13 24KETF13MPN	22	71	25	31

24KEIW Coupler with valve, Female Thread

Nickel-plated brass, NBR

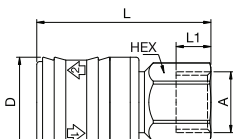

A	HEX	L	L1	D
G1/4 24KEIW13MPN	22	57	9	31
G3/8 24KEIW17MPN	22	57	9	31
G1/2 24KEIW21MPN	24	60	12	31



Self-Venting System

23SFAK Plug without valve, Male Thread

Nickel-plated steel

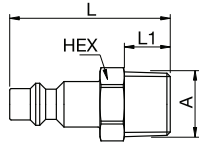

HEX L L1

R1/8	23SFAK10SXN	13	39	9
R1/4	23SFAK13SXN	14	42	12
R3/8	23SFAK17SXN	17	42	12
R1/2	23SFAK21SXN	22	48	17

23SFIW Plug without valve, Female Thread

Nickel-plated steel

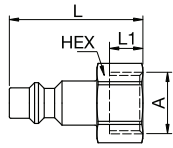

HEX L L1

G1/8	23SFIW10SXN	9086 23 10	14	36	9
G1/4	23SFIW13SXN	9086 23 13	17	36	9
G3/8	23SFIW17SXN	9086 23 17	19	36	9
G1/2	23SFIW21SXN	9086 23 21	24	39	12

23SFTF Plug without valve, Hose Barb

Nickel-plated steel

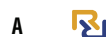
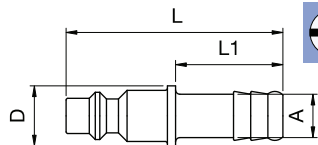

L L1 D

6	23SFTF06SXN	9085 23 06	51	25	14
8	23SFTF08SXN	9085 23 08	51	25	14
9	23SFTF09SXN		51	25	14
10	23SFTF10SXN	9085 23 10	51	25	14
13	23SFTF13SXN		51	25	14



Safety coupling with a self-venting system according to ISO 6150 B. Self-venting takes place during disconnection – no risk of pressurised hoses being tossed around. When the sleeve is pulled back, the plug is released yet remains locked in. The coupling valve closes and the air is vented from the air line at the same time. Only then, by operating the sleeve again, can uncoupling take place safely. The system fulfils the requirements of ISO 4414 – increased safety standards in the work place. The plastic sleeve does not scratch working surfaces.

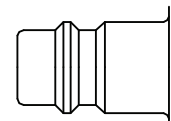

Euro Profile

- Available on request:
 - with additional end connections

Safety Note

Reliable functioning can only be guaranteed in conjunction with original Parker Rectus plugs made of steel.



KE Self-Venting System

Working Pressure*:
up to 12 bar

Material:

- Coupling: Nickel plated brass
- Plug: Nickel plated steel
- Seals: NBR

Working Temperature:
-20°C up to +60°C (NBR)

Flow Rate Air:
830 l/min.
inlet pressure 6 bar, pressure drop 0.5 bar

* maximum static working pressure with design factor 4 to 1.



Self-Venting System

26KEAW Coupler with valve, Male Thread

Nickel-plated brass, NBR

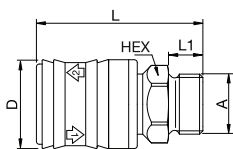

A		HEX	L	L1	D
G1/4	26KEAW13MPN	22	55	9	31
G3/8	26KEAW17MPN	22	55	9	31
G1/2	26KEAW21MPN	24	58	12	31



Self-Venting System

26KETF Coupler with valve, Hose Barb

Nickel-plated brass, NBR

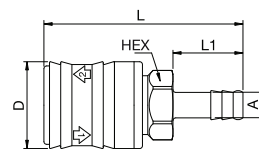

A		HEX	L	L1	D
6	26KETF06MPN	22	71	25	31
8	26KETF08MPN	22	71	25	31
9	26KETF09MPN	22	71	25	31
10	26KETF10MPN	22	71	25	31
13	26KETF13MPN	22	71	25	31

26KEIW Coupler with valve, Female Thread

Nickel-plated brass, NBR

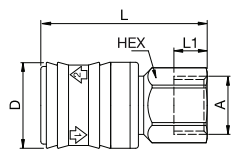

A		HEX	L	L1	D
G1/4	26KEIW13MPN	22	57	9	31
G3/8	26KEIW17MPN	22	57	9	31
G1/2	26KEIW21MPN	24	60	12	31



Self-Venting System

25SFAK Plug without valve, Male Thread

Zinc-plated steel

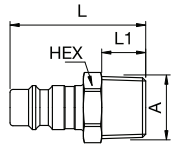

A		HEX	L	L1
R1/8	25SFAK10SXZ	13	33	9
R1/4	25SFAK13SXZ	14	37	12
R3/8	25SFAK17SXZ	17	37	12
R1/2	25SFAK21SXZ	22	43	17

25SFIW Plug without valve, Female Thread

Zinc-plated steel

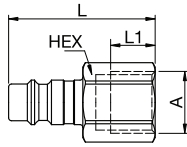
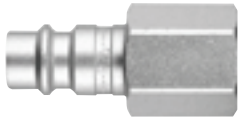

A			HEX	L	L1
G1/8	25SFIW10SXZ	9086 25 10	14	30	5
G1/4	25SFIW13SXZ	9086 25 13	17	38.5	12
G3/8	25SFIW17SXZ	9086 25 17	19	39.5	12
G1/2	25SFIW21SXZ	9086 25 21	24	44	14

25SFTF Plug without valve, Hose Barb

Zinc-plated steel

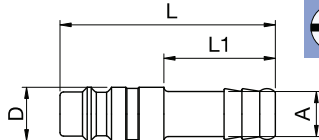

A			L	L1	D
6	25SFTF06SXZ	9085 25 06	48	25	12
8	25SFTF08SXZ	9085 25 08	48	25	12
9	25SFTF09SXZ	9085 25 09	48	25	12
10	25SFTF10SXZ	9085 25 10	48	25	12
13	25SFTF13SXZ	9085 25 13	48	25	15



Safety coupling with a self-venting system. Self-venting takes place during disconnection – no risk of pressurised hoses being tossed around. When the sleeve is pulled back, the plug is released yet remains locked in. The coupling valve closes and the air is vented from the air line at the same time. Only then, by operating the sleeve again, can uncoupling take place safely. The system fulfils the requirements of ISO 4414 – increased safety standards in the work place. DIN EN 983. Ultra High Flow valve for optimum flow and low pressure drop.

- Available on request:
 - with additional end connections

Safety Note

Reliable functioning can only be guaranteed in conjunction with original Parker Rectus plugs made of steel.

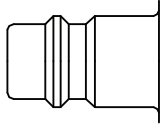

Euro Profile



KE Self-Venting System

Working Pressure*:
up to 12 bar

Material:

- Coupling: Nickel plated brass / steel
- Plug: Zinc plated steel
- Seals: NBR

Working Temperature:
-20°C up to +100°C (NBR)

Flow Rate Air:
2.020 l/min.
inlet pressure 6 bar, pressure drop 0.5 bar

* maximum static working pressure with design factor 4 to 1.

Self-Venting System

1600KEAK Coupler with valve, Male Thread

Nickel-plated brass/steel, NBR

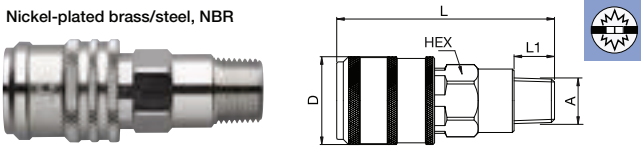

A		HEX	L	L1	D
R1/4	1600KEAK13SPN	19	64.5	12	26
R3/8	1600KEAK17SPN	19	64.5	12	26
R1/2	1600KEAK21SPN	22	59	17	26

Self-Venting System

1600KETF Coupler with valve, Hose Barb

Nickel-plated brass/steel, NBR

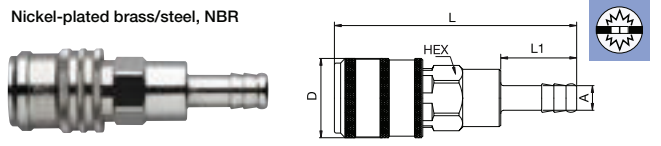

A		HEX	L	L1	D
6	1600KETF06SPN	19	79.5	25	26
8	1600KETF08SPN	19	79.5	25	26
9	1600KETF09SPN	19	79.5	25	26
10	1600KETF10SPN	19	79.5	25	26
13	1600KETF13SPN	19	79.5	25	26

1600KEIW Coupler with valve, Female Thread

Nickel-plated brass/steel, NBR

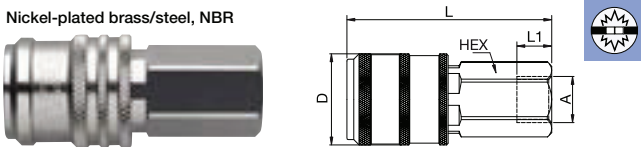

A		HEX	L	L1	D
G1/4	1600KEIW13SPN	19	59	10	26
G3/8	1600KEIW17SPN	19	59	9	26
G1/2	1600KEIW21SPN	24	61.5	12	26



Self-Venting System

25SFAK Plug without valve, Male Thread

Zinc-plated steel

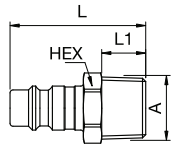

A		HEX	L	L1
R1/8	25SFAK10SXZ	13	33	9
R1/4	25SFAK13SXZ	14	37	12
R3/8	25SFAK17SXZ	17	37	12
R1/2	25SFAK21SXZ	22	43	17

25SFIW Plug without valve, Female Thread

Zinc-plated steel

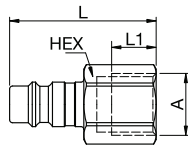

A			HEX	L	L1
G1/8	25SFIW10SXZ	9086 25 10	14	30	5
G1/4	25SFIW13SXZ	9086 25 13	17	38.5	12
G3/8	25SFIW17SXZ	9086 25 17	19	39.5	12
G1/2	25SFIW21SXZ	9086 25 21	24	44	14

25SFTF Plug without valve, Hose Barb

Zinc-plated steel

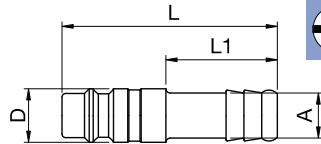

A			L	L1	D
6	25SFTF06SXZ	9085 25 06	48	25	12
8	25SFTF08SXZ	9085 25 08	48	25	12
9	25SFTF09SXZ	9085 25 09	48	25	12
10	25SFTF10SXZ	9085 25 10	48	25	12
13	25SFTF13SXZ	9085 25 13	48	25	15



Safety coupling with a self-venting system. Self-venting takes place during disconnection – no risk of pressurised hoses being tossed around. When the sleeve is pulled back, the plug is released yet remains locked in. The coupling valve closes and the air is vented from the air line at the same time. Only then, by operating the sleeve again, can uncoupling take place safely. The system fulfils the requirements of ISO 4414 – increased safety standards in the work place. DIN EN 983. Ultra High Flow valve for optimum flow and low pressure drop.

- Available on request:
 - with additional end connections

Safety Note

Reliable functioning can only be guaranteed in conjunction with original Parker Rectus plugs made of steel.

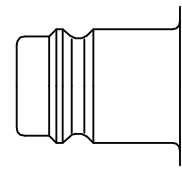

Euro Profile



Working Pressure*:
up to 12 bar

Material:

- Coupling: Nickel plated brass / steel
- Plug: Nickel plated steel
- Seals: NBR

Working Temperature:

-20°C up to +100°C (NBR)

Flow Rate Air:

3.500 l/min.

inlet pressure 6 bar, pressure drop 0.5 bar

* maximum static working pressure with design factor 4 to 1.



Self-Venting System

1700KEAW Coupler with valve, Male Thread

Nickel-plated brass/steel, NBR

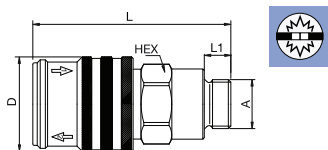

A	HEX	L	L1	D
G3/8 1700KEAW17SPN	24	67	9	32
G1/2 1700KEAW21SPN	24	70	12	32
G3/4 1700KEAW26SPN	30	74	16	32



Self-Venting System

27SFAK Plug without valve, Male Thread

Nickel-plated steel

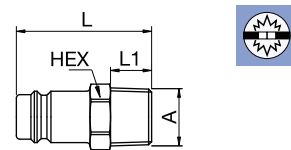

A	HEX	L	L1
R1/4 27SFAK13SXN	17	40	12
R3/8 27SFAK17SXN	17	40	12
R1/2 27SFAK21SXN	22	45	17
R3/4 27SFAK26SXN	27	48	19

1700KEIW Coupler with valve, Female Thread

Nickel-plated brass/steel, NBR

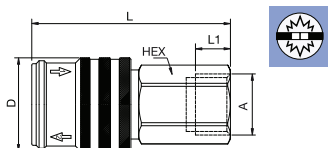

A	HEX	L	L1	D
G3/8 1700KEIW17SPN	24	64.5	12	32
G1/2 1700KEIW21SPN	24	68	12	32
G3/4 1700KEIW26SPN	32	74	16	32

27SFIW Plug without valve, Female Thread

Nickel-plated steel

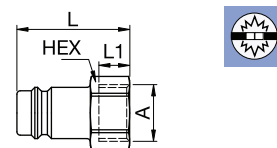

A	HEX	L	L1
G1/4 27SFIW13SXN	17	33	9
G3/8 27SFIW17SXN	19	33	9
G1/2 27SFIW21SXN	24	37	12
G3/4 27SFIW26SXN	32	42	16



Self-Venting System

27SFTF Plug without valve, Hose Barb

Nickel-plated steel

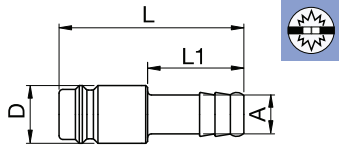

A			L	L1	D
6		27SFTF06SXN	48	25	15
8		27SFTF08SXN	9085 27 08	48	25
9		27SFTF09SXN	48	25	15
10		27SFTF10SXN	9085 27 10	48	25
13		27SFTF13SXN	9085 27 13	48	25
16		27SFTF16SXN	49	25	18
19		27SFTF19SXN	9085 27 19	49	25



The range of ergonomic polymer couplers has been designed for the safety of operators and machinery while giving very high energy efficiency performance. Available in three profile standards, it is perfectly suited for any type of installation.

Safety Note

Prevents risk of whiplash, the quick-acting vent allows disconnection to be carried out in total safety.

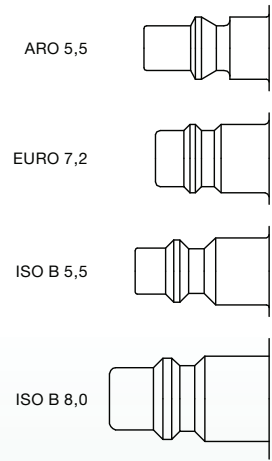

Working Pressure*:
up to 16 bar

Material:

- **Coupling:** Technical polymer or aluminium, nickel plated brass, stainless steel
- **Plug:** Nickel plated steel
- **Seals:** NBR

Working Temperature:

-20°C up to +60°C (NBR)

Flow Rate Air:

- **ARO 5.5:** 1.250 l/min.
 - **Euro 7.2:** 2.000 l/min.
 - **ISO B 5.5:** 1.250 l/min.
 - **ISO B 8,0:** 2.400 l/min.
- inlet pressure 6 bar, pressure drop 0.5 bar

* maximum static working pressure with design factor 4 to 1.

Part Numbers Structure

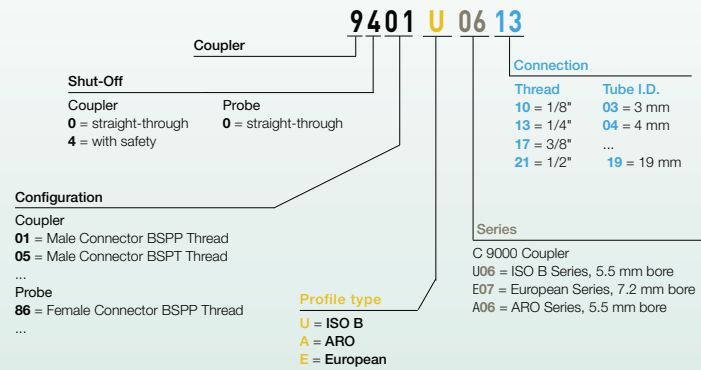

Self-Venting System

9401A Coupler with valve, Male BSPP Thread

Technical polymer, Nickel-plated brass, NBR

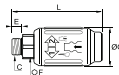

DN	C		E	F	G	L	Kg
5.5	G1/4	9401A06 13	6.5	17	31.5	70.5	
5.5	G3/8	9401A06 17	9	21	31.5	73.5	
5.5	G1/2	9401A06 21	9	25	31.5	70.5	

C9000 series: single shut-off = 1250 NI/min



Self-Venting System

9414A Coupler with valve, Female BSPP Thread

Technical polymer, Nickel-plated brass, NBR

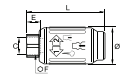

DN	C		E	F	G	L	Kg
5.5	G1/4	9414A06 13	12	17	31.5	64.5	
5.5	G3/8	9414A06 17	12	22	31.5	70	
5.5	G1/2	9414A06 21	15	27	31.5	76	

Series C9000 series: single shut-off = 1250 NI/min

9405A Coupler with valve, Male BSPT Thread

Technical polymer, Nickel-plated brass, NBR

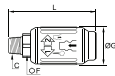

DN	C		F	G	L	Kg
5.5	R1/4	9405A06 13	17	31.5	73	
5.5	R3/8	9405A06 17	19	31.5	74.5	
5.5	R1/2	9405A06 21	22	31.5	79.5	

Series C9000 series: single shut-off = 1250 NI/min

9410A Coupler with valve, LF 3000® Push-In Connection, Spiral Protection Spring

Technical polymer, Nickel-plated brass, NBR

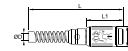

DN	ØD		G	L	L1	Kg
5.5	8	9410A06 08	31.5	143	54	
5.5	10	9410A06 10	31.5	143	54	

Series C9000 series: single shut-off = 1250 NI/min



Self-Venting System

9421A Coupler with valve, with Hosetail

Technical polymer, Nickel-plated brass, NBR

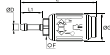

DN	ØD		F	G	L	L1	Kg
5.5	6	9421A06 06	17	31.5	86.5	26	
5.5	8	9421A06 08	17	31.5	86.5	26	
5.5	10	9421A06 10	17	31.5	86.5	26	

Series C9000 series: single shut-off = 1250 NI/min

9416A Coupler with valve, Bulkhead Mountable, Female BSPP Thread

Technical polymer, Nickel-plated brass, NBR

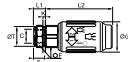

DN	C		E	F	G	K	L1	L2	ØT	Kg
5.5	G1/4	9416A06 13	12	22	31.5	6	12.5	66.5	18.5	

Series C9000 series: single shut-off = 1250 NI/min

9440A Y Coupler, Female BSPP Thread

Technical polymer, Nickel-plated brass, NBR

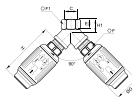

DN	C		E	F	F1	G	H	H1	Kg
5.5	G3/8	9440A06 17	11.5	19	20	31.5	68	16	

Series C9000 series: single shut-off = 1250 NI/min

9087A Plug without valve, Male BSPP Thread

Nickel-plated steel, technical polymer



DN	C		E	F	L	L1	Kg
5.5	G1/4	9087A06 13	9	17	36	22	
5.5	G3/8	9087A06 17	9	19	36	22	
5.5	G1/2	9087A06 21	12	24	40	22	

Probe without shut-off



Self-Venting System

9080A Plug without valve, LF 3000® Push-In Connection, with Spiral Protection Spring

Nickel-plated steel, NBR

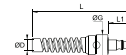

DN	ØD		G	L	L1	Kg
5.5	8	9080A06 08	24	118	22	
5.5	10	9080A06 10	24	118	22	

Probe without shut-off

9094A Plug without valve, with Hosetail

Nickel-plated steel

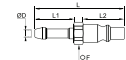

DN	ØD		F	L	L1	L2	Kg
5.5	6	9094A06 06	14	48.5	22	25	
5.5	8	9094A06 08	14	48.5	22	25	
5.5	10	9094A06 10	14	48.5	22	25	

Probe without shut-off

9401E Coupler with valve, Male BSPP Thread

Technical polymer, Nickel-plated brass, NBR

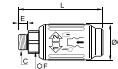

DN	C		E	F	G	L	Kg
7.2	G1/4	9401E07 13	6.5	22	36.5	80	
7.2	G3/8	9401E07 17	7.5	22	36.5	81	
7.2	G1/2	9401E07 21	9	25	36.5	83.5	

Series C9000: single shut-off = 2000 NI/min

9414E Coupler with valve, Female BSPP Thread

Technical polymer, Nickel-plated brass, NBR

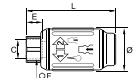

DN	C		E	F	G	L	Kg
7.2	G1/4	9414E07 13	12	22	36.5	73	
7.2	G3/8	9414E07 17	12	22	36.5	73	
7.2	G1/2	9414E07 21	15	27	36.5	78	

Series C9000: single shut-off = 2000 NI/min

Series C9000 - Self-Venting Turning Motion Technology



Self-Venting System

9410E Coupler with valve, LF 3000® Push-In Connection, Spiral Protection Spring

Technical polymer, Nickel-plated brass, NBR



DN	ØD		G	L	L1	Kg
7.2	10	9410E07 10	36.5	151	63	
7.2	12	9410E07 12	36.5	151	63	

Series C9000: single shut-off = 2000 NI/min

9421E Coupler with valve, with Hosetail

Technical polymer, Nickel-plated brass, NBR

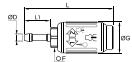

DN	ØD		F	G	L	L1	Kg
7.2	8	9421E07 08	22	36.5	93	26	
7.2	10	9421E07 10	22	36.5	93	26	
7.2	13	9421E07 13	22	36.5	97	30	

Series C9000: single shut-off = 2000 NI/min

9416E Coupler with valve, Bulkhead Mountable, Female BSPP Thread

Technical polymer, Nickel-plated brass, NBR

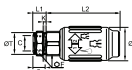

DN	C		E	F	G	K max	L1	L2	ØT min	Kg
7.2	G3/8	9416E07 17	12	24	36.5	7	14.5	74	22.5	

Series C9000: single shut-off = 2000 NI/min

9440E Y Coupler, Female BSPP Thread

Technical polymer, Nickel-plated brass, NBR

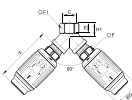

DN	C		E	F	F1	G	H	H1	Kg
7.2	G1/2	9440E07 21	14	25	25	36.5	78	19	

Series C9000: single shut-off = 2000 NI/min



Self-Venting System

9087E Plug without valve, Male BSPP Thread

Nickel-plated steel, technical polymer



DN	C		E	F	L	L1	Kg
7.2	G1/4	9087E07 13	9	14	34	20	
7.2	G3/8	9087E07 17	9	17	34	20	
7.2	G1/2	9087E07 21	12	22	38	20	

Probe without shut-off

9080E Plug without valve, LF 3000® Push-In Connection, with Spiral Protection Spring

Nickel-plated steel, NBR

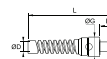

DN	ØD		G	L	L1	Kg
7.2	10	9080E07 10	24	114	20	
7.2	12	9080E07 12	29.5	125	20	

Probe without shut-off

9094E Plug without valve, with Hosetail

Nickel-plated steel

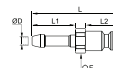

DN	ØD		F	L	L1	L2	Kg
7.2	8	9094E07 08	17	48	20	25	
7.2	10	9094E07 10	17	48	20	25	
7.2	13	9094E07 13	17	48	20	25	

Probe without shut-off

9401U Coupler with valve, Male BSPP Thread

Technical polymer, Nickel-plated brass, NBR

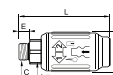

DN	C		E	F	G	L	Kg
5.5	G1/4	9401U06 13	7.5	17	31.5	74	
5.5	G3/8	9401U06 17	8.5	21	31.5	76.5	
5.5	G1/2	9401U06 21	10.5	25	31.5	80	
8	G1/4	9401U08 13	6.5	22	36.5	81.5	
8	G3/8	9401U08 17	7.5	22	36.5	82.5	
8	G1/2	9401U08 21	9	25	36.5	85.5	

Series C9000 ISO B6: single shut-off = 1250 NI/min
Series C9000 ISO B8: single shut-off = 2400 NI/min



Self-Venting System

9405U Coupler with valve, Male BSPT Thread

Technical polymer, Nickel-plated brass, NBR

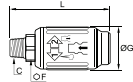

DN	C		F	G	L	Kg
5.5	R1/4	9405U06 13	17	31.5	75	
5.5	R3/8	9405U06 17	19	31.5	76.5	
5.5	R1/2	9405U06 21	22	31.5	81.5	
8	R1/4	9405U08 13	22	36.5	84	
8	R3/8	9405U08 17	22	36.5	84	
8	R1/2	9405U08 21	22	36.5	88	

Series C9000 ISO B6: single shut-off = 1250 NI/min
Series C9000 ISO B8: single shut-off = 2400 NI/min



Self-Venting System

9421U Coupler with valve, with Hosetail

Technical polymer, Nickel-plated brass, NBR

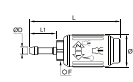

DN	ØD		F	G	L	L1	Kg
5.5	6	9421U06 06	17	31.5	88.5	26	
5.5	8	9421U06 08	17	31.5	88.5	26	
5.5	10	9421U06 10	17	31.5	88.5	26	
8	6	9421U08 06	22	36.5	95	26	
8	8	9421U08 08	22	36.5	95	26	
8	10	9421U08 10	22	36.5	95	26	
8	13	9421U08 13	22	36.5	99	30	

Series C9000 ISO B6: single shut-off = 1250 NI/min
Series C9000 ISO B8: single shut-off = 2400 NI/min

9414U Coupler with valve, Female BSPP Thread

Technical polymer, Nickel-plated brass, NBR

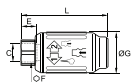

DN	C		E	F	G	L	Kg
5.5	G1/4	9414U06 13	12	17	31.5	66.5	
5.5	G3/8	9414U06 17	12	22	31.5	72	
5.5	G1/2	9414U06 21	15	27	31.5	78	
8	G1/4	9414U08 13	12	22	36.5	75	
8	G3/8	9414U08 17	12	22	36.5	75	
8	G1/2	9414U08 21	15	27	36.5	80	

Series C9000 ISO B6: single shut-off = 1250 NI/min
Series C9000 ISO B8: single shut-off = 2400 NI/min

9416U Coupler with valve, Bulkead Mountable, Female BSPP Thread

Technical polymer, Nickel-plated brass, NBR

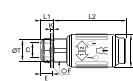

DN	C		E	F	G	K max	L1	L2	ØT min	Kg
5.5	G1/4	9416U06 13	12	22	31.5	6	12.5	68.5	18.5	
8	G3/8	9416U08 17	12	24	36.5	7	14.5	76	22.5	

Series C9000 ISO B6: single shut-off = 1250 NI/min
Series C9000 ISO B8: single shut-off = 2400 NI/min

9410U Coupler with valve, LF 3000® Push-In Connection Body Spiral Protection Spring

Technical polymer, Nickel-plated brass, NBR

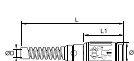

DN	ØD		G	L	L1	Kg
5.5	8	9410U06 08	31.5	145	56	
5.5	10	9410U06 10	31.5	145	56	
8	10	9410U08 10	36.5	155	63	
8	12	9410U08 12	36.5	165	63	

Series C9000 ISO B6: single shut-off = 1250 NI/min
Series C9000 ISO B8: single shut-off = 2400 NI/min

9440U Y Coupler, Female BSPP Thread

Technical polymer, Nickel-plated brass, NBR

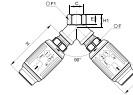

DN	C		E	F	F1	G	H	H1	Kg
5.5	G3/8	9440U06 17	11.5	19	20	31.5	70	16	
8	G1/2	9440U08 21	14	22	25	36.5	80	19	

Series C9000 ISO B6: single shut-off = 1250 NI/min
Series C9000 ISO B8: single shut-off = 2400 NI/min



Self-Venting System

9087U Plug without valve, Male BSPP Thread

Nickel-plated steel, technical polymer

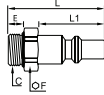

DN	C		E	F	L	L1	Kg
5.5	G1/4	9087U06 13	7	16	37	24	
5.5	G3/8	9087U06 17	7	20	37	24	
5.5	G1/2	9087U06 21	9	24	39	24	
8	G1/4	9087U08 13	7	16	38	26	
8	G3/8	9087U08 17	7	20	39	26	
8	G1/2	9087U08 21	9	24	42	26	

Probe without shut-off

9086U Plug without valve, Female BSPP Thread

Treated steel

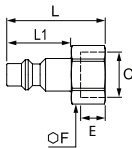

DN	C		E	F	L	L1	Kg
5.5	G3/8	9086 23 17	9	19	36	24	

Probe without shut-off30 Series probe (DN 8.5) compatible with ISO B series C 9000 couplers (DN 8)

9080U Plug without valve, LF 3000® Push-In Connection, with Spiral Protection Spring

Nickel-plated steel, NBR

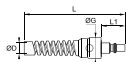

DN	ØD		G	L	L1
5.5	8	9080U06 08	24	112	24
5.5	10	9080U06 10	24	112	24
8	10	9080U08 10	24	114	26
8	12	9080U08 12	29.5	125	26

Probe without shut-off

9094U Plug without valve, with Hosetail

Nickel-plated steel

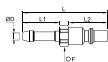

DN	ØD		F	L	L1	L2
5.5	6	9094U06 06	14	51	24	25
5.5	8	9094U06 08	14	51	27	25
5.5	10	9094U06 10	14	51	24	25
8	8	9094U08 08	17	51	24	25
8	10	9094U08 10	17	51	27	25
8	13	9094U08 13	17	51	24	25

Probe without shut-off



Coded industrial coupling system developed on the basis of series 21 with above-average flow rate for liquid and gaseous media. Coupling system with single-hand operation. The mechanical coding of the coupling and plug offers a guarantee for avoiding mix-ups between media when coupling, which is complemented by the color coding of the anodised sleeves.

- Available on request:
 - Double shut-off version

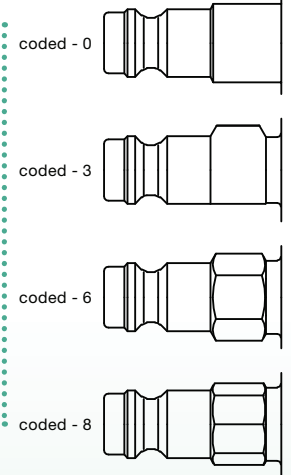

KA Single Shut-Off

Working Pressure*:
up to 12 bar

Material:

- Coupling: Brass or nickel plated brass
- Plug: Nickel plated brass
- Seals: NBR

Working Temperature:
-20°C up to +100°C (NBR)

Flow Rate Air:

550 l/min.
inlet pressure 6 bar, pressure drop 0.5 bar

Flow Rate Water:

7 l/min.
pressure drop 0.5 bar

KB Double Shut-Off

Working Pressure*:
up to 35 bar

Material:

- Coupling: Brass
- Plug: Brass
- Seals: NBR

Working Temperature:
-20°C up to +100°C (NBR)

Flow Rate Air:

310 l/min.
inlet pressure 6 bar, pressure drop 0.5 bar

Flow Rate Water:

2.7 l/min.
pressure drop 0.5 bar

* maximum static working pressure with design factor 4 to 1.

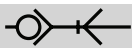

Single Shut-Off

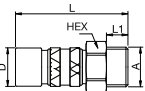
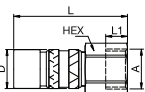
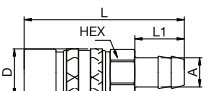
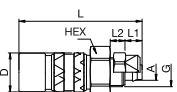

Nickel-plated brass

Connection A	HEX	L	L1	L2	D	G	Color Coding				
							0 Part Number	3 Part Number	6 Part Number	8 Part Number	
 21KAAW Coupler with valve, Male Thread	G1/8	14	47	7	16		21KAAW10MPN0	21KAAW10MPN3	21KAAW10MPN6	21KAAW10MPN8	
	G1/4	17	47	9	16		21KAAW13MPN0	21KAAW13MPN3	21KAAW13MPN6	21KAAW13MPN8	
 21KAIW Coupler with valve, Female Thread	G1/8	14	47	7	16		21KAIW10MPN0	21KAIW10MPN3	21KAIW10MPN6	21KAIW10MPN8	
	G1/4	17	47	9	16		21KAIW13MPN0	21KAIW13MPN3	21KAIW13MPN6	21KAIW13MPN8	
 21KATF Coupler with valve, Hose Barb	4	14	69	17	16		21KATF04MPN0	21KATF04MPN3	21KATF04MPN6	21KATF04MPN8	
	6	14	69	17	16		21KATF06MPN0	21KATF06MPN3	21KATF06MPN6	21KATF06MPN8	
 21KAKO Coupler with valve, with Plastic Hose Connection	4 x 6	14	51	7	6	16	M10x1	21KAKO06MPN0	21KAKO06MPN3	21KAKO06MPN6	21KAKO06MPN8
	6 x 8	14	51	7	6	16	M10x1	21KAKO08MPN0	21KAKO08MPN3	21KAKO08MPN6	21KAKO08MPN8

Series 21 - Coded Systems

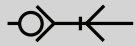

Single Shut-Off



Nickel-plated brass

Connection A	HEX	L	L1	L2	D	G					
							0	3	6	8	
							Part Number	Part Number	Part Number	Part Number	
 21SFAW Plug without valve, Male Thread	G1/8	17	39.5	7			21SFAW10MXN0	21SFAW10MXN3	21SFAW10MXN6	21SFAW10MXN8	
	G1/4	17	41.5	9			21SFAW13MXN0	21SFAW13MXN3	21SFAW13MXN6	21SFAW13MXN8	
 21SFIW Plug without valve, Female Thread	G1/8	17	38.5	7			21SFIW10MXN0	21SFIW10MXN3	21SFIW10MXN6	21SFIW10MXN8	
	G1/4	17	39	9			21SFIW13MXN0	21SFIW13MXN3	21SFIW13MXN6	21SFIW13MXN8	
 21SFTF Plug without valve, Hose Barb	4		47	17		15	21SFTF04MXN0	21SFTF04MXN3	21SFTF04MXN6	21SFTF04MXN8	
	6		47	17		15	21SFTF06MXN0	21SFTF06MXN3	21SFTF06MXN6	21SFTF06MXN8	
 21SFKO Plug without valve, with Plastic Hose Connection	4 x 6		43	7	6	15	M10x1	21SFKO06MXN0	21SFKO06MXN3	21SFKO06MXN6	21SFKO06MXN8
	6 x 8		43.5	7	6	15	M12x1	21SFKO08MXN0	21SFKO08MXN3	21SFKO08MXN6	21SFKO08MXN8

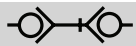

Double Shut-off



Nickel-plated brass

Connection A	HEX	L	L1	L2	D	G					
							0	3	6	8	
							Part Number	Part Number	Part Number	Part Number	
 21KBAW Coupler with valve, Male Thread	G1/8	14	47	7		16	21KBAW10MPN0	21KBAW10MPN3	21KBAW10MPN6	21KBAW10MPN8	
	G1/4	17	47	9		16	21KBAW13MPN0	21KBAW13MPN3	21KBAW13MPN6	21KBAW13MPN8	
 21KBIW Coupler with valve, Female Thread	G1/8	14	47	7		16	21KBIW10MPN0	21KBIW10MPN3	21KBIW10MPN6	21KBIW10MPN8	
	G1/4	17	47	9		16	21KBIW13MPN0	21KBIW13MPN3	21KBIW13MPN6	21KBIW13MPN8	
 21KBTF Coupler with valve, Hose Barb	4	14	69	17		16	21KBTF04MPN0	21KBTF04MPN3	21KBTF04MPN6	21KBTF04MPN8	
	6	14	69	17		16	21KBTF06MPN0	21KBTF06MPN3	21KBTF06MPN6	21KBTF06MPN8	
 21KBKO Coupler with valve, with Plastic Hose Connection	4 x 6	14	51	7	6	16	M10x1	21KBKO06MPN0	21KBKO06MPN3	21KBKO06MPN6	21KBKO06MPN8
	6 x 8	14	51	7	6	16	M10x1	21KBKO08MPN0	21KBKO08MPN3	21KBKO08MPN6	21KBKO08MPN8

Series 21 - Coded Systems

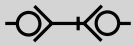

Double Shut-off



Nickel-plated brass

Connection A	HEX	L	L1	L2	D	G				
							0	3	6	8
							Part Number	Part Number	Part Number	Part Number
 21SBAW Plug with valve, Male Thread	G1/8	14	48	7			21SBAW10MPN0	21SBAW10MPN3	21SBAW10MPN6	21SBAW10MPN8
	G1/4	17	50	9			21SBAW13MPN0	21SBAW13MPN3	21SBAW13MPN6	21SBAW13MPN8
 21SBIW Plug with valve, Female Thread	G1/8	14	48	7			21SBIW10MPN0	21SBIW10MPN3	21SBIW10MPN6	21SBIW10MPN8
	G1/4	17	50	9			21SBIW13MPN0	21SBIW13MPN3	21SBIW13MPN6	21SBIW13MPN8
 21SBTF Plug with valve, Hose Barb	4	14	58	17			21SBTF04MPN0	21SBTF04MPN3	21SBTF04MPN6	21SBTF04MPN8
	6	14	58	17			21SBTF06MPN0	21SBTF06MPN3	21SBTF06MPN6	21SBTF06MPN8
 21SBKO Plug with valve, with Plastic Hose Connection	4 x 6	14	54	7	6	M10x1	21SBKO06MPN0	21SBKO06MPN3	21SBKO06MPN6	21SBKO06MPN8
	6 x 8	14	54	7	6	M12x1	21SBKO08MPN0	21SBKO08MPN3	21SBKO08MPN6	21SBKO08MPN8



Coded industrial coupling system developed on the basis of series 25. Coupling system with single-hand operation. High Flow valve for optimum flow and low pressure drop. The mechanical coding of the coupling and plug offers a guarantee for avoiding mix-ups between media when coupling, which is complemented by the color coding of the anodised sleeves. Double shut-off and straightthrough couplings are available upon request. Cannot be interconnected with the Rectus standard 25 series.

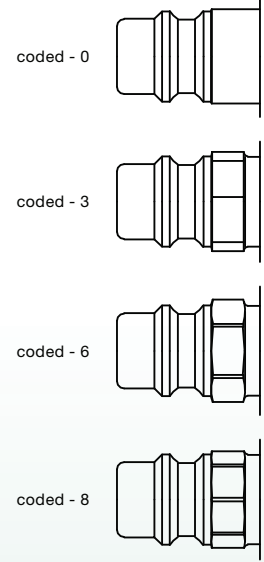

KA Single Shut-Off

Working Pressure*:
up to 12 bar

Material:

- **Coupling:** Brass or nickel plated brass
- **Plug:** Nickel plated brass
- **Seals:** NBR

Working Temperature:
-20°C up to +100°C (NBR)

Flow Rate Air:
1.800 l/min.
inlet pressure 6 bar, pressure drop 0.5 bar

Flow Rate Water:
28 l/min.
pressure drop 0.5 bar

KB Double Shut-Off

Working Pressure*:
up to 35 bar

Material:

- **Coupling:** Nickel plated brass / steel
- **Plug:** Nickel plated brass
- **Seals:** NBR

Working Temperature:
-20°C up to +100°C (NBR)

Flow Rate Air:
710 l/min.
inlet pressure 6 bar, pressure drop 0.5 bar

Flow Rate Water:
7.1 l/min.
pressure drop 0.5 bar

* maximum static working pressure with design factor 4 to 1.

Series 25 - Coded Systems

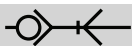

Single Shut-Off

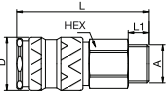
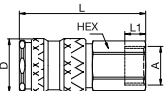
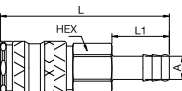

Nickel-plated brass

Connection A	HEX	L	L1	L2	D	G	0	3	6	8
							Part Number	Part Number	Part Number	Part Number
 25KAAW Coupler with valve, Male Thread	G1/4	19	60	9		23	25KAAW13BPN0	25KAAW13BPN3	25KAAW13BPN6	25KAAW13BPN8
	G3/8	19	58	9		23	25KAAW17BPN0	25KAAW17BPN3	25KAAW17BPN6	25KAAW17BPN8
	G1/2	22	61	12		23	25KAAW21BPN0	25KAAW21BPN3	25KAAW21BPN6	25KAAW21BPN8
 25KAIW Coupler with valve, Female Thread	G1/4	19	56	10		23	25KAIW13BPN0	25KAIW13BPN3	25KAIW13BPN6	25KAIW13BPN8
	G3/8	19	55	9		23	25KAIW17BPN0	25KAIW17BPN3	25KAIW17BPN6	25KAIW17BPN8
	G1/2	24	58	12		23	25KAIW21BPN0	25KAIW21BPN3	25KAIW21BPN6	25KAIW21BPN8
 25KATF Coupler with valve, Hose Barb	6	19	74	25		23	25KATF06BPN0	25KATF06BPN3	25KATF06BPN6	25KATF06BPN8
	9	19	74	25		23	25KATF09BPN0	25KATF09BPN3	25KATF09BPN6	25KATF09BPN8
	13	19	74	25		23	25KATF13BPN0	25KATF13BPN3	25KATF13BPN6	25KATF13BPN8

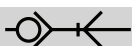

Single Shut-Off

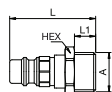
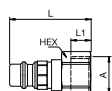
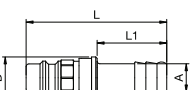

Nickel-plated brass

Connection A	HEX	L	L1	L2	D	G	0	3	6	8
							Part Number	Part Number	Part Number	Part Number
 26SFAW Plug without valve, Male Thread	G1/4	17	36.5	9			26SFAW13MXN0	26SFAW13MXN3	26SFAW13MXN6	26SFAW13MXN8
	G3/8	19	36.5	9			26SFAW17MXN0	26SFAW17MXN3	26SFAW17MXN6	26SFAW17MXN8
 26SFIW Plug without valve, Female Thread	G1/4	17	36.5	10			26SFIW13MXN0	26SFIW13MXN3	26SFIW13MXN6	26SFIW13MXN8
	G3/8	19	36.5	10			26SFIW17MXN0	26SFIW17MXN3	26SFIW17MXN6	26SFIW17MXN8
 26SFTF Plug without valve, Hose Barb	6		50.5	25		15	26SFTF06MXN0	26SFTF06MXN3	26SFTF06MXN6	26SFTF06MXN8
	9		50.5	25		15	26SFTF09MXN0	26SFTF09MXN3	26SFTF09MXN6	26SFTF09MXN8

Series 25 - Coded Systems

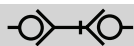

Double Shut-off



Nickel-plated brass

Connection A	HEX	L	L1	L2	D	G				
							0	3	6	8
							Part Number	Part Number	Part Number	Part Number
 25KBAW Coupler with valve, Male Thread	G1/4	19	60	9	23		25KBAW13BPNO	25KBAW13BPN3	25KBAW13BPN6	25KBAW13BPN8
	G3/8	19	58	9	23		25KBAW17BPNO	25KBAW17BPN3	25KBAW17BPN6	25KBAW17BPN8
	G1/2	22	61	12	23		25KBAW21BPNO	25KBAW21BPN3	25KBAW21BPN6	25KBAW21BPN8
 25KBIW Coupler with valve, Female Thread	G1/4	19	56	10	23		25KBIW13BPNO	25KBIW13BPN3	25KBIW13BPN6	25KBIW13BPN8
	G3/8	19	55	9	23		25KBIW17BPNO	25KBIW17BPN3	25KBIW17BPN6	25KBIW17BPN8
	G1/2	24	58	12	23		25KBIW21BPNO	25KBIW21BPN3	25KBIW21BPN6	25KBIW21BPN8
 25KBTF Coupler with valve, Hose Barb	6	19	74	25	23		25KBTF06BPNO	25KBTF06BPN3	25KBTF06BPN6	25KBTF06BPN8
	9	19	74	25	23		25KBTF09BPNO	25KBTF09BPN3	25KBTF09BPN6	25KBTF09BPN8
	13	19	74	25	23		25KBTF13BPNO	25KBTF13BPN3	25KBTF13BPN6	25KBTF13BPN8

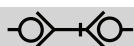

Double Shut-off



Nickel-plated brass

Connection A	HEX	L	L1	L2	D	G				
							0	3	6	8
							Part Number	Part Number	Part Number	Part Number
 25SBAW Plug with valve, Male Thread	G1/4	22	44.5	9			25SBAW13MPNO	25SBAW13MPN3	25SBAW13MPN6	25SBAW13MPN8
	G3/8	22	44.5	9			25SBAW17MPNO	25SBAW17MPN3	25SBAW17MPN6	25SBAW17MPN8
 25SBIW Plug with valve, Female Thread	G1/4	22	44.5	10			25SBIW13MPNO	25SBIW13MPN3	25SBIW13MPN6	25SBIW13MPN8
	G3/8	22	44.5	9			25SBIW17MPNO	25SBIW17MPN3	25SBIW17MPN6	25SBIW17MPN8
 25SBTF Plug with valve, Hose Barb	6	21	61.5	25			25SBTF06MPNO	25SBTF06MPN3	25SBTF06MPN6	25SBTF06MPN8
	9	21	61.5	25			25SBTF09MPNO	25SBTF09MPN3	25SBTF09MPN6	25SBTF09MPN8

DN Male x Male Nipple

Brass or stainless steel



A	Version	HEX	L	Version
G1/8 x G1/8 *	DN10/10	14	19	Brass
G1/8 x G1/4 *	DN10/13	17	19.5	Brass
G1/8 x G3/8 **	DN10/17	19	21	Brass
G1/4 x G1/4 *	DN13/13	17	22	Brass
G1/4 x G1/4 *	DN13/13R	17	22	AISI 303
R1/4 x R1/4 con.	DN13/13K	14	30	Brass
G1/4 x G3/8 **	DN13/17	19	22.5	Brass
G1/4 x G3/8 **	DN13/17R	19	22.5	AISI 303
G1/4 x G3/8 ext. **	DN13/17V	19	24.5	Brass
G1/4 x G1/2 *	DN13/21	24	25.5	Brass
G3/8 x G3/8 **	DN17/17	19	23	Brass
G3/8 x G3/8 **	DN17/17R	19	23	AISI 303
G3/8 x G3/8 ext. **	DN17/17V	19	27	Brass
R3/8 x R3/8 con.	DN17/17K	17	30	Brass
G3/8 x G1/2 **	DN17/21	24	26	Brass
G3/8 x G1/2 **	DN17/21R	24	26	AISI 303
G3/8 x G3/4 **	DN17/26	32	29.5	Brass
G1/2 x G1/2 *	DN21/21	24	28	Brass
G1/2 x G1/2 *	DN21/21R	24	28	AISI 303
R1/2 x R1/2 con.	DN21/21K	22	34	Brass
G1/2 x G3/4 *	DN21/26	32	31.5	Brass
G1/2 x G1 *	DN21/33	36	36.5	Brass
G3/4 x G3/4 *	DN26/26	32	33	Brass
G3/4 x G1 *	DN26/33	36	34	Brass
G1 x G1 *	DN33/33	36	37	Brass

* Inner Cone 45°

** Inner Cone 45°, useable only together with Threaded Nut UR17S

LD Male x Male Nipple adjustable

Brass

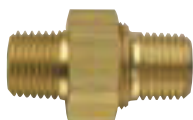

A	Version	HEX	L
R1/8 x R1/8	LD10/10K	15	27
R1/4 x R1/4	LD13/13K	19	34
R3/8 x R3/8	LD17/17K	22	37
R1/2 x R1/2	LD21/21K	27	44.5
R3/4 x R3/4	LD26/26K	36	53
R1 x R1	LD33/33K	46	64

RK Reducing Bush, short

Brass



Version	HEX	L
RK05/10	14	11
RK05/13	17	12.5
RK10/13	17	12.5
RK10/17	19	13
RK10/21	24	17
RK13/17	19	14
RK13/21	24	17
RK17/21	24	17
RK17/26	32	18
RK21/26	32	20.5
RK21/33	36	21.5
RK26/33	36	21.5

C1: Male Thread C2: Female Thread

RL Reducing Bush, long

Brass



Version	HEX	L
RL05/05	8	15
RL05/10	14	17
RL10/10*	14	23
RL10/13*	17	26
RL13/10*	17	26
RL13/13*	17	28
RL13/17*	19	29
RL17/13*	19	29
RL17/17*	19	29
RL17/21*	24	32
RL21/17*	24	34
RL21/21*	24	34
RL21/26*	32	31

* Inner Cone 45°

C1: Male Thread C2: Female Thread

MU Female x Female Socket

Brass



A	Version	HEX	L
M5	MU05	8	12
G1/8	MU10	14	22
G1/4	MU13	17	26
G3/8	MU17	22	26
G1/2	MU21	27	30
G3/4	MU26	32	36
G1	MU33	41	40

WS 90° Elbow

Brass

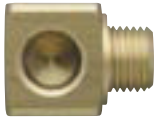

A		L
G1/8	WS10	16
G1/4	WS13	22
G3/8	WS17	27

FD Washer, Fiber

Fiber



A		L
for M5	FD05	
for G1/8	FD10	
for G1/4	FD13	
for G3/8	FD17	
for G1/2	FD21	
for G3/4	FD26	

KM Bulkhead Lock Nut

Brass



A		HEX
G1/8	KM10W	15
G1/4	KM13W	17
G3/8	KM17W	22
G1/2	KM21W	27
G3/4	KM26W	30

AD Washer, Aluminium

Aluminium



A		L
for G1/8	AD10	
for G1/4	AD13	
for G3/8	AD17	
for G1/2	AD21	
for G3/4	AD26	

VZ Blanking Plug - Socket Pipe (DIN 908)

Brass



A		HEX	L
M5 (head pipe)	VZ05	8	8
G1/8	VZ10	5	11
G1/4	VZ13	6	15
G3/8	VZ17	8	15
G1/2	VZ21	10	18
G3/4	VZ26	12	20

TI Female Tee

Brass



A		L
G1/8	TI10	34
G1/4	TI13	38.5
G3/8	TI17	44
G1/2	TI21	44
G3/4	TI26	50
G1	TI33	64.5

PD Washer, PVC

PVC



A		L
for M5	PD05	
for G1/8	PD10	
for G1/4	PD13	
for G3/8	PD17	
for G1/2	PD21	
for G3/4	PD26	

WI Male Elbow

Brass



A		L
G1/8	WI10	25
G1/4	WI13	29
G3/8	WI17	35
G1/2	WI21	40
G3/4	WI26	47
G1	WI33	55

with Inner Cone

YA Female Y with one Male Thread

Brass



A



HEX

R1/8 o. / G1/8 i.	YA10	13
R1/4 o., G1/4 i.	YA13	17
R3/8 o., G3/8 i.	YA17	20
R1/2 o., G1/2 i.	YA21	25

2x Female Thread / 1x Male Thread con.

YI Female Y

Brass



A



HEX

G1/8	YI10	13
G1/4	YI13	17
G3/8	YI17	20
G1/2	YI21	25

3x Female Thread

ZO 2 Way Manifold

Brass



A



L

G3/8 i.	Z017	47
G1/2 i.	Z021	55

DO 3 Way Manifold

Brass



A



L

G3/8 i.	D017	61
G1/2 i.	D021	67

WD Manifold

Aluminium elox.

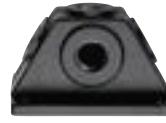

A



G3/8 i.	WD17
G1/2 i.	WD21

FA Swivel Joint

Nickel-plated steel



A



HEX L

G1/4 i. x G1/4 o.	FA13A13ISPN	17	52
G3/8 i. x G3/8 o.	FA17A17ISPN	21	58

SK Dust Protection for coupling and plug

Thermo Flex or Euro Flex



	Material	Version	Flame Resistance	Temperature Range	Color
SK12S	Thermo Flex	universal	UL-VO	-25 up to 120°C	BLUE
SK16S	Euro Flex	universal	UL-VO	-25 up to 120°C	RED
SK23S	Thermo Flex	universal	UL-VO	-25 up to 120°C	BLUE
SK27S	Thermo Flex	universal	UL-VO	-25 up to 120°C	BLUE



The 86, 87 and 88 Rectus Moldtite coupling series were especially developed for connecting coolant lines and injection moulds. Countersunk plugs can easily be connected and disconnected because of the extended sleeve. The angular connections prevent kinks from forming in the hose.

- Available in:
 - single shut-off, double shut-off or straight-through versions
- The shut-off couplings (with valve) are equipped with nickel plated sleeves for quick and accurate visual differentiation

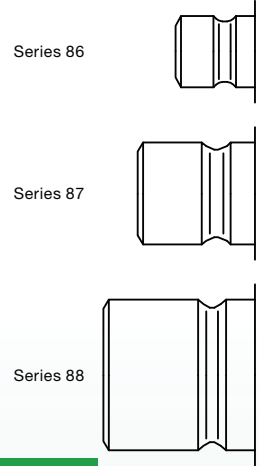

KF Straight-Through

Working Pressure*:
up to 15 bar

Material:

- Coupling: Brass
- Plug: Brass
- Seals: FKM

Working Temperature:
-15°C up to +200°C (FKM)

Flow Rate Water:

- Series 86: 17 l/min.
- Series 87: 29 l/min.
- Series 88: 94 l/min.

pressure drop 0.5 bar

KA Single Shut-Off

Working Pressure*:
up to 15 bar

Material:

- Coupling: Brass
- Plug: Brass
- Seals: FKM

Working Temperature:
-15°C up to +200°C (FKM)

Flow Rate Water:

- Series 86: 9 l/min.
- Series 87: 16 l/min.
- Series 88: 55 l/min.

pressure drop 0.5 bar

KB Double Shut-Off

Working Pressure*:
up to 15 bar

Material:

- Coupling: Brass
- Plug: Brass
- Seals: FKM

Working Temperature:
-15°C up to +200°C (FKM)

Flow Rate Water:

- Series 86: 8 l/min.
- Series 87: 15 l/min.

pressure drop 0.5 bar

* maximum static working pressure with design factor 4 to 1.

→|← Straight-Through

86/87/88KFAW Coupler without valve, Male Thread

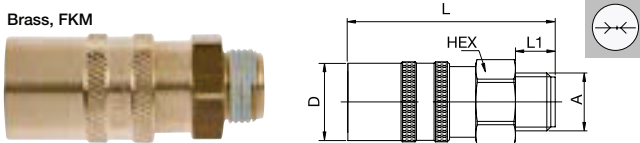

DN	Series	A	HEX	L	L1	D
6	86	G1/4	86KFAW13MVX	17	47	9 18
		G3/8	86KFAW17MVX	19	47	9 18
9	87	G1/4	87KFAW13MVX	22	56.5	9 24
		G3/8	87KFAW17MVX	22	56.5	9 24
		G1/2	87KFAW21MVX	22	59.5	12 24
13	88	G1/2	88KFAW21MVX	30	73	12 32

→|← Straight-Through

86/87/88KFIW Coupler without valve, Female Thread

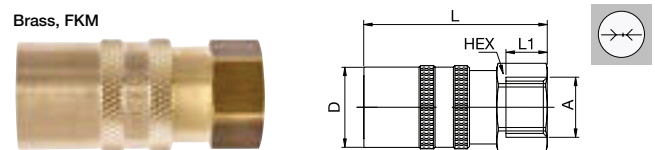

DN	Series	A	HEX	L	L1	D
6	86	G1/8	86KFIW10MVX	17	40	12 18
		G1/4	86KFIW13MVX	17	40	12 18
9	87	G1/4	87KFIW13MVX	21	51.5	10 24
		G3/8	87KFIW17MVX	21	51.5	10 24
13	88	G1/2	88KFIW21MVX	30	68	12 32



Straight-Through

86/87/88KFTF Coupler without valve, Hose Barb

Brass, FKM

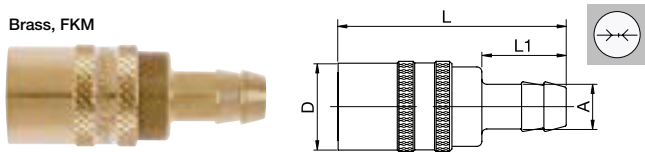

DN	Series	A		L	L1	D
6	86	6	86KFTF06MVX	46	17	18
		9	86KFTF09MVX	46	22	18
9	87	9	87KFTF09MVX	64	22	24
		13	87KFTF13MVX	66.5	25	24
13	88	19	88KFTF19MVX	89	32	32



Straight-Through

86/87KFTP Coupler without valve, Push-Lok

Brass, FKM

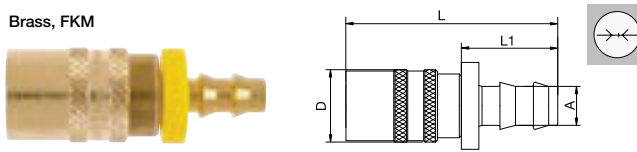

DN	Series	A		L	L1	D
6	86	6	86KFTP06MVX	49	20.4	18
		10	86KFTP10MVX	53	24.2	18
9	87	10	87KFTP10MVX	65.5	24.2	24
		13	87KFTP13MVX	69.5	27.9	24

86/87/88KFTR Coupler without valve, Hose Barb 90°

Brass, FKM

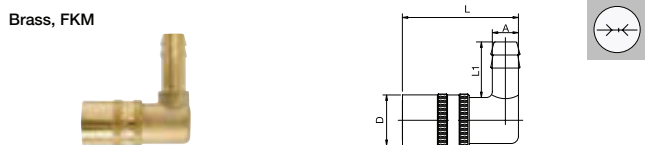

DN	Series	A		L	L1	D
6	86	6	86KFTR06MVX	40	17	18
		9	86KFTR09MVX	40	22	18
9	87	9	87KFTR09MVX	56	22	24
		13	87KFTR13MVX	56	28.5	24
13	88	19	88KFTR19MVX	77	32	32

86/87KFPR Coupler without valve, Push-Lok 90°

Brass, FKM

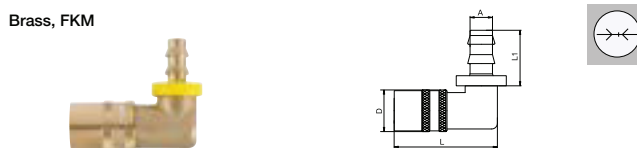

DN	Series	A		L	L1	D
6	86	6	86KFPR06MVX	45	20.4	18
		10	86KFPR10MVX	45	24.2	18
9	87	10	87KFPR10MVX	61.5	24.2	24
		13	87KFPR13MVX	61.5	27.9	24

86/87KFTH Coupler without valve, Hose Barb 45°

Brass, FKM

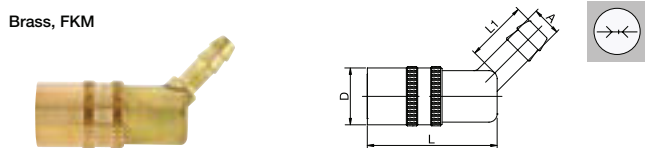

DN	Series	A		L	L1	D
6	86	6	86KFTH06MVX	40	17	18
		9	86KFTH09MVX	40	22	18
9	87	9	87KFTH09MVX	56	22	24
		13	87KFTH13MVX	56	25	24

86/87KFPH Coupler without valve, Push-Lok 45°

Brass, FKM

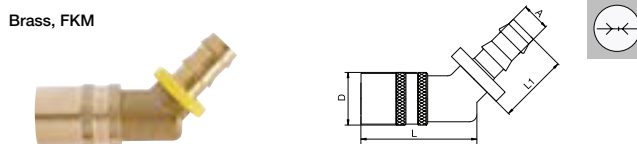

DN	Series	A		L	L1	D
6	86	6	86KFPH06MVX	40	20.4	18
		10	86KFPH10MVX	40	24.2	18
9	87	10	87KFPH10MVX	56	24.2	24
		13	87KFPH13MVX	56	27.9	24



Single Shut-off / Double shut-off

86/87/88KBAW Coupler with valve, Male Thread

Brass, FKM

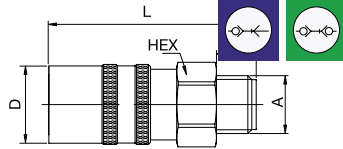

DN	Series	A		HEX	L	L1	D
6	86	G1/4	86KBAW13MVX	17	47	9	18
		G3/8	86KBAW17MVX	19	47	9	18
9	87	G1/4	87KBAW13MVX	22	56.5	9	24
		G3/8	87KBAW17MVX	22	56.5	9	24
		G1/2	87KBAW21MVX	22	59.5	12	24
13	88	G1/2	88KAAW21MVX	30	73	12	32

86/87/88KBIW Coupler with valve, Female Thread

Brass, FKM

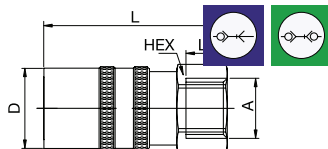

DN	Series	A		HEX	L	L1	D
6	86	G1/8	86KBIW10MVX	17	40	12	18
		G1/4	86KBIW13MVX	17	40	12	18
9	87	G1/4	87KBIW13MVX	21	51.5	10	24
		G3/8	87KBIW17MVX	21	51.5	10	24
13	88	G1/2	88KAIW21MVX	30	68	12	32

86/87/88KBTf Coupler with valve, Hose Barb

Brass, FKM

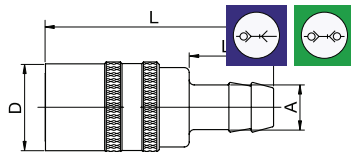

DN	Series	A		L	L1	D
6	86	6	86KBTf06MVX	46	17	18
		9	86KBTf09MVX	46	22	18
9	87	9	87KBTf09MVX	64	22	24
		13	87KBTf13MVX	66.5	25	24
13	88	19	88KATf19MVX	89	32	32



Single Shut-off / Double shut-off

86/87/88KBTR Coupler with valve, Hose Barb 90°

Brass, FKM

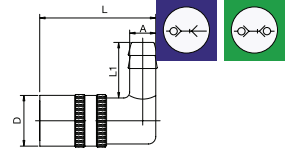

DN	Series	A		L	L1	D
6	86	6	86KBTR06MVX	40	17	18
		9	86KBTR09MVX	40	22	18
9	87	9	87KBTR09MVX	56	22	24
		13	87KBTR13MVX	56	28.5	24
13	88	19	88KATR19MVX	77	32	32

86/87KBTH Coupler with valve, Hose Barb 45°

Brass, FKM

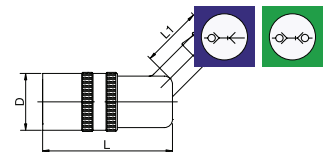

DN	Series	A		L	L1	D
6	86	6	86KBTH06MVX	40	17	18
		9	86KBTH09MVX	40	22	18
9	87	9	87KBTH09MVX	56	22	24
		13	87KBTH13MVX	56	25	24

86/87KBTP Coupler with valve, Push-Lok

Brass, FKM

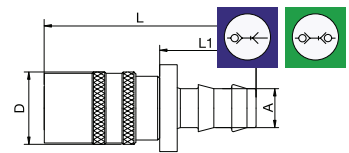

DN	Series	A		L	L1	D
6	86	6	86KBTP06MVX	49	20.4	18
		10	86KBTP10MVX	53	24.2	18
9	87	10	87KBTP10MVX	65.5	24.2	24
		13	87KBTP13MVX	69.5	27.9	24



Single Shut-off / Double shutt-off

86/87KBPR Coupler with valve, Push-Lok 90°

Brass, FKM

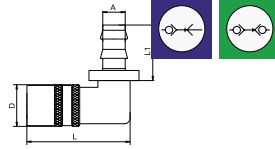

DN	Series	A		L	L1	D
6	86	6	86KBPR06MVX	45	20.4	18
		10	86KBPR10MVX	45	24.2	18
9	87	10	87KBPR10MVX	61.5	24.2	24
		13	87KBPR13MVX	61.5	27.9	24

86/87KBPH Coupler with valve, Push-Lok 45°

Brass, FKM

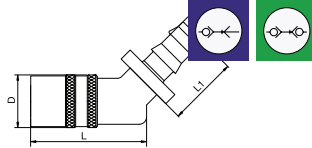

DN	Series	A		L	L1	D
6	86	6	86KBPH06MVX	40	20.4	18
		10	86KBPH10MVX	40	24.2	18
9	87	10	87KBPH10MVX	56	24.2	24
		13	87KBPH13MVX	56	27.9	24



Straight-Through / Single Shut-off

86/87/88SFA Plug without valve, Male Thread

Brass

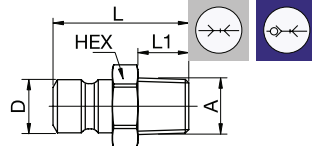

DN	Series	A		HEX	L	L1	D
6	86	M10 x 1	86SFAM10MXX	13	23	8	9.5
		R1/8	86SFAK10MXX	13	24	9	9.5
		R1/4	86SFAK13MXX	16	29	12	9.5
		R3/8	86SFAK17MXX	19	30	12	9.5
9	87	R1/4	87SFAK13MXX	16	34	12	13.5
		R3/8	87SFAK17MXX	19	34	12	13.5
13	88	R1/2	87SFAK21MXX	24	39	17	13.5
		R1/2	88SFAK21MXX	22	44	17	20
		R3/4	88SFAK26MXX	29	45	19	20



Straight-Through / Single Shut-off

86/87SFAR Plug without valve, Male Thread 90° tapered

Brass

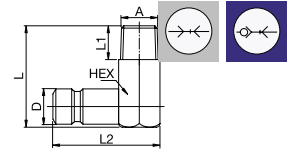

DN	Series	A		HEX	L	L1	L2	D
6	86	R1/8	86SFAR10MXX	11	27	9	28.5	9.5
		R1/4	86SFAR13MXX	14	27	9	32	9.5
9	87	R1/4	87SFAR13MXX	15	34	9	32	13.5
		R3/8	87SFAR17MXX	19	37	12	36	13.5

86/87SFIW Plug without valve, Female Thread

Brass

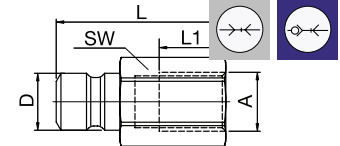

DN	Series	A		HEX	L	L1	D
6	86	G1/8	86SFIW10MXX	13	28	11	9.5
		G1/4	86SFIW13MXX	16	32	13	9.5
9	87	G1/4	87SFIW13MXX	16	37	13	13.5
		G3/8	87SFIW17MXX	19	39	16	13.5

86/87SFTF Plug without valve, Hose Barb

Brass

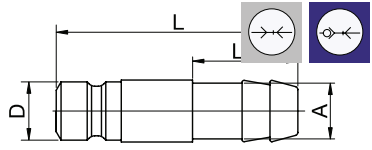

DN	Series	A		L	L1	D
6	86	9	86SFTF09MXX	39	22	9.5
9	87	13	87SFTF13MXX	41	21	13.5

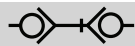

Double Shut-off

86/87SBAK Plug with valve, Male Thread

Brass, FKM

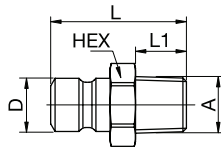
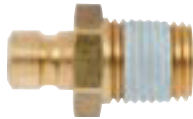

DN	Series	A		HEX	L	L1	D
6	86	R1/4	86SBAK13MVX	6	29	14	9.5
9	87	R1/4	87SBAK13MVX	16	34	12	13.5
		R3/8	87SBAK17MVX	19	34	12	13.5



Straight-Through

86/87VN Extension Plug, Male Thread

Brass



DN	Series	A		HEX	L	L1	D
6	86	R1/8	86VN1010MXX	11	100	9	9.5
		R1/8	86VN1015MXXS_01	11	150	9	9.5
		R1/8	86VN1025MXX	11	250	9	9.5
9	87	R1/4	87VN1315MXX	15	150	12	13.5
		R1/4	87VN1325MXX	15	250	12	13.5
6	86	G1/8	86VN1010MXXS_01	11	100	60	9.5
		G1/4	86VN1310MXX	14	100	60	9.5
9	87	G1/4	87VN1310MXX	14	100	60	13.5
		G3/8	87VN1710MXX	17	100	60	13.5



The 86 and 87 Rectus Moldtite coupling series with Safe-Lock technology were especially developed for connecting coolant lines and injection moulds. Countersunk plugs can easily be connected and disconnected because of the extended sleeve. The angular connections prevent kinks from forming in the hose.

- Available in single shut-off, double shut-off or straight-through versions
- The shut-off couplings (with valve) are equipped with nickel plated sleeves for quick and accurate visual differentiation

Series 86



Series 87

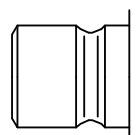

KF Straight-Through

Working Pressure*:
up to 15 bar

Material:

- Coupling: Brass
- Plug: Brass
- Seals: FKM

Working Temperature:
-15°C up to +200°C (FKM)

Flow Rate Water:

- Series 86: 17 l/min.
- Series 87: 29 l/min.

pressure drop 0.5 bar

KA Single Shut-Off

Working Pressure*:
up to 15 bar

Material:

- Coupling: Brass
- Plug: Brass
- Seals: FKM

Working Temperature:
-15°C up to +200°C (FKM)

Flow Rate Water:

- Series 86: 9 l/min.
- Series 87: 16 l/min.

pressure drop 0.5 bar

KB Double Shut-Off

Working Pressure*:
up to 15 bar

Material:

- Coupling: Brass
- Plug: Brass
- Seals: FKM

Working Temperature:
-15°C up to +200°C (FKM)

Flow Rate Water:

- Series 86: 8 l/min.
- Series 87: 15 l/min.

pressure drop 0.5 bar

* maximum static working pressure with design factor 4 to 1.



Straight-Through

86/87KFAW Coupler without valve, Male Thread, Safe-Lock

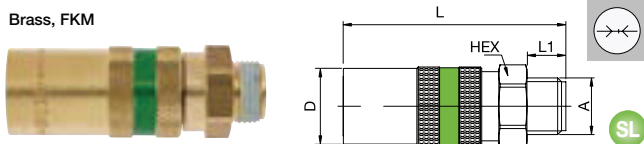

DN	Series	A	HEX	L	L1	D
6	86	G1/4	86KFAW13MVXSL	17	51.5	9 18
		G3/8	86KFAW17MVXSL	19	51.5	9 18
9	87	G1/4	87KFAW13MVXSL	22	67	9 24
		G3/8	87KFAW17MVXSL	22	67	9 24
		G1/2	87KFAW21MVXSL	22	70	12 24

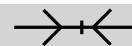

Straight-Through

86/87KFTR Coupler without valve, Hose Barb 90°, Safe-Lock

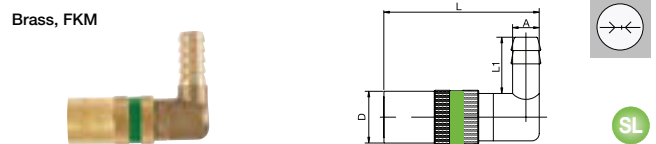

DN	Series	A	L	L1	D
6	86	9	86KFTR09MVXSL	52.5	22 18
		9	87KFTR09MVXSL	68.5	22 24
9	87	13	87KFTR13MVXSL	68.5	28.5 24

86/87KFTF Coupler without valve, Hose Barb, Safe-Lock

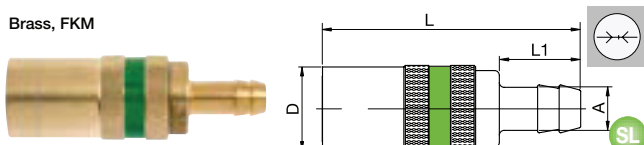

DN	Series	A	L	L1	D
6	86	9	86KFTF09MVXSL	59	22 18
		9	87KFTF09MVXSL	73	22 24
9	87	13	87KFTF13MVXSL	76	25 24

86/87KFTH Coupler without valve, Hose Barb 45°, Safe-Lock

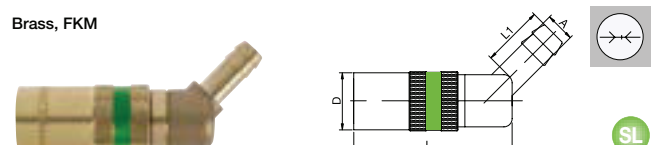

DN	Series	A	L	L1	D
6	86	9	86KFTH09MVXSL	51.5	22 18
		9	87KFTH09MVXSL	65.5	22 24
9	87	13	87KFTH13MVXSL	65.5	25 24

Series 86/87 - Safe Lock Technology



Single Shut-off / Double Shut-off

86/87KBAW Coupler with valve, Male Thread, Safe-Lock

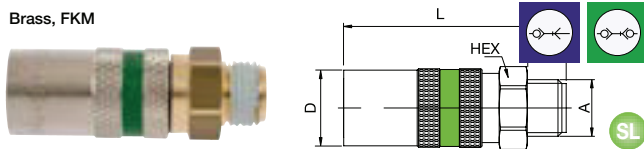

DN	Series	A		HEX	L	L1	D
6	86	G1/4	86KBAW13MVXSL	17	51.5	9	18
		G3/8	86KBAW17MVXSL	19	51.5	9	18
9	87	G1/4	87KBAW13MVXSL	22	67	9	24
		G3/8	87KBAW17MVXSL	22	67	9	24
		G1/2	87KBAW21MVXSL	22	70	12	24

86/87KBTF Coupler with valve, Hose Barb, Safe-Lock

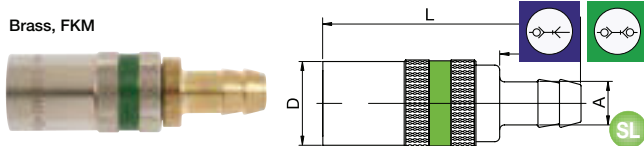

DN	Series	A		L	L1	D
6	86	9	86KBTF09MVXSL	59	22	18
9	87	9	87KBTF09MVXSL	73	22	24
		13	87KBTF13MVXSL	76	25	24

86/87KBTR Coupler with valve, Hose Barb 90°, Safe-Lock

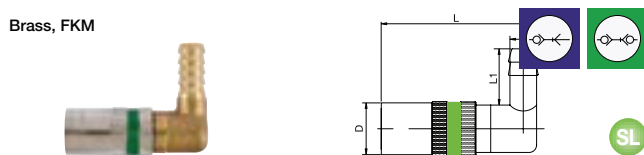

DN	Series	A		L	L1	D
6	86	9	86KBTR09MVXSL	52.5	22	18
9	87	9	87KBTR09MVXSL	68.5	22	24
		13	87KBTR13MVXSL	68.5	28.5	24

86/87KBTH Coupler with valve, Hose Barb 45°, Safe-Lock

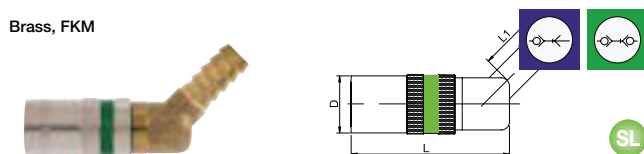

DN	Series	A		L	L1	D
6	86	9	86KBTH09MVXSL	51.5	22	18
9	87	9	87KBTH09MVXSL	65.5	22	24
		13	87KBTH13MVXSL	65.5	25	24



The 10, 11 and 12 Rectus Moldtite coupling series were especially developed for connecting coolant lines and injection moulds. These stand out for their convenient, single-handed operation and a reliable O-ring seal. Widely used in Europe.

- Available in:
 - single shut-off, double shut-off or straight-through versions
- The straight-through couplings are equipped with nickel plated sleeves for quick and accurate visual differentiation
- The angular connections prevent kinks from forming in the hose
- Available on request:
 - series 10/11 are also available with special FFKM high-temperature seal for applications up to constant temperature 200°C

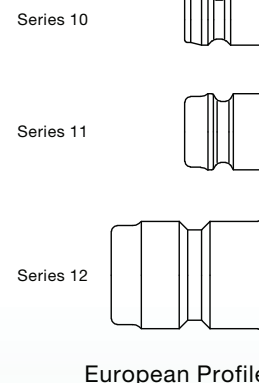

KF Straight-Through

Working Pressure*:
up to 15 bar

Material:

- Coupling: Brass
- Plug: Brass, stainless steel
- Seals: FKM

Working Temperature:
-15°C up to +200°C (FKM)

Flow Rate Water:

- Series 10: 16 l/min.
- Series 11: 50 l/min.
- Series 12: 106 l/min.

pressure drop 0.5 bar

KA Single Shut-Off

Working Pressure*:
up to 15 bar

Material:

- Coupling: Brass
- Plug: Brass, stainless steel
- Seals: FKM

Working Temperature:
-15°C up to +200°C (FKM)

Flow Rate Water:

- Series 10: 8 l/min.
- Series 11: 20 l/min.
- Series 12: 38 l/min.

pressure drop 0.5 bar

KB Double Shut-Off

Working Pressure*:
up to 15 bar

Material:

- Coupling: Brass
- Plug: Brass
- Seals: FKM

Working Temperature:
-15°C up to +200°C (FKM)

Flow Rate Water:

- Series 10: 7 l/min.
- Series 11: 15 l/min.
- Series 12: 28 l/min.

pressure drop 0.5 bar

* maximum static working pressure with design factor 4 to 1.

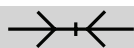

Straight-Through

10/11/12KFA Coupler without valve, Male Thread

Brass, FKM

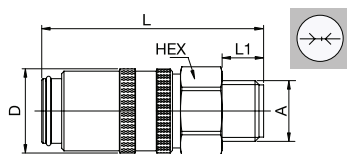

DN	Series	A	HEX	L	L1	D
6	10	M14 x 1.5 10KFAM14MVX	17	48	9	18
		G1/4 10KFAW13MVX	17	48	9	18
		G3/8 10KFAW17MVX	19	48	9	18
9	11	G1/4 11KFAW13MVX	22	51.5	9	23
		M16 x 1.5 11KFAM16MVX	22	51.5	9	23
		G3/8 11KFAW17MVX	22	51.5	9	23
13	12	G1/2 11KFAW21MVX	22	51.5	12	23
		G1/2 12KFAW21MVX	30	74	12	32
		G3/4 12KFAW26MVX	30	78	16	32



Straight-Through

10/11KFAR Coupler without valve, Male Thread 90°

Brass, FKM

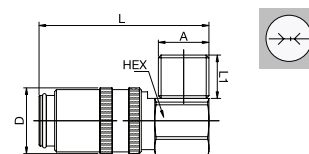

DN	Series	A	HEX	L	L1	D
6	10	G1/4 10KFAR13MVX	17	47	12	18
		M14 x 1.5 10KFAR14MVX	17	47	12	18
		M16 x 1.5 11KFAR16MVX	22	53.5	12	23

10/11KFAH Coupler without valve, Male Thread 45°

Brass, FKM

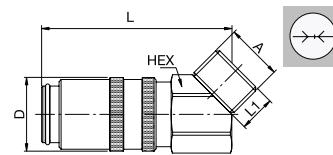

DN	Series	A	HEX	L	L1	D
6	10	G1/4 10KFAH13MVX	17	47	9	18
		M14 x 1.5 10KFAH14MVX	17	47	9	18
		M16 x 1.5 11KFAH16MVX	22	53.5	9	23



Straight-Through

10/11KFIW Coupler without valve, Female Thread

Brass, FKM

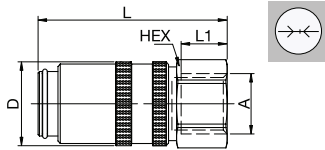

DN	Series	A		HEX	L	L1	D
6	10	G1/4	10KFIW13MVX	17	41	10	18
		G3/8	10KFIW17MVX	19	45	10	18
9	11	G1/4	11KFIW13MVX	21	46.5	10	23
		G3/8	11KFIW17MVX	21	46.5	10	23

10/11/12KFTF Coupler without valve, Hose Barb

Brass, FKM

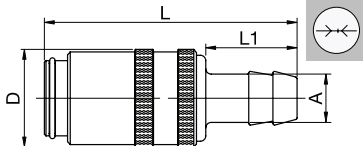
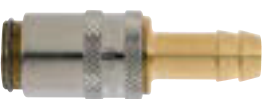

DN	Series	A		L	L1	D
6	10	9	10KFTF09MVX	52	22	18
9	11	13	11KFTF13MVX	61.5	25	23
13	12	19	12KFTF19MVX	90	32	32

10/11/12KFTR Coupler without valve, Hose Barb 90°

Brass, FKM

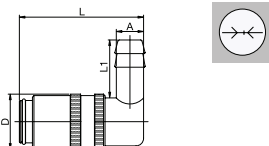

DN	Series	A		L	L1	D
6	10	9	10KFTR09MVX	41	22	18
9	11	13	11KFTR13MVX	51	28.5	23
13	12	19	12KFTR19MVX	78	32	32

10/11/12KFTH Coupler without valve, Hose Barb 45°

Brass, FKM

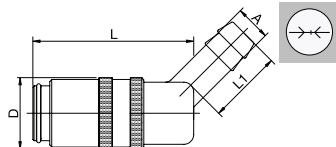

DN	Series	A		L	L1	D
6	10	9	10KFTH09MVX	52	22	18
9	11	13	11KFTH13MVX	51	25	23
13	12	19	12KFTH19MVX	78	30	32



Straight-Through

10/11KFTP Coupler without valve, Push-Lok

Brass, FKM

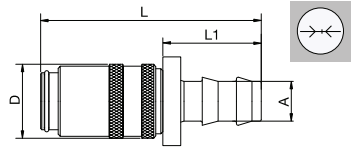

DN	Series	A		L	L1	D
6	10	6	10KFTP06MVX	50.5	20.4	18
		10	10KFTP10MVX	54	24.2	18
9	11	10	11KFTP10MVX	61	24.2	23
		13	11KFTP13MVX	64.5	27.9	23

10/11KFPR Coupler without valve, Push-Lok 90°

Brass, FKM

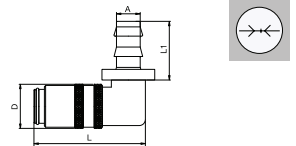

DN	Series	A		L	L1	D
6	10	6	10KFPR06MVX	46	20.4	18
		10	10KFPR10MVX	46	24.2	18
9	11	10	11KFPR10MVX	56.5	24.2	23
		13	11KFPR13MVX	56.5	27.9	23

10/11KFPH Coupler without valve, Push-Lok 45°

Brass, FKM

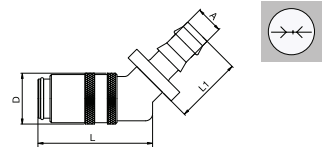

DN	Series	A		L	L1	D
6	10	6	10KFPH06MVX	41	20.4	18
		10	10KFPH10MVX	41	24.2	18
9	11	10	11KFPH10MVX	51	24.2	23
		13	11KFPH13MVX	51	27.9	23



Single Shut-off / Double Shut-off

10/11/12KBA Coupler with valve, Male Thread

Brass, FKM

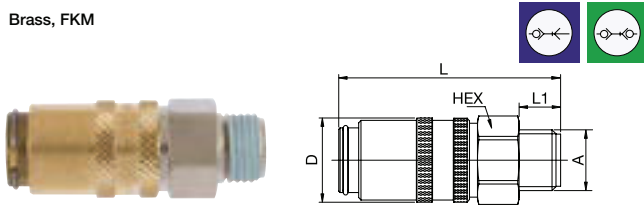

DN	Series	A	HEX	L	L1	D
6	10	M14 x 1.5 10KBAM14MVX	17	48	9	18
		G1/4 10KBAM13MVX	17	48	9	18
		G3/8 10KBAM17MVX	19	48	9	18
9	11	G1/4 11KBAM13MVX	22	51.5	9	23
		M16 x 1.5 11KBAM16MVX	22	51.5	9	23
		G3/8 11KBAM17MVX	22	51.5	9	23
13	12	G1/2 12KBAM21MVX	30	74	12	32
		G3/4 12KBAM26MVX	30	78	16	32

10/11KBAR Coupler with valve, Male Thread 90°

Brass, FKM

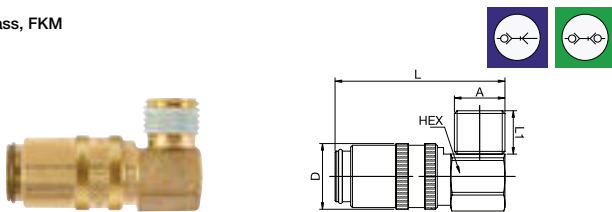

DN	Series	A	HEX	L	L1	D
6	10	G1/4 10KBAR13MVX	17	47	12	18
		M14 x 1.5 10KBAR14MVX	17	47	12	18
9	11	M16 x 1.5 11KBAR16MVX	22	53.5	12	23

10/11KBAH Coupler with valve, Male Thread 45°

Brass, FKM

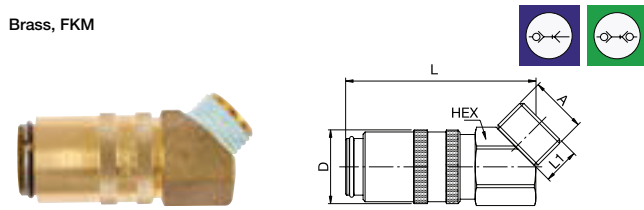

DN	Series	A	HEX	L	L1	D
6	10	G1/4 10KBAH13MVX	17	47	9	18
		M14 x 1.5 10KBAH14MVX	17	47	9	18
9	11	M16 x 1.5 11KBAH16MVX	22	53.5	9	23



Single Shut-off / Double Shut-off

10/11KBIW Coupler with valve, Female Thread

Brass, FKM

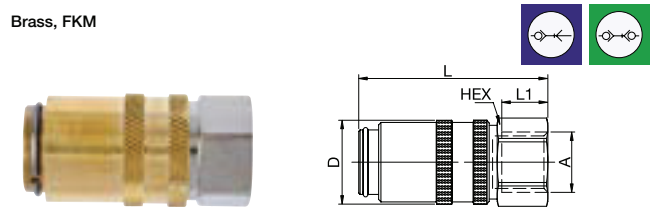

DN	Series	A	HEX	L	L1	D
6	10	G1/4 10KBIW13MVX	17	41	12	18
		G3/8 10KBIW17MVX	19	45	12	18
9	11	G1/4 11KBIW13MVX	21	46.5	10	23
		G3/8 11KBIW17MVX	21	46.5	10	23

10/11/12KBTf Coupler with valve, Hose Barb

Brass, FKM

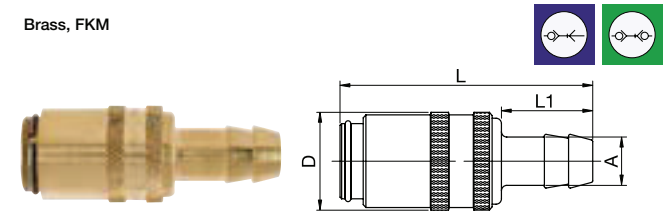

DN	Series	A	L	L1	D
6	10	9	52	22	18
9	11	13	61.5	25	23
13	12	19	90	32	32

10/11/12KBTR Coupler with valve, Hose Barb 90°

Brass, FKM

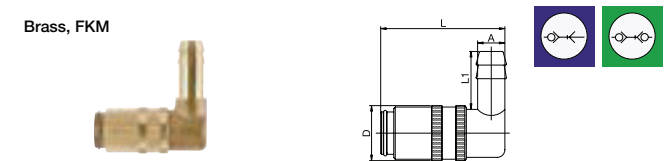

DN	Series	A	L	L1	D
6	10	9	41	22	18
9	11	13	51	28.5	23
13	12	19	78	32	32

10/11/12KBTH Coupler with valve, Hose Barb 45°

Brass, FKM

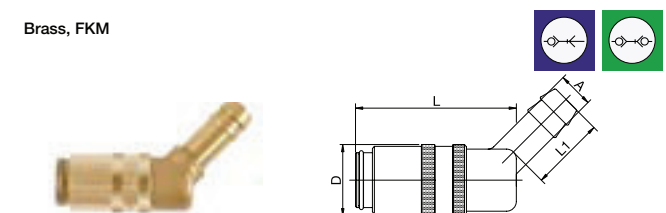

DN	Series	A	L	L1	D
6	10	9	52	22	18
9	11	13	51	25	23
13	12	19	78	30	32



Single Shut-off / Double Shut-off

10/11KBTP Coupler with valve, Push-Lok

Brass, FKM

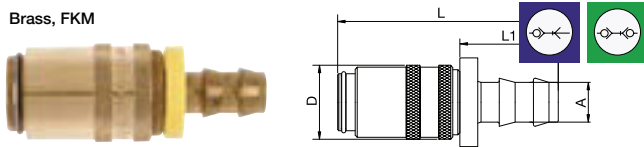

DN	Series	A		L	L1	D
6	10	6	10KBTP06MVX	50.5	20.4	18
		10	10KBTP10MVX	54	24.2	18
9	11	10	11KBTP10MVX	61	24.2	23
		13	11KBTP13MVX	64.5	27.9	23

10/11KBPR Coupler with valve, Push-Lok 90°

Brass, FKM

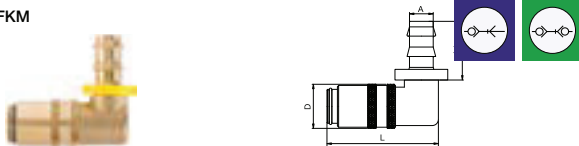

DN	Series	A		L	L1	D
6	10	6	10KBPR06MVX	46	20.4	18
		10	10KBPR10MVX	46	24.2	18
9	11	10	11KBPR10MVX	56.5	24.2	23
		13	11KBPR13MVX	56.5	27.9	23

10/11KBPH Coupler with valve, Push-Lok 45°

Brass, FKM

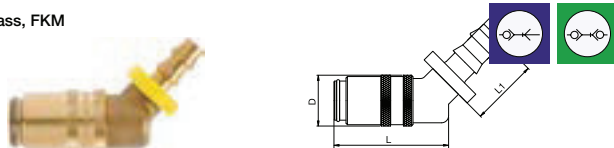

DN	Series	A		L	L1	D
6	10	6	10KBPH06MVX	41	20.4	18
		10	10KBPH10MVX	41	24.2	18
9	11	10	11KBPH10MVX	51	24.2	23
		13	11KBPH13MVX	51	27.9	23



Straight-Through / Single Shut-off

10/11/12SFA Plug without valve, Male Thread

Brass or stainless steel

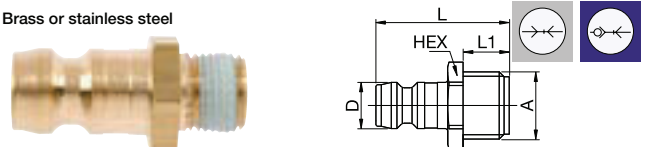

DN	Series	A		HEX	L	L1	D	Version
6	10	M8 x 0.75	10SFAM08MXX	11	24	7	9	Brass
		M10 x 1	10SFAM10MXX	11	24	7	9	Brass
		M10 x 1	10SFAM10RXX	11	24	7	9	AISI 303
		G1/8	10SFAW10MXN	11	24	7	9	Nickel-plated brass
		G1/8	10SFAW10RXX	11	24	7	9	AISI 303
		M12 x 1.5	10SFAM12MXX	14	27	10	9	Brass
		G1/4	10SFAW13MXN	15	26	9	9	Nickel-plated brass
		G1/4	10SFAW13RXX	15	26	9	9	AISI 303
		M14 x 1.5	10SFAM14MXX	15	26	9	9	Brass
		G3/8	10SFAW17MXN	17	30	10	9	Nickel-plated brass
		G1/8	11SFAW10MXN	14	25	8	13.5	Nickel-plated brass
		G1/4	11SFAW13MXN	15	26	9	13.5	Nickel-plated brass
9	11	G1/4	11SFAW13RXX	15	26	9	13.5	AISI 303
		M14 x 1.5	11SFAM14MXX	15	26	9	13.5	Brass
		M16 x 1.5	11SFAM16MXX	17	26	9	13.5	Brass
		G3/8	11SFAW17MXN	17	26	9	13.5	Nickel-plated brass
13	12	G3/8	11SFAW17RXX	17	26	9	13.5	AISI 303
		G1/2	12SFAW21MXN	22	47	12	19	Nickel-plated brass
		G3/4	12SFAW26MXN	27	51	16	19	Nickel-plated brass

10/11SFAR Plug without valve, Male Thread 90° tapered

Brass

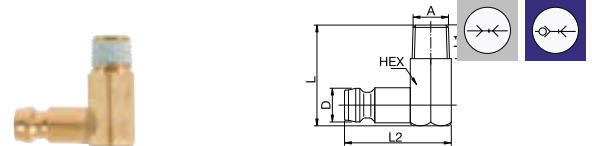

DN	Series	A		HEX	L	L1	L2	D	Version
6	10	M10 x 1	10SFAR10MXX	11	27	9	28.5	9	Brass
		R1/8	10SFAR10MXN	11	27	9	28.5	9	Nickel-plated brass
		R1/4	10SFAR13MXN	11	27	9	28.5	9	Nickel-plated brass
9	11	R1/4	11SFAR13MXN	15	34	11	32	13.5	Nickel-plated brass
		R3/8	11SFAR17MXN	15	34	11	32	13.5	Nickel-plated brass



Straight-Through / Single Shut-off

10/11SFIW Plug without valve, Female Thread

Brass

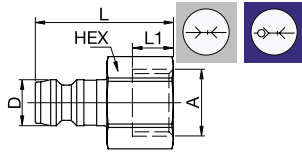

DN	Series	A	HEX	L	L1	D	
6	10	G1/8	10SFIW10MXN	11	24	9	9
		G1/4	10SFIW13MXN	16	27	9	9
9	11	G1/4	11SFIW13MXN	16	33	10	13.5

10/11/12SFTF Plug without valve, Hose Barb

Brass

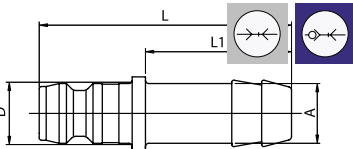

DN	Series	A	L	L1	D	
6	10	9	10SFTF09MXX	38	22	9
9	11	9	11SFTF09MXX	41	25	13.5
		13	11SFTF13MXX	41	25	13.5
13	12	19	12SFTF19MXX	61	32	19



Straight-Through / Single Shut-off

10/11/12SBA Plug with valve, Male Thread

Brass, FKM

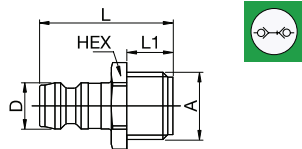

DN	Series	A	HEX	L	L1	D	Version	
6	10	G1/4	10SBAW13MVN	15	29	12	9	Nickel-plated brass
		M14 x 1.5	10SBAM14MVX	15	29	12	9	Brass
9	11	G1/4	11SBAW13MVN	15	31	12	13.5	Nickel-plated brass
		M16 x 1.5	11SBAM16MVX	17	30	12	13.5	Brass
13	12	G3/8	11SBAW17MVN	17	30	12	13.5	Nickel-plated brass
		G3/4	12SBAW26MVN	27	51	16	19	Nickel-plated brass

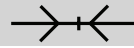

Straight-Through

10/11VN Extension Plug, continuous Male Thread

Brass

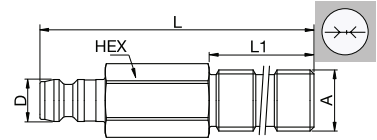

DN	Series	A	HEX	L	L1	D	
6	10	G1/8	10VN1010MXX	11	100	60	9
		G1/4	10VN1310MXX	14	100	60	9
9	11	G1/4	11VN1310MXX	14	100	60	13.5
		G3/8	11VN1710MXX	19	100	60	13.5

10/11VNXX Extension Plug, without Thread

Brass

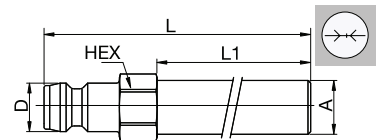

DN	Series	A	HEX	L	L1	D	
6	10	8	10VNXX10MXX	9	100	79	9
		10	10VNXX12MXX	11	120	100	9
		10	10VNXX24MXX	11	240	220	9
9	11	14	11VNXX15MXX	15	150	125	13.5
		14	11VNXX30MXX	15	300	275	13.5



SL

The 10 and 11 Rectus Moldtite coupling series with Safe-Lock technology were especially developed for connecting coolant lines and injection moulds. These stand out for their convenient, single-handed operation and a reliable O-ring seal. Widely used in Europe.

- Available in:
 - single shut-off, double shut-off or straight-through versions
- The straight-through couplings are equipped with nickel plated sleeves for quick and accurate visual differentiation
- The angular connections prevent kinks from forming in the hose
- Available on request:
 - series 10/11 are also available with special FFKM high-temperature seal for applications up to constant temperature 200°C

Series 10

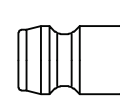

Series 11

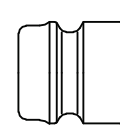

KF Straight-Through

Working Pressure*:
up to 15 bar

Material:

- Coupling: Brass
- Plug: Brass, stainless steel
- Seals: FKM

Working Temperature:

-15°C up to +200°C (FKM)

Flow Rate Water:

- Series 10: 16 l/min.
- Series 11: 50 l/min.

pressure drop 0.5 bar

KA Single Shut-Off

Working Pressure*:
up to 15 bar

Material:

- Coupling: Brass
- Plug: Brass, stainless steel
- Seals: FKM

Working Temperature:

-15°C up to +200°C (FKM)

Flow Rate Water:

- Series 10: 8 l/min.
- Series 11: 20 l/min.

pressure drop 0.5 bar

KB Double Shut-Off

Working Pressure*:
up to 15 bar

Material:

- Coupling: Brass
- Plug: Brass
- Seals: FKM

Working Temperature:

-15°C up to +200°C (FKM)

Flow Rate Water:

- Series 10: 7 l/min.
- Series 11: 15 l/min.

pressure drop 0.5 bar

* maximum static working pressure with design factor 4 to 1.

→|← Straight-Through

10/11KFA Coupler without valve, Male Thread, Safe-Lock

Brass, FKM

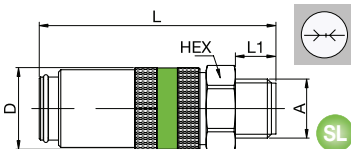

DN	Series	A	HEX	L	L1	D
6	10	G1/4	17	52.5	9	18
		M14 x 1.5	17	52.5	9	18
		G3/8	19	52.5	9	18
9	11	G1/4	22	62	9	24
		M16 x 1.5	22	62	9	24
		G3/8	22	62	9	24
		G1/2	22	65	12	24

→|← Straight-Through

10/11KFTR Coupler without valve, Hose Barb 90°, Safe-Lock

Brass, FKM

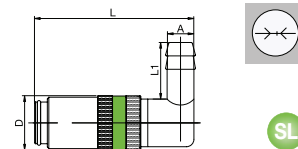

DN	Series	A	L	L1	D
6	10	9	53.5	22	18
9	11	13	63.5	28.5	24

10/11KFTF Coupler without valve, Hose Barb, Safe-Lock

Brass, FKM

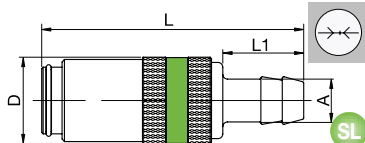
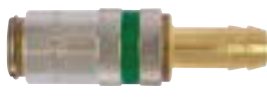

DN	Series	A	L	L1	D
6	10	9	60	22	18
9	11	13	71	25	24

10/11KFTH Coupler without valve, Hose Barb 45°, Safe-Lock

Brass, FKM

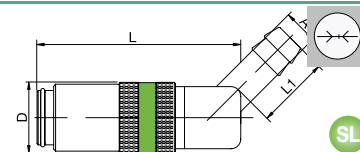

DN	Series	A	L	L1	D
6	10	9	60	22	18
9	11	13	60.5	25	24

Series 10/11 - Safe Locking Technology



Double Shut-off

10/11KBA Coupler with valve, Male Thread, Safe-Lock

Brass, FKM

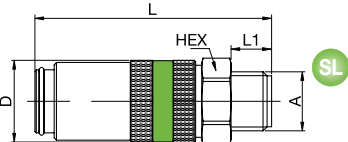

SL

DN	Series	A		HEX	L	L1	D
6	10	G1/4	10KBAW13MVXSL	17	52.5	9	18
		M14 x 1.5	10KBAM14MVXSL	17	52.5	9	18
		G3/8	10KBAW17MVXSL	19	52.5	9	18
9	11	G1/4	11KBAW13MVXSL	22	62	9	24
		M16 x 1.5	11KBAM16MVXSL	22	62	9	24
		G3/8	11KBAW17MVXSL	22	62	9	24
		G1/2	11KBAW21MVXSL	22	65	12	24

10/11KBT Coupler with valve, Hose Barb, Safe-Lock

Brass, FKM

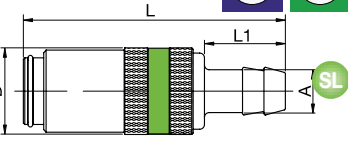

SL

DN	Series	A		L	L1	D
6	10	9	10KBTf09MVXSL	60	22	18
9	11	13	11KBTf13MVXSL	71	25	24



Double Shut-off

10/11KBTR Coupler with valve, Hose Barb 90°, Safe-Lock

Brass, FKM

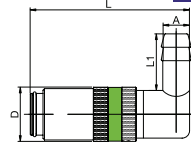
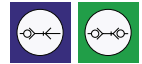

SL

DN	Series	A		L	L1	D
6	10	9	10KBTR09MVXSL	53.5	22	18
9	11	13	11KBTR13MVXSL	63.5	28.5	24

10/11KBTH Coupler with valve, Hose Barb 45°, Safe-Lock

Brass, FKM

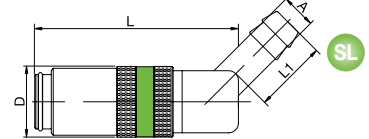

SL

DN	Series	A		L	L1	D
6	10	9	10KBTH09MVXSL	60	22	18
9	11	13	11KBTH13MVXSL	60.5	25	24



SV

The 10 and 11 Rectus Moldtite coupling series with Safety Lock were especially developed for connecting coolant lines and injection moulds. These stand out for their convenient, single-handed operation and a reliable O-ring seal. Widely used in Europe. Coupling system with safety locking. Accidental uncoupling is prevented effectively and easily with the automatic safety lock.

- Available in:
 - single shut-off, double shut-off or straight-through versions
- The straight-through couplings are equipped with nickel plated sleeves for quick and accurate visual differentiation
- The angular connections prevent kinks from forming in the hose
- Available on request:
 - series 10/11 are also available with special FFKM high-temperature seal for applications up to constant temperature 200°C

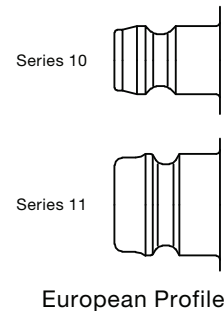

KF Straight-Through

Working Pressure*:
up to 15 bar

Material:

- Coupling: Brass
- Plug: Brass, stainless steel
- Seals: FKM

Working Temperature:
-15°C up to +200°C (FKM)

Flow Rate Water:

- Series 10: 16 l/min.
- Series 11: 50 l/min.

pressure drop 0.5 bar

KA Single Shut-Off

Working Pressure*:
up to 15 bar

Material:

- Coupling: Brass
- Plug: Brass, stainless steel
- Seals: FKM

Working Temperature:
-15°C up to +200°C (FKM)

Flow Rate Water:

- Series 10: 8 l/min.
- Series 11: 20 l/min.

pressure drop 0.5 bar

KB Double Shut-Off

Working Pressure*:
up to 15 bar

Material:

- Coupling: Brass
- Plug: Brass
- Seals: FKM

Working Temperature:
-15°C up to +200°C (FKM)

Flow Rate Water:

- Series 10: 7 l/min.
- Series 11: 15 l/min.

pressure drop 0.5 bar

* maximum static working pressure with design factor 4 to 1.

→|← Straight-Through

10/11KFA Coupler without valve, Male Thread

Brass, FKM

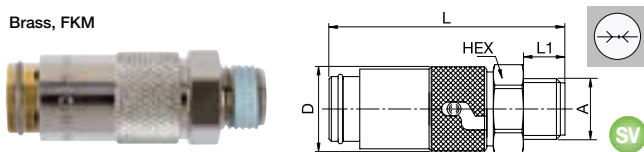

DN	Series	A	HEX	L	L1	D
6	10	G1/4	10KFAW13MVXSV	17	51	9 18
		M14 x 1.5	10KFAM14MVXSV	17	51	9 18
		G3/8	10KFAW17MVXSV	19	51	9 18
9	11	G1/4	11KFAW13MVXSV	22	59.5	9 23
		M16 x 1.5	11KFAM16MVXSV	22	59.5	9 23
		G3/8	11KFAW17MVXSV	22	59.5	9 23
		G1/2	11KFAW21MVXSV	22	62.5	12 23

→|← Straight-Through

10/11KFAR Coupler without valve, Male Thread 90°

Brass, FKM

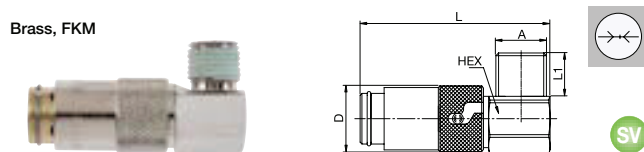

DN	Series	A	HEX	L	L1	D
6	10	G1/4	10KFAR13MVXSV	17	52.5	12 18
		M14 x 1.5	10KFAR14MVXSV	17	52.5	12 18
9	11	M16 x 1.5	11KFAR16MVXSV	22	61.5	12 23

10/11KFAH Coupler without valve, Male Thread 45°

Brass, FKM

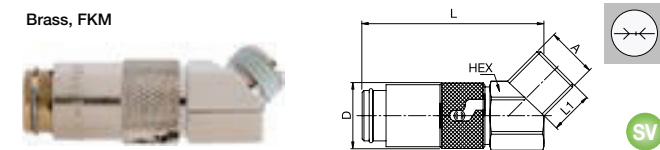

DN	Series	A	HEX	L	L1	D
6	10	G1/4	10KFAH13MVXSV	17	52.5	9 18
		M14 x 1.5	10KFAH14MVXSV	17	52.5	9 18
9	11	M16 x 1.5	11KFAH16MVXSV	22	61.5	9 23

Series 10/11 - Safe Locking Technology



Straight-Through

10/11KFTF Coupler without valve, Hose Barb

Brass, FKM

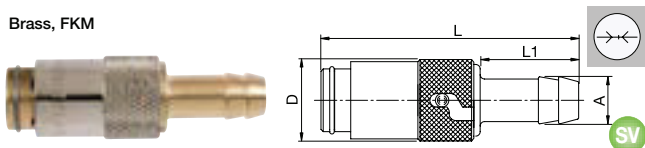

DN	Series	A		L	L1	D
6	10	9	10KFTF09MVXSV	57.5	22	18
9	11	13	11KFTF13MVXSV	68.5	25	23

10/11KFTR Coupler without valve, Hose Barb 90°

Brass, FKM

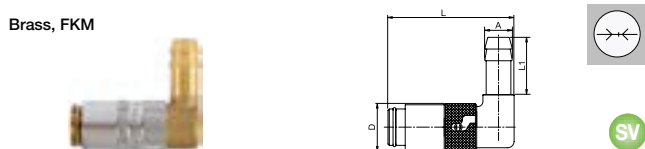

DN	Series	A		L	L1	D
6	10	9	10KFTR09MVXSV	48.5	22	18
9	11	13	11KFTR13MVXSV	56	28	23

10/11KFTH Coupler without valve, Hose Barb 45°

Brass, FKM

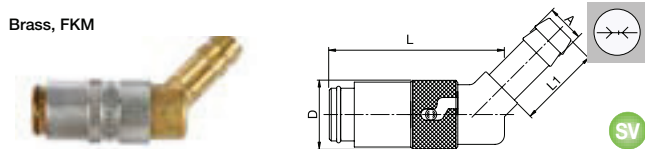

DN	Series	A		L	L1	D
6	10	9	10KFTH09MVXSV	46.5	22	18
9	11	13	11KFTH13MVXSV	56	28	23



Single Shut-off / Double Shut-off

10/11KBA Coupler with valve, Male Thread

Brass, FKM

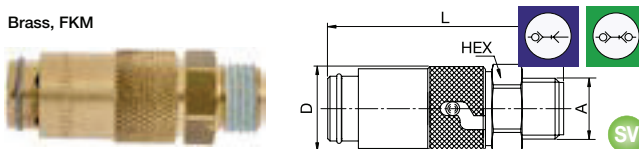

DN	Series	A		HEX	L	L1	D
6	10	G1/4	10KBAW13MVXSV	17	51	9	18
		M14 x 1.5	10KBAM14MVXSV	17	51	9	18
		G3/8	10KBAW17MVXSV	19	51	9	18
9	11	G1/4	11KBAW13MVXSV	22	59.5	9	23
		M16 x 1.5	11KBAM16MVXSV	22	59.5	9	23
		G3/8	11KBAW17MVXSV	22	59.5	9	23
		G1/2	11KBAW21MVXSV	22	62.5	12	23

10/11KBAR Coupler with valve, Male Thread 90°

Brass, FKM

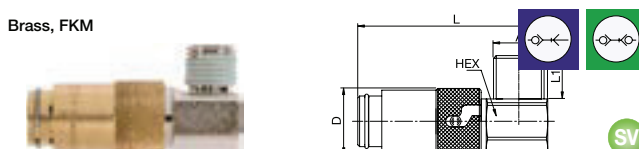

DN	Series	A		HEX	L	L1	D
6	10	G1/4	10KBAR13MVXSV	17	52.5	12	18
		M14 x 1.5	10KBAR14MVXSV	17	52.5	12	18
9	11	M16 x 1.5	11KBAR16MVXSV	22	61.5	12	23

10/11KBAH Coupler with valve, Male Thread 45°

Brass, FKM

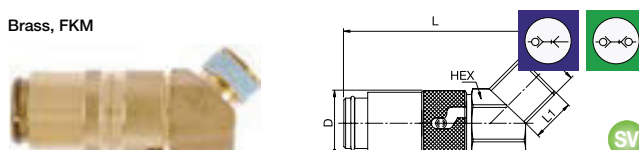

DN	Series	A		HEX	L	L1	D
6	10	G1/4	10KBAH13MVXSV	17	52.5	9	18
		M14 x 1.5	10KBAH14MVXSV	17	52.5	9	18
9	11	M16 x 1.5	11KBAH16MVXSV	22	61.5	9	23

10/11KBTF Coupler with valve, Hose Barb

Brass, FKM

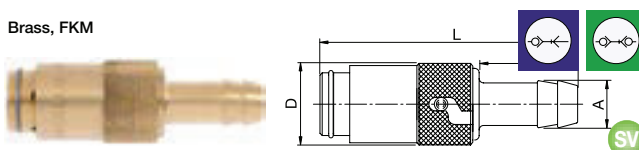

DN	Series	A		L	L1	D
6	10	9	10KBTF09MVXSV	57.5	22	18
9	11	13	11KBTF13MVXSV	68.5	25	23

Series 10/11 - Safe Lock Technology



Single Shut-off / Double Shut-off

10/11KBTR Coupler with valve, Hose Barb 90°

Brass, FKM

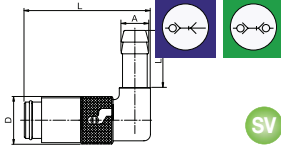

SV

DN	Series	A		L	L1	D
6	10	9	10KBTR09MVXSV	48.5	22	18
9	11	13	11KBTR13MVXSV	56	28	23

10/11KBTH Coupler with valve, Hose Barb 45°

Brass, FKM

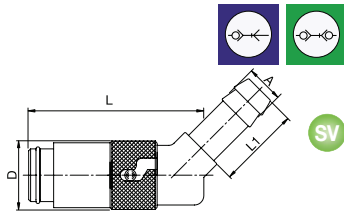

SV

DN	Series	A		L	L1	D
6	10	9	10KBTH09MVXSV	46.5	22	18
9	11	13	11KBTH13MVXSV	56	28	23



The 608 series (French series) has been specially developed for cooling in the field of plastic injection machines / moulds. Using vertical plug inserts, the cooling connection can be installed directly in the mould / machine, so the external contour has no protruding extension components. This allows easy and safe handling during the work process and prevents damage to the coupling and the mould. This system is supplied as a "straight-through coupling" with no valves. Coding of the in and outlets can be represented by simple fixing of the coloured clips / rings onto the coupling and plug.

The use of the locking balls means that an optimum grip of the plug connection is guaranteed, even with forces that are applied laterally. The simple unlocking mechanism, which is optimised by knurling at the end of the sleeve, can be operated by pulling back once on the sleeve.

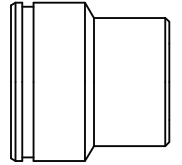

French Profile

KF Straight-Through

Working Pressure*:
up to 20 bar

Material:

- Coupling: Nickel plated brass
- Plug: Nickel plated brass
- Seals: FKM

Working Temperature:
-15°C up to +200°C (FKM)

Flow Rate Water:
32 l/min.
pressure drop 0.5 bar

* maximum static working pressure with design factor 4 to 1.

→|← Straight-Through

608KFIW Coupler without valve, Female Thread

Nickel-plated brass, FKM

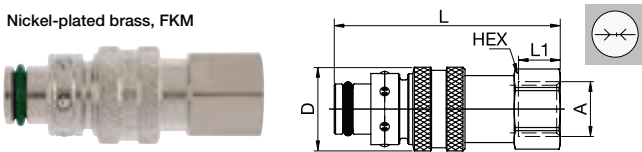

A	HEX	L	L1	D	
G1/4	608KFIW13MVN	17	54	10	20

→|← Straight-Through

608KFTP Coupler without valve, Push-Lok

Nickel-plated brass, FKM

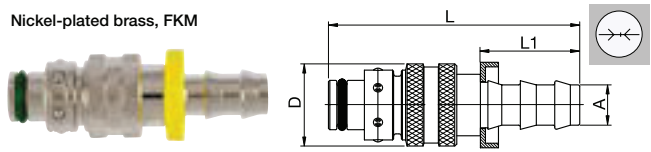

A	L	L1	D	
10	608KFTP10MVN	61	24	20
13	608KFTP13MVN	66.5	28	20

608KFTF Coupler without valve, Hose Barb

Nickel-plated brass, FKM

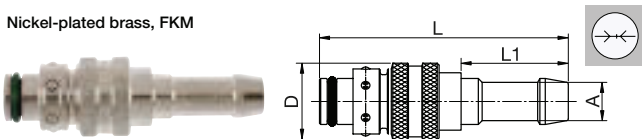

A	L	L1	D	
8	608KFTF08MVN	65	28	20
10	608KFTF10MVN	65	28	20
12	608KFTF12MVN	65	28	20

608KFTR Coupler without valve, Hose Barb 90°

Nickel-plated brass, FKM

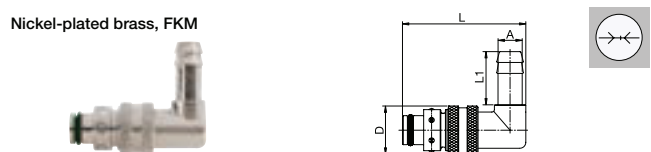

A	L	L1	D	
10	608KFTR10MVN	51	20	20
12	608KFTR12MVN	51	20	20



Straight-Through

608KFTH Coupler without valve, Hose Barb 45°

Nickel-plated brass, FKM

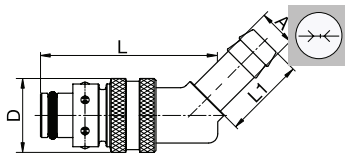

A		L	L1	D
10	608KFTH10MVN	51	20	20
12	608KFTH12MVN	51	20	20

608KFPR Coupler without valve, Push-Lok 90°

Nickel-plated brass, FKM

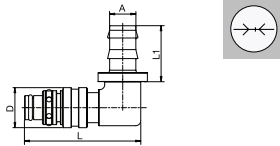

A		L	L1	D
10	608KFPR10MVN	54.5	24	20
13	608KFPR13MVN	58	28	20

608KFPH Coupler without valve, Push-Lok 45°

Nickel-plated brass, FKM

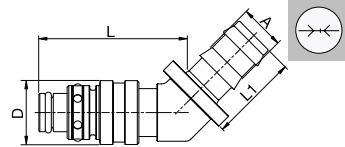

A		L	L1	D
10	608KFPH10MVN	44.5	24	20
13	608KFPH13MVN	47	28	20



Straight-Through

608SFA Plug without valve, Male Thread

Nickel-plated brass

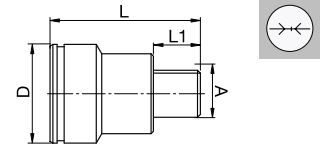

A		HEX	L	L1	L2	D
M10 x 1	608SFAM10MXN	6	32	10		21
G1/8	608SFAW10MXN	6	32	10		21
G1/4	608SFAW13MXN	8	33	12		21
G3/8	608SFAW17MXN	8	24	13		21
R1/8	608SFAR10MXN		34	11	33	22
G1/4	608SFAR13MXN		37	13	33	22
G3/8	608SFAR17MXN		37	13	33	22
R1/8	608SFAH10MXN		33	10.5		22
R1/4	608SFAH13MXN		35	13		22

608SFIW Plug without valve, Female Thread

Nickel-plated brass

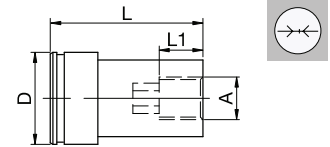

A		HEX	L	L1	D
G1/8	608SFIW10MXN	6	35	10	21
G1/4	608SFIW13MXN	8	40	14	21

608VN Extension Plug, Male Thread

Nickel-plated brass

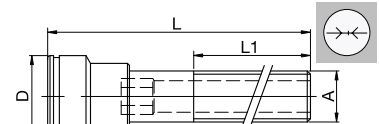

A		HEX	L	L1	D
G1/8	608VN1005MXN	6	50	28	21
G1/8	608VN1010MXN	6	100	60	21
G1/8	608VN1015MXN	6	150	60	21
G1/4	608VN1305MXN	8	50	28	21
G1/4	608VN1310MXN	8	100	60	21
G1/4	608VN1315MXN	8	150	60	21

DHX608 Color Clip for Couplings and Plugs

POM



A		Color
Clip for Coupling	DHX608KXXXR	RED
Clip for Coupling	DHX608KXXXB	BLUE
Clip for Coupling	DHX608KXXXS	BLACK
Clip for Plug	DHX608SXXXR	RED
Clip for Plug	DHX608SXXXB	BLUE
Clip for Plug	DHX608SXXXS	BLACK



Modular integrated coupling and plug for installation in multi-coupling systems. High resilience, low coupling forces and great resistance to liquid media due to the special coating of the coupling body

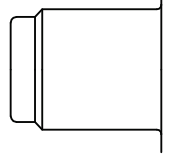

KF Straight-Through

Working Pressure*:
up to 15 bar

Material:

- Coupling: Nickel plated brass, PTFE coated steel
- Plug: Nickel plated brass, PTFE coated steel
- Seals: FKM

Working Temperature:
-15°C up to +100°C (FKM)

Flow Rate Water:
46 l/min.
pressure drop 0.5 bar

KL Dry-break

Working Pressure*:
up to 15 bar

Material:

- Coupling: Nickel plated brass, PTFE coated steel
- Plug: Nickel plated brass, PTFE coated steel
- Seals: FKM

Working Temperature:
-15°C up to +100°C (FKM)

Flow Rate Water:
20 l/min.
pressure drop 0.5 bar

* maximum static working pressure with design factor 4 to 1.

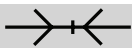

Straight-Through



Dry-Break

93KFIW Coupler without valve, Female Thread

Nickel-plated brass, Steel PTFE coated, FKM

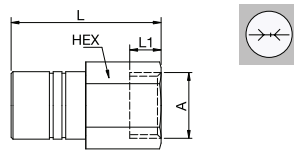

DN	A	HEX	L	L1
8.1	G1/2	93KFIW21SVN	24	48 12

93KLIW Coupler with valve, Female Thread

Nickel-plated brass, Steel PTFE coated, FKM

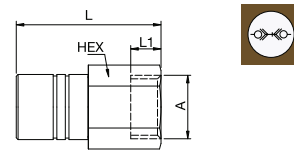

DN	A	HEX	L	L1
8.1	G1/2	93KLIW21SVN	24	48 12

93SFIW Plug without valve, Female Thread

Nickel-plated brass, Steel PTFE coated

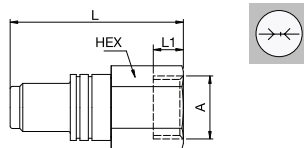

DN	A	HEX	L	L1
8.1	G1/2	93SFIW21SXN	24	57.5 12

93SLIW Plug with valve, Female Thread

Nickel-plated brass, Steel PTFE coated, FKM

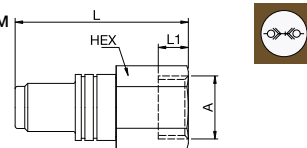

DN	A	HEX	L	L1
8.1	G1/2	93SLIW21SVN	24	57.5 12

94KX Locking Coupling

Nickel-plated steel

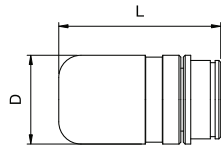

L D

94KX

45 25

94SX Locking Bolt

Nickel-plated steel

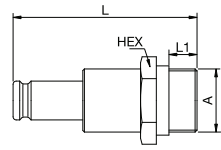

HEX L L1

94SX

24 58 13

QH Ferrules

Stainless Steel

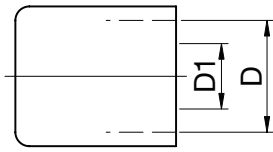

D D1

QH1510	15	11.5
QH1610	17	11.5
QH1810	18.5	13.7
QH1913	19	14.2
QH2013	20.5	14.5
QH2213	21.7	15
QH2313	23.5	17.5
QH2919	28.5	22

PM Crimper



D

PM10-36	10 - 36
---------	---------

MHE EPDM-Hoses

EPDM

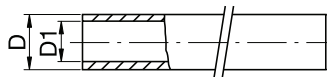

	Max. Working Length in m	Reference Ferrule	D	D1	Color
MHE1050B	50	1610	16.5	9.5	BLUE
MHE1050R	50	1610	16.5	9.5	RED
MHE1050S	50	1610	16.5	9.5	BLACK
MHE1350B	50	2313	21.5	12.7	BLUE
MHE1350R	50	2313	21.5	12.7	RED
MHE1350S	50	2313	21.5	12.7	BLACK
MHE1930B	30	2919	27	19	BLUE
MHE1930R	30	2919	27	19	RED
MHE1930S	30	2919	27	19	BLACK

Compatible fluid : Water, up to 20 bar, up to +140°C

MHN NBR-Hoses

NBR

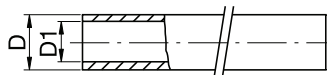

	Max. Working Length in m	Reference Ferrule	D	D1	Color
MHN1050S	50	1610	15.9	9.5	BLACK
MHN1350S	50	2213	19.8	12.7	BLACK

Compatible fluid : oil, up to 28 bar, up to +135°C

MHP PVC-Hoses

PVC

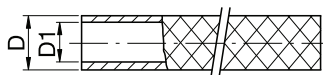

	Max. Working Length in m	Reference Ferrule	D	D1	Color
MHP1030T	30	1610	16	10	TRANSPARENT
MHP1030B	30	1610	16	10	BLUE
MHP1030R	30	1610	16	10	RED
MHP1330T	30	1913	19	13	TRANSPARENT
MHP1330B	30	1913	19	13	BLUE
MHP1330R	30	1913	19	13	RED
MHP1930T	50	2919	27	19	TRANSPARENT

Compatible fluid : Water, up to 15 bar, up to +60°C

MHS Silicone-Hoses

Silicone



	Max. Working Length in m	Reference Ferrule	D	D1	Color
MHS1025	25	1510	14	9.5	SILVER
MHS1025B	25	1510	14	9.5	BLUE
MHS1025R	25	1510	14	9.5	RED
MHS1325	25	1913	17.5	13	SILVER
MHS1325B	25	1913	17.5	13	BLUE
MHS1325R	25	1913	17.5	13	RED

Compatible fluid : Water, up to 25 bar, up to +170°C

MHF FKM-Hoses

FKM

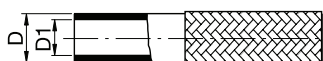

	Max. Working Length in m	Reference Ferrule	D	D1	Color
MHF1025	25	1510	23	16	SILVER
MHF1325	25	1913	26	19	SILVER

Compatible fluid : Oil /Water, up to 15 bar, up to +130°C



Midi series are adapted for water and compressed air applications. The wide range of plugs allows many combinations for the end-users.

- Designed for transmission of water and fluids
- High flow capabilities
- Maximum energy efficiency

own Profile

KA Single Shut-Off

Working Pressure*:
up to 20 bar

Material:

- Coupling: Nickel plated brass
- Plug: Nickel plated brass
- Seals: NBR

Working Temperature:
-20°C up to +100°C (NBR)

Flow Rate Air:
2.200 NI/min.
inlet pressure 6 bar, pressure drop 0.6 bar

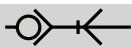

Single Shut-Off

0172 Coupler with valve, Female BSPP Thread

Nickel-plated brass, NBR

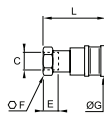

DN	C		E	F	G	L
12	G3/8	0172 12 17	16	27	29	56
12	G1/2	0172 12 21	16	27	29	56

Midi Series: single shut-off = 2200NI/min

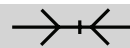

Straight-Through

2272 Coupler without valve, Female BSPP Thread

Nickel-plated brass, NBR

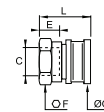

DN	C		E	F	G	L
12	G1/2	2272 12 21	10	24	29	33
12	G3/4	2272 12 27	10	30	29	34.5
12	G1	2272 12 34	10	36	29	34.5

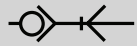

Single Shut-Off

2511 Coupler with valve, with Barb Connection for Hose

Nickel-plated brass, NBR

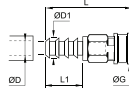

DN	ØD	ØD1		G	L	L1
12	12	13.5	2511 12 12	29	75	32
12	15	16.5	2511 12 15	29	75	32
12	19	20.5	2511 12 19	29	81	38

Midi Series: single shut-off = 2200NI/min

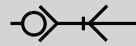

Straight-Through

2296 Plug without valve, Female BSPP Thread

Nickel-plated brass

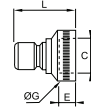

DN	C		E	G	L
12	G1/2	2296 12 21	11	24	31.5
12	G3/4	2296 12 27	11	30	38
12	G1	2296 12 34	11	36	36.5

Probe without Shut-off

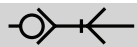

Straight-Through

2297 Coupler without valve, with Barb Connection for Hose

Nickel-plated brass, NBR

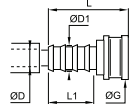

DN	ØD	ØD1		G	L	L1
12	12	13.5	2297 12 12	29	51	27
12	15	16.5	2297 12 15	29	51	27
12	19	20.5	2297 12 19	29	57	33

0195 Plug without valve, with Barb Connection for Flexible Tubing

Nickel-plated brass

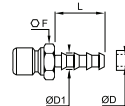

DN	ØD	ØD1		F	L
12	7	9	0195 07 00	17	29.5
12	10	12.2	0195 10 00	17	29.5
12	13	15.2	0195 13 00	17	29.5
12	16	18.5	0195 16 00	21	36.5

Probe without Shut-off

2294 Plug without valve, Male BSPP Thread

Nickel-plated brass

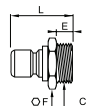

DN	C		E	F	L
12	G3/8	2294 12 17	6	22	31.5
12	G1/2	2294 12 21	9.5	22	37
12	G3/4	2294 12 27	13.5	27	41
12	G1	2294 12 34	10.5	34	36

Probe without Shut-off

2295 Plug without valve, with Barb Connection for Flexible Hose

Nickel-plated brass

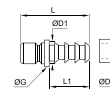

DN	ØD	ØD1		G	L	L1
12	12	13.5	2295 12 12	17	48	27
12	15	16.5	2295 12 15	18	48	27
12	19	20.5	2295 12 19	24	57	33

Probe without Shut-off

0196 Plug without valve, Female BSPP Thread

Nickel-plated brass

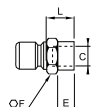

DN	C		E	F	L
12	G1/4	0196 12 13	12	17	16
12	G3/8	0196 12 17	12	21	15
12	G1/2	0196 12 21	14	26	17

Probe without Shut-off

2293 Y Coupler, Straight Through

Nickel-plated brass, NBR

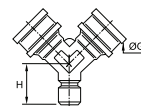

DN		G	H
12	2293 12 00	29	27

Probe without Shut-off

Midi Series: straight-through = 2200 NI/min

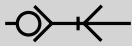

Straight-Through

2270 Coupler without valve, with Tap, Male BSPP Thread

Nickel-plated brass, NBR

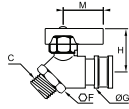

DN	C		F	G	H
12	G1/2	2270 21 00	28	29	40.5

Flow = 2200 NI/min

2292 Universal Coupler Adaptor

Nickel-plated brass, NBR

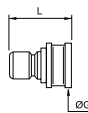

DN			G	L
12		2292 12 00	29	40.5

Without shut-off
This adaptor provides interchangeability with numerous components (especially watering accessories).

2398 Universal Plug Adaptor

Nickel-plated brass, NBR

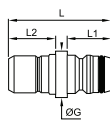

DN			G	L	L1	L2
12		2398 12 01	20	43	19	18.5

This adaptor provides interchangeability with numerous components (especially watering accessories).

2299 Water Pistol

Zamak, nickel-plated brass, NBR

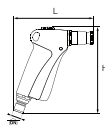

DN			H	L
12		2299 12 01	140	126
12		2299 12 20		77.4

This pistol allows independent control of:
- the flow rate (trigger)
- type of jet (adjustable to a fine mist) by the adjustable nozzle



The robust maxi series is designed for high flow applications and ensure water and compressed air handling.

- Designed for transmission of water and fluids
- Very High flow capabilities
- Ideal for rincing applications

own Profile



KF Straight-Through

Working Pressure*:
up to 20 bar

Material:

- Coupling: Nickel plated brass
- Plug: Nickel plated brass
- Seals: NBR

Working Temperature:
-20°C up to +100°C (NBR)

Flow Rate Air:
8.500 NI/min.
inlet pressure 6 bar, pressure drop 0.6 bar

→|← Straight-Through

2272 Coupler without valve, Female BSPP Thread

Nickel-plated brass, NBR

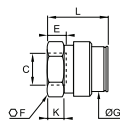

DN	C	E	F	G	K	L	
19	G1	2272 18 34	9	36	42	11	45

Maxi-series: straight-through = 8500 NI/min

→|← Straight-Through

2294 Plug without valve, Male BSPP Thread

Nickel-plated brass

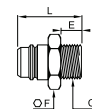

DN	C	E	F	L	
19	G3/4	2294 18 27	10.5	27	42.5
19	G1	2294 18 34	13	34	46

Probe without Shut-off

2297 Coupler without valve, with Barb Connection for Flexible Hose

Nickel-plated brass, NBR

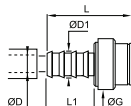

DN	ØD	ØD1	G	L	L1	
19	19	20.7	2297 18 20	39.5	69	37

Maxi-series: straight-through = 8500 NI/min

2295 Plug without valve, with Barb Connection for Flexible Hose

Nickel-plated brass

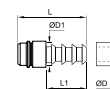

DN	ØD	ØD1	L	L1	
19	19	21	2295 18 20	69	41

Probe without Shut-off

#03

TUBING, HOSE & BLOWGUNS

Flexible Calibrated Tubing

Calibrated Multi-Tubing

Calibrated Recoil Tubing and Hose

Calibrated Braided Hose

Accessories

Blowguns



How to Choose Your Tubing & Hoses ?

Key points to consider before choosing your tubing & hoses

What is the difference between Tubing and Hose ?

- **Tubing:** Gripping and sealing are on the O.D of the calibrated tubing. Full bore for optimum flow.
- **Hoses:** Gripping and sealing are on the I.D. of the hose. Connection and sealing achieved through the distortion of the hose.

What are the conditions of use?

- Pressure
- Temperature inside the system
- Type of fluid conveyed
- U.V. exposure



Have you thought about additional requirements ?

- Push-in fittings
- Compression fittings
- Spigot fittings
- Blowguns
- Couplings
- Tail piece adaptors









What type of packaging do you need ?







- Depending of the length:
- Tubepack® (5 to 100 m)
 - Drums (40 to 1000 m)
 - Reels (25 to 50 m)

Do you have compliance requirements ?

- RoHS
- PED
- REACH
- UL94
- 1935/2004/CE
- FDA

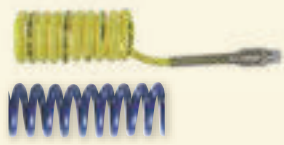
Product Specifications Overview

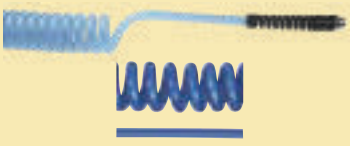
	Materials	Fluids	Maximum Pressure (bar)	Temperature		Performance in Aggressive Environments		Page
				Min.	Max.	Mechanical	Chemical	
Semi-Rigid PA 	Semi-rigid polyamide	Compressed air, industrial fluids	50	-40°C	+100°C	Good	Good	394
Rigid PA 	Rigid polyamide	Compressed air, industrial fluids	58	-40°C	+80°C	Good	Good	395
Fireproof High Resistance PA 	Polyamide with flame-retardant additive	Coolants, industrial fluids (lubricants), compressed air	50	-50°C	+100°C	Excellent	Moderate	396
Anti-Spark Resistance PA and PU 	Semi-rigid polyamide with PVC sheath Polyurethane ether with PVC sheath Single-layer polyurethane ether with flame-retardant additive	Compressed air, coolants, industrial fluids	36 (PA) 14 (PU)	-20°C	+70°C	Excellent	Good	397
PU 	Polyurethane ester Polyurethane ether "Crystal" food-quality polyurethane ether	Compressed air, industrial fluids (water) or food industry fluids	12	-20°C	+70°C	Excellent	Moderate Good Good	398
Antistatic PU 	Polyurethane filled with conductive particules	Compressed air	10	-20°C	+70°C	Excellent	Moderate	400
Advanced PE 	Advanced Polyethylene	Beverage, water	16	-40°C	+95°C	Good	Excellent	403
FEP 	Fluoropolymer: fluorinated ethylene propylene	All fluids	28	-40°C	+150°C	Good	Excellent	405
PFA 	Fluoropolymer: high purity and coloured perfluoroalkoxy FDA	All fluids	36	-40°C	+150°C	Excellent	Good	406

	Materials	Fluids	Maximum Pressure (bar)	Temperature		Performance in Aggressive Environments		Page
				Min.	Max.	Mechanical	Chemical	
Antistatic PFA 	Fluoropolymer: per-fluoroalkoxy filled with conductive particules	All fluids	36	-40°C	+150°C	Excellent	Good	406
Multi-Tubing 	Polyamide Polyurethane	Compressed air, chemicals, industrial fluids Compressed air, industrial fluids	24 14	-40°C -20°C	+80°C +70°C	Good	Good	407
PA Recoil Tubing - RECTULASTIC 	Polyamide	Compressed air, lubricants	20 16	-20°C -40°C	+80°C +90°C	Good	Good	408
PU Recoil Tubing - RECTUFLEX 	Polyurethane	Compressed air	10 11	-20°C -40°C	+70°C +75 °C	Excellent	Good	412
PVC Braided Hose - RECTUSOFT 	- Food-Grade PVC - Industrial-Grade PVC - RECTUSOFT: 3-Ply PVC	Compressed air	15	-20°C -25°C -15°C	+70°C +60°C +60°C	Excellent	Good	415
Self-Fastening NBR 	NBR with polyamide braid	Compressed air, coolants	16	-20°C	+100°C	Excellent	Good	417
Braided PU Recoil Hose - SUPERBRAID 	Polyurethane	Compressed air	15	-40°C	+75°C	Excellent	Good	419
PU inner Braided ULTRALITE SUPERBRAID 	Polyurethane reinforced with Dacron polyester	Compressed air	12	-40°C	+75°C	Excellent	Good	419
Accessories for Tubing 	Composite Brass Stainless steel	Compressed air, industrial fluids						421

Tubepack®

- 5 m, 10 m, 25 m and 100 m lengths
- For polyamide, polyurethane, fluoropolymer, polyethylene and anti-spark tubing
- Optimisation of tubing storage
- Immediate identification of the type of tubing
- Integrated winder for easy handling



5 m - 100 m

Drums

- Up to 1000 m long
- For polyamide, polyurethane, fluoropolymer tubing, etc.
- Immediate identification of the tubing for easy handling
- Adapted to workshop reels



40 m - 1000 m

Reels

- Up to 50 m
- Supplied with protective plastic film
- For braided tubing, special tubing (e.g. multi-tubing)



25 m - 50 m

Plastic Bags

- Ideal for merchandising
- Promotional tools
- Recoil tubing or tubing cut to the required length



Tube Marking

- Length indicated every metre:
 - time saved when cutting to exact length
 - remaining quantity is immediately identifiable (PA and PU)
- Custom marking upon request (marking, fluid identification, customer part number...)
- Traceability with marking of manufacturing batch

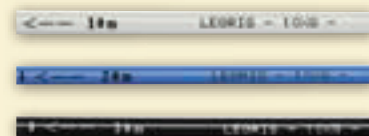

How to Read the Graphs

- In the graphs in this chapter, each curve represents the acceptable maximum pressure at a given temperature, by diameter.
- Technical characteristics of Parker Legris tubing depend on the type of connection used.
- The vacuum capability of all tubing is 755 mm Hg (99% vacuum).

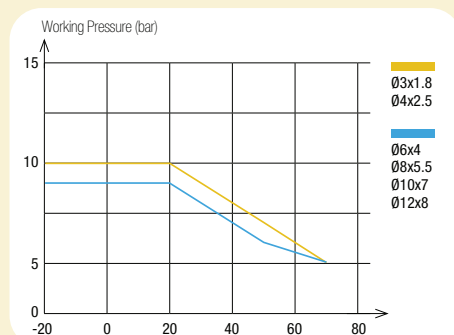

Product Codes of Parker Legris Tubing and Hose

Material

- H** = Self-Fastening NBR
- L** = Rigid Polyamide
- P** = Semi-Rigid Polyamide
- T** = Fluoropolymer
- U** = Polyurethane
- V** = PVC
- Y** = Polyethylene

Type of Tubing

- P.A** = Antistatic PA
- P.R** = Fireproof PA
- P.V** = Anti-Spark PA with PVC Sheath
- T.A** = Antistatic PFA
- T.P** = PFA
- U..A** = Antistatic PU
- U..K** = Anti-Spark Single Layer PU
- U..R** = PU Ether
- U..V** = Anti-Spark PU with PVC Sheath
- Y..F** = Advanced PE (LIQUIfit®)

2010 P 04 R 00 27

Packaging Code

1 = Tubepack® or LIQUIfit® Drum

Length

015 = 150 m
020 = 20 m
025 = 25 m
030 = 300 m
040 = 40 m
075 = 75 m
080 = 80 m
100 = 100 m

O.D. Code

03 = 3 mm
04 = 4 mm
06 = 6 mm
08 = 8 mm
 .../...
 56 mm = 1/4"
 .../...

Colour

00 = ○ clear
01 = ● black
02 = ● green
03 = ● red
04 = ● blue
05 = ● yellow
06 = ● grey
07 = ● orange
08 = ○ crystal clear
09 = ● purple
10 = ○ white
12 = ● crystal green
13 = ● crystal red
14 = ● crystal blue
17 = ● crystal orange

Special I.D.

18 = 1.8 mm
27 = 2.7 mm
33 = 3.3 mm
75 = 7.5 mm
95 = 9.5 mm

2 = Long Length on Drum

003 = 300 m
005 = 500 m
010 = 1000 m

10 = 10 mm
04 = 4 mm
06 = 6 mm
08 = 8 mm
10 = 10 mm
04 = 4 mm
06 = 6 mm



PA Tubing



PA tube is available in 2 grades: semi-rigid with a proven and durable offer thanks to its mechanical properties, rigid with a high-performance offer based on the Eco-Design approach.

Ø metric:
3 to 16 mm

Technical Characteristics		
Tubing	Semi-Rigid PA	Rigid PA
Compatible Fluids	Compressed air, other fluids	Compressed air, lubricants, other fluids
Working Pressure	Vacuum to 50 bar	Vacuum to 58 bar
Working Temperature	-40°C to +100°C	-40°C to +80°C
Component Materials	Bio-based polyamide (68 shore D)	Polyamide (65 shore D)

Reliable performance is dependent upon the type of fluid conveyed and fittings being used. Use is guaranteed with a vacuum of 755 mm Hg (99% vacuum).

Regulations	
Industrial:	Transportation:
<ul style="list-style-type: none"> • RoHS • PED • REACH 	<ul style="list-style-type: none"> • Chemical performance and resistance tested according to DIN 74324

Advantages
<ul style="list-style-type: none"> • Chemical stability • Marking on the tube of the remaining length. • Large color panel for circuit identification

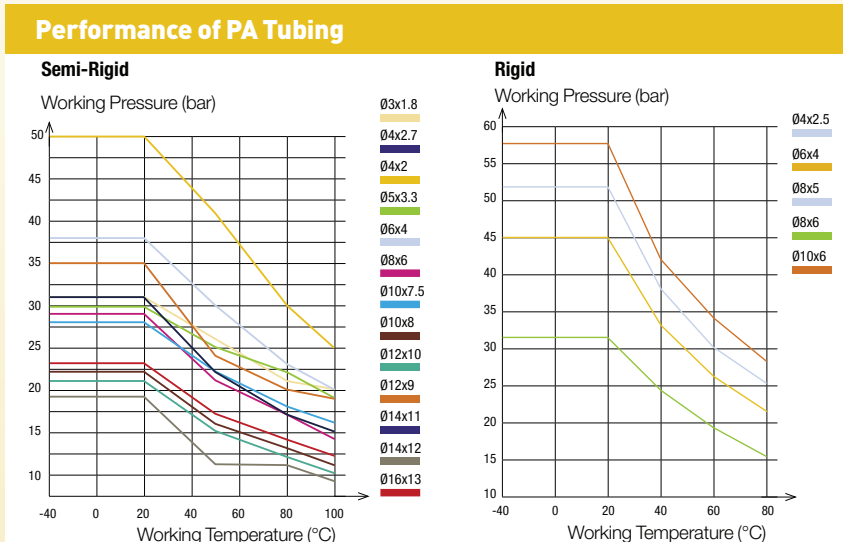

Tube O.D.	Tube O.D. Tolerance
3 to 5 mm	+0.05 / -0.08
6 to 16 mm	+0.05 / -0.10

Connected to Parker Legris push-in fittings, the calibration of Parker Legris tubing ensures perfect sealing in accordance with NF E49-100.

1025P Semi-Rigid Polyamide (PA) Tubing









Tubepack® 25 m

ØD ext.	ØD int.		clear								Kg
3	1.8	6	1025P03 00 18						1025P03 04 18		0.200
4	2	10	1025P04 00	1025P04 01	1025P04 02	1025P04 03	1025P04 04	1025P04 05			0.318
	2.7	10	1025P04 00 27	1025P04 01 27	1025P04 02 27	1025P04 03 27	1025P04 04 27	1025P04 05 27	1025P04 06 27		0.354
5	3.3	15	1025P05 00 33	1025P05 01 33					1025P05 04 33		0.420
6	4	15	1025P06 00	1025P06 01	1025P06 02	1025P06 03	1025P06 04	1025P06 05	1025P06 06		0.540
8	6	25	1025P08 00	1025P08 01	1025P08 02	1025P08 03	1025P08 04	1025P08 05	1025P08 06		0.790
10	7.5	42	1025P10 00 75	1025P10 01 75					1025P10 04 75		1.135
	8	50	1025P10 00	1025P10 01	1025P10 02	1025P10 03	1025P10 04	1025P10 05	1025P10 06		0.980
12	9	47	1025P12 00 09	1025P12 01 09					1025P12 04 09		1.345
	10	90	1025P12 00	1025P12 01				1025P12 04	1025P12 05		1.769
14	11	80	1025P14 00 11	1025P14 01 11					1025P14 04 11		1.960
	12	116	1025P14 00	1025P14 01					1025P14 04		2.226
16	13	90	1025P16 00 13	1025P16 01 13	1025P16 02 13	1025P16 03 13	1025P16 04 13				2.500

Inch version tubing available upon request

1100P Semi-Rigid Polyamide (PA) Tubing







Tubepack® 100 m

ØD ext.	ØD int.									Kg	
4	2	10	1100P04 00	1100P04 01	1100P04 02	1100P04 03	1100P04 04	1100P04 05	1100P04 06	0.893	
	2.7	10	1100P04 00 27	1100P04 01 27	1100P04 02 27	1100P04 03 27	1100P04 04 27	1100P04 05 27	1100P04 06 27	1.152	
5	3.3	15	1100P05 00 33								1.274
6	4	15	1100P06 00	1100P06 01	1100P06 02	1100P06 03	1100P06 04	1100P06 05	1100P06 06	1.799	
8	6	25	1100P08 00	1100P08 01	1100P08 02	1100P08 03	1100P08 04	1100P08 05	1100P08 06	2.560	
10	7.5	42	1100P10 00 75	1100P10 01 75			1100P10 04 75			3.430	
	8	50	1100P10 00	1100P10 01	1100P10 02	1100P10 03	1100P10 04	1100P10 05		4.000	
12	9	47	1100P12 00 09	1100P12 01 09			1100P12 04 09			5.052	
	10	90	1100P12 00	1100P12 01			1100P12 04		1100P12 06	5.600	
14	11	80	1100P14 00 11	1100P14 01 11			1100P14 04 11			4.800	
	12	116	1100P14 00	1100P14 01			1100P14 04			5.200	
16	13	90	1100P16 00 13	1100P16 01 13			1100P16 04 13			6.613	

Inch version tubing available upon request







2005P Semi-Rigid Polyamide (PA) Tubing

Drum 500 m

ØD ext.	ØD int.								Kg
8	6	25	2005P08 00	2005P08 01	2005P08 02	2005P08 03	2005P08 04	2005P08 05	12.100
10	8	50	2005P10 00	2005P10 01	2005P10 02	2005P10 03	2005P10 04	2005P10 05	15.600



2010P Semi-Rigid Polyamide (PA) Tubing

Drum 1000 m

ØD ext.	ØD int.								Kg
4	2.7	10	2010P04 00 27	2010P04 01 27	2010P04 02 27	2010P04 03 27	2010P04 04 27	2010P04 05 27	7.630
6	4	15	2010P06 00	2010P06 01	2010P06 02	2010P06 03	2010P06 04	2010P06 05	16.600

1025L Rigid Polyamide (PA) Tubing

Tubepack® 25 m

ØD ext.	ØD int.			Kg
4	2.5	35	1025L04 01 25	0.192
6	4	45	1025L06 01	0.506
8	5	70	1025L08 01 05	1.040
	6	65	1025L08 01	0.777
10	6	85	1025L10 01 06	1.248

PA tubing can be connected to various fittings shown throughout this catalogue.

Tubing

Semi-Rigid PA



Rigid PA



Push-In Fittings

LF 3000®



LF 3600



LF 3800



LF 6100



Compression Fittings

Brass



Stainless Steel



Ferrules



Fireproof High Resistance PA Tubing



The high-strength fireproof PA tube is designed to resist fire and reduce the spread of toxic fumes. It is designed for demanding embedded or industrial applications, without compromising the pressure / temperature performance of a PA tube..

Ø metric:
4 to 12 mm

Technical Characteristics

- **Compatible Fluids:** Compressed air, lubricants
Other fluids: please consult us
- **Working Pressure:** Vacuum to 50 bar
- **Working Temperature:** -40°C to +100°C
- **Component Materials:** Polyamide (63 shore D)

Reliable performance is dependent upon the type of fluid conveyed and fittings being used. Use is guaranteed with a vacuum of 755 mm Hg (99% vacuum).

Performance

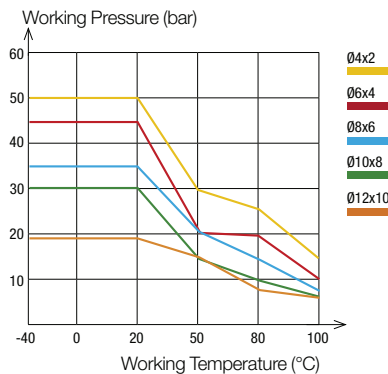

To calculate burst pressure, the values in this graph should be multiplied by 3.

Regulations

- Railway:
- EN 45545-2
- Industrial:
- PED
 - RoHS
 - REACH
 - UL94-V0 (fire resistance)

Advantages

- Resistant to UV, high pressure / high temperature
- Spark and flame resistant: self-extinguishing
- Non-toxic combustion gases, low smoke generation
- Alternative to PVC-coated PA tubing: no stripping tools, no risk of damaging tube

Tube O.D.	Tube O.D. Tolerance
4 mm	+0.05 / -0.08
6 to 12 mm	+0.05 / -0.10

Packaging
Tubepack®: 100 m

Connected to Parker Legris push-in fittings, the calibration of PA tubing ensures perfect sealing based on NF E49-100.

1100P..R Fireproof High Resistant Polyamide (PA) Tubing

Tubepack® 100 m

ØD ext.	ØD int.	ØD R	white			Kg
4	2	17	1100P04R00	1100P04R01	1100P04R04	1.308
6	4	29	1100P06R00	1100P06R01	1100P06R04	1.308
8	6	40	1100P08R00	1100P08R01	1100P08R04	2.384
10	8	77	1100P10R00	1100P10R01	1100P10R04	2.725
12	10	92	1100P12R00	1100P12R01		3.716

Other colours available on request with a minimum order quantity: for diameters 4 to 6 mm, 1000 m; for 8 mm, 500 m; for diameters 10 to 12 mm, 300 m. Extrusion constraints give an anthracite aspect to the tube but does not affect performance at all.

Related Products

Fireproof high resistance tubing can be connected to various fittings presented in the Fittings section.

Push-In Fittings

LF 3000® LF 3600 LF 3800



LF 6100



Compression Fittings

Brass Brass Tube Support



Anti-Spark PA Tubing with PVC Sheath



The PA anti-spark tubing with PVC sheath is designed to resist flames and sparks, providing superior performance against impact and abrasion. Particularly suitable for equipment in an environment subjected to welding spatter.

Ø metric:
6 to 10 mm

Technical Characteristics

- **Compatible Fluids:** Hot and cold water, refrigerated fluids, compressed air
- **Working Pressure:** 0 to 36 bar
- **Working Temperature:** -20°C to +80°C
- **Component Materials:** Polyamide & PVC sheath

Reliable performance is dependent upon the type of fluid conveyed and fittings being used.

Performance

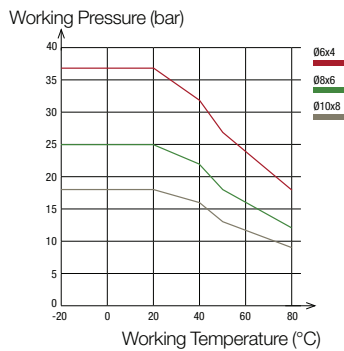

To calculate burst pressure, the values in this graph should be multiplied by 3.

Regulations

Industrial:

- **RoHS**
- **PED**
- **REACH**
- **UL94 (fire resistance)**

Advantages

- Flame retardant PVC layer protecting the inner PA tubing
- Easy stripping: the PVC layer does not adhere to the PA tubing
- Resistant to high pressure/temperature, torsion and crushing
- Compatibility with cooling liquids

O.D.	Tube O.D. Tolerance	PVC Sheath Thickness
PVC Sheath 8 to 12 mm	+0.10 / -0.10	1 mm
Inner Tubing 6 to 10 mm	+0.05 / -0.10	

Tube O.D.	Sheath Removal Length for LF 3600 Push-In Fittings (mm)
6 mm	18± 1
8 mm	19± 1
10 mm	24± 1

Connected to Parker Legris push-in fittings, the calibration of PA tubing ensures perfect sealing based on NF E49-100 (semi-rigid PA inner tubing).

For other fitting ranges, please consult us.

1025P..V Anti-Spark Polyamide (PA) Tubing

Tubepack® 25 m

ØD ext.	ØD int.	R			Kg
6	4	25			
			1025P06V01	1025P06V04	1.238
8	6	30			
			1025P08V01	1025P08V04	1.704
10	8	55			
			1025P10V01	1025P10V04	2.029

Red colour tubing are available upon request with minimum order quantity.

1100P..V Anti-Spark Polyamide (PA) Tubing

Tubepack® 100 m

ØD ext.	ØD int.	R				Kg
6	4	25				
				1100P06V02	1100P06V04	2.338
8	6	30				
			1100P08V01		1100P08V04	3.767
10	8	55				
			1100P10V01		1100P10V04	4.767

Red colour tubing are available upon request with minimum order quantity.

6000 71 00 Stripping Tool for Anti-Spark Tubing

Technical polymer, stainless steel



	Kg
6000 71 00	0.098

PU Tubing



The PU tubing is available in 3 grades of ether, ester and crystal ether. Flexible with a small bend radius, it saves 50% of space for networks, compared to the semi-rigid PA.

Ø metric:
3 to 16 mm

Technical Characteristics

- **Compatible Fluids:** Compressed air, industrial fluids (depending on the material type)
- **Working Pressure:** Vacuum to 12 bar
- **Working Temperature:** -20°C to +70°C
- **Component Materials:**
 - Polyurethane ester (52 Shore D)
 - Polyurethane ether (52 Shore D)
 - Polyurethane ether food-grade "crystal" (52 Shore D)

Reliable performance is dependent upon the type of fluid conveyed and fittings being used. Use is guaranteed with a vacuum of 755 mm Hg (99% vacuum).

Regulations

- | | |
|-------------|--------------------------------------|
| Industrial: | Food (PU ether food-grade "crystal") |
| • RoHS | • FDA |
| • PED | • 1935/2004 |
| • REACH | |

Advantages

3 material grades

- PU ester: standard pneumatic applications
- PU ether: suitable for hydrolysis; increased chemical resistance compared to PU ester
- PU ether crystal food grade: increased chemical resistance compared to PU ether
- Mechanical properties: flexible, small bending radius, vibration absorption, UV resistant

Performance

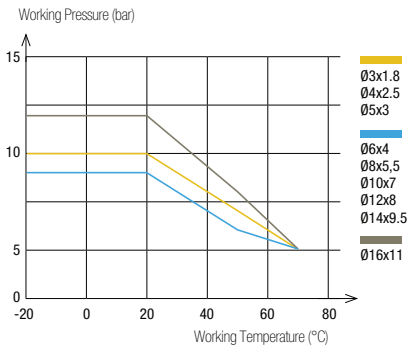

To calculate burst pressure, the values in this graph should be multiplied by 3.

Tube O.D.	Tube O.D. Tolerance
3 to 8 mm	+0.10 / -0.10
10 to 16 mm	+0.15 / -0.15

Connected to Parker Legris push-in fittings, the calibration of PU tubing ensures perfect sealing based on NF E49-101.

Packaging

Tubepack®: 25 m, 100 m
Drum: 300 m, 500 m, 1 000 m

1025U Polyurethane (PU) Ester Tubing

Tubepack® 25 m

ØD ext.	ØD int.	R							Kg
3	1.8	8	1025U03 01 18						0.131
4	2.5	10	1025U04 01	1025U04 02	1025U04 03	1025U04 04	1025U04 05	1025U04 06	0.310
5	3	13	1025U05 01			1025U05 04			0.522
6	4	15	1025U06 01	1025U06 02	1025U06 03	1025U06 04	1025U06 05	1025U06 06	0.591
8	5.5	20	1025U08 01	1025U08 02	1025U08 03	1025U08 04	1025U08 05	1025U08 06	0.971
10	7	25	1025U10 01	1025U10 02		1025U10 04	1025U10 05	1025U10 06	1.210
12	8	35	1025U12 01	1025U12 02		1025U12 04	1025U12 05	1025U12 06	2.406
14	9.5	45	1025U14 01 95			1025U14 04 95			2.815
16	11	45	1025U16 01 11	1025U16 02 11	1025U16 03 11	1025U16 04 11			2.815

Inch tubing available upon request

1100U Polyurethane (PU) Ester Tubing

Tubepack® 100 m

ØD ext.	ØD int.	R							Kg
4	2.5	10	1100U04 01	1100U04 02	1100U04 03	1100U04 04	1100U04 05	1100U04 06	1.092
5	3	13	1100U05 01			1100U05 04			1.092
6	4	15	1100U06 01	1100U06 02	1100U06 03	1100U06 04	1100U06 05	1100U06 06	2.064
8	5.5	20	1100U08 01	1100U08 02	1100U08 03	1100U08 04	1100U08 05	1100U08 06	3.200
10	7	25	1100U10 01			1100U10 04			5.200
12	8	35	1100U12 01			1100U12 04			7.464
14	9.5	45	1100U14 01 95			1100U14 04 95			10.264
16	11	45	1100U16 01 11			1100U16 04 11			12.676

Inch tubing available upon request

2003U Polyurethane (PU) Ester Tubing

Drum 300 m

ØD ext.	ØD int.							Kg
10	7	25	2003U10 01	2003U10 02	2003U10 03	2003U10 04	2003U10 06	16.600







2005U Polyurethane (PU) Ester Tubing

Drum 500 m

ØD ext.	ØD int.							Kg
8	5.5	20	2005U08 01	2005U08 02	2005U08 03	2005U08 04	2005U08 05	17.100









2010U Polyurethane (PU) Ester Tubing

Drum 1000 m

ØD ext.	ØD int.								Kg
4	2.5	12	2010U04 01	2010U04 02	2010U04 03	2010U04 04	2010U04 05	2010U04 06	9.840
6	4	15	2010U06 01	2010U06 02	2010U06 03	2010U06 04	2010U06 05	2010U06 06	20.460









1025U..R Polyurethane (PU) Ether Tubing

Tubepack® 25 m

ØD ext.	ØD int.				 Crystal					Kg
4	2.5	12	1025U04R01	1025U04R04	1025U04R08	1025U04R12	1025U04R13	1025U04R14	1025U04R17	0.310
5	3	13			1025U05R08					0.522
6	4	15	1025U06R01	1025U06R04	1025U06R08	1025U06R12	1025U06R13	1025U06R14	1025U06R17	0.591
8	5.5	20	1025U08R01	1025U08R04	1025U08R08	1025U08R12	1025U08R13	1025U08R14	1025U08R17	0.971
10	7	25	1025U10R01	1025U10R04	1025U10R08			1025U10R14		1.467
12	8	35	1025U12R01	1025U12R04	1025U12R08			1025U12R14		2.406
14	9.5	45		1025U14R04 95						2.421
16	11	45			1025U16R08 11					2.815

1100U ..R Polyurethane (PU) Ether Tubing

Tubepack® 100 m

ØD ext.	ØD int.				 Crystal					Kg
4	2.5	12	1100U04R01	1100U04R04	1100U04R08	1100U04R12	1100U04R13	1100U04R14	1100U04R17	1.092
6	4	15	1100U06R01	1100U06R04	1100U06R08	1100U06R12	1100U06R13	1100U06R14	1100U06R17	2.064
8	5.5	20	1100U08R01	1100U08R04	1100U08R08	1100U08R12	1100U08R13	1100U08R14	1100U08R17	3.610
10	7	25			1100U10R08			1100U10R14		6.109
12	8	35		1100U12R04	1100U12R08					8.610
14	9.5	45			1100U14R08 95					10.000
16	11	45			1100U16R08 11					12.176

2003U..R Polyurethane (PU) Ether Tubing

Drum 300 m

ØD ext.	ØD int.				 Crystal	Kg
10	7	25	2003U10R01	2003U10R04	2003U10R08	16.600

2005U..R Polyurethane (PU) Ether Tubing

Drum 500 m

ØD ext.	ØD int.				 Crystal	Kg
8	5.5	20	2005U08R01	2005U08R04	2005U08R08	15.600

2010U..R Polyurethane (PU) Ether Tubing

Drum 1000 m

ØD ext.	ØD int.				 Crystal	Kg
4	2.5	12			2010U04R08	8.868
6	4	15	2010U06R01	2010U06R04	2010U06R08	18.600

Antistatic PU Tubing



The antistatic PU tubing guarantees the dissipation of accumulated static electricity.

Ø metric:
3 to 12 mm

Technical Characteristics

- **Compatible Fluids:** Compressed air, industrial fluids
- **Working Pressure:** Vacuum to 10 bar
- **Working Temperature:** -20°C to +70°C
- **Component Materials:** Polyurethane with conductive additive (50 shore D)

Reliable performance is dependent upon the type of fluid conveyed and fittings being used. Use is guaranteed with a vacuum of 755 mm Hg (99% vacuum).

Performance

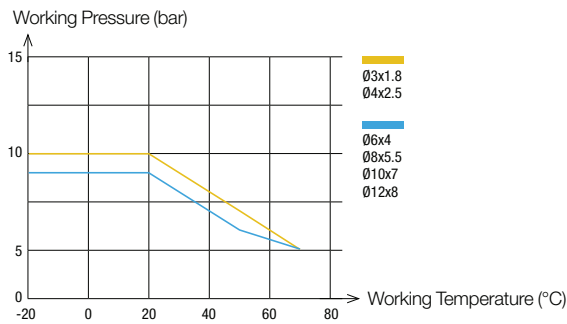

To calculate burst pressure, the values in this graph should be multiplied by 3.

Advantages

- Constant $10^2 \Omega \cdot \text{cm}$ resistivity over the wall thickness
- Good chemical resistance, UV resistance
- Minimum bending radius: maximum space saving
- ATEX zone compatibility: please contact us

Regulations

- ATEX (please consult us)
- RoHS
- REACH

Tube O.D.	Tube O.D. Tolerance
3 to 8 mm	+0.10 / -0.10
10 to 12 mm	+0.15 / -0.15

Packaging
Tubepack®: 100 m

Connected to Parker Legris push-in fittings, the calibration of Parker Legris tubing ensures perfect sealing based on NF E49-101.

1100U..A Anti-Static Polyurethane (PU) Ester Tubing

Tubepack® 100 m

ØD ext.	ØD int.	R		Kg
3	1.8	10	1100U03A01	0.836
4	2.5	12	1100U04A01	1.092
6	4	15	1100U06A01	2.064
8	5.5	25	1100U08A01	3.610
10	7	35	1100U10A01	6.105
12	8	45	1100U12A01	8.610

Related Products

To maintain the antistatic properties throughout the circuit, it is recommended that this tubing be used with metallic fittings.

Push-In Fittings

LF 3600

LF 3800



Compression Fittings

Brass

Stainless Steel



Anti-Spark PU Tubing



The anti-spark PU tubing is available in 2 versions, mainly for welding applications : PU ether single layer or PVC coated, spark resistant, without compromising flexibility.

Ø metric:
6 to 12 mm

Technical Characteristics

- **Compatible Fluids:** Industrial fluids, compressed air, coolants
- **Working Pressure:** Vacuum to 14 bar
- **Working Temperature:** -20°C to +70°C
- **Component Materials:** PU ether with PVC sheath
PU ether single layer additive (50 shore D)

Reliable performance is dependent upon the type of fluid conveyed and fittings being used. Use is guaranteed with a vacuum of 755 mm Hg (99% vacuum).

Performance

Tube O.D.	Tube O.D. Tolerance	Thickness and Tolerances of PVC Sheath
6 to 8 mm	+0.10/-0.10	1mm +0.10/-0.10
10 to 12 mm	+0.15/-0.15	

Connected to Parker Legris push-in fittings, the calibration of Parker Legris tubing ensures perfect sealing based on NF E49-101 (inner tubing for sheathed or single layer tubing).

Anti-Spark PU Tubing, with PVC Sheath

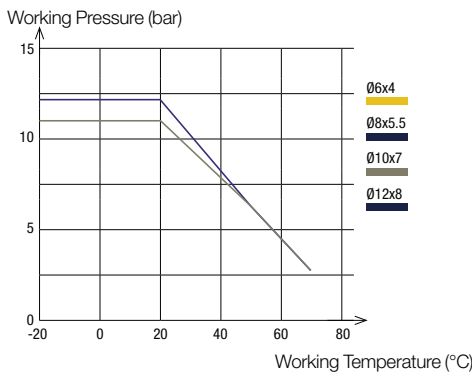

To calculate burst pressure, the values in these graphs should be multiplied by 3.

Advantages

Single-layer PU:

- Flexible for an optimized bending radius
- Flexible for a long service life at high speeds

PVC coated PU:

- Self-extinguishing PVC sheath to protect the inner tube
- Resistant to torsion, crushing

Regulations

- **UL94** (fire resistance)
- **RoHS**
- **REACH**

Anti-Spark PU Tubing, Single Layer

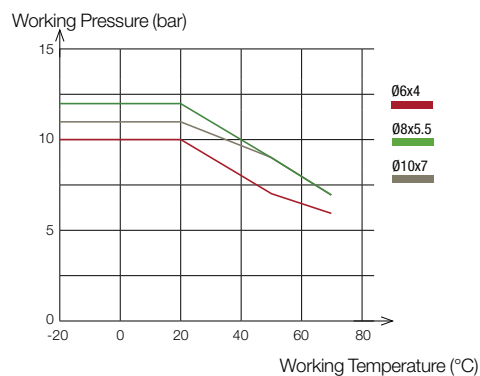

1025U..V Anti-Spark Sheath Polyurethane (PU) Ether Tubing

Tubepack® 25 m

ØD ext.	ØD int.	CR					Kg
6	4	12	1025U06V01		1025U06V03	1025U06V04	1.200
8	5.5	20	1025U08V01		1025U08V03	1025U08V04	1.620
10	7	25	1025U10V01		1025U10V03	1025U10V04	2.900
12	8	35	1025U12V01	1025U12V02	1025U12V03		4.030





1100U..V Anti-Spark Sheath Polyurethane (PU) Ether Tubing

Tubepack® 100 m

ØD ext.	ØD int.	CR			Kg
6	4	12	1100U06V01		5.370
8	5.5	20	1100U08V01	1100U08V02	7.626
10	7	25	1100U10V01		10.864





1025U..K Single Layer Anti-Spark Polyurethane (PU) Ether Tubing

Tubepack® 25 m

ØD ext.	ØD int.						Kg
6	4	15	1025U06K01	1025U06K02	1025U06K03	1025U06K04	0.580
8	5.5	20	1025U08K01	1025U08K02	1025U08K03	1025U08K04	0.860
10	7	25	1025U10K01	1025U10K02	1025U10K03	1025U10K04	1.230

1100U..K Single Layer Anti-Spark Polyurethane (PU) Ether Tubing

Tubepack® 100 m

ØD ext.	ØD int.						Kg
6	4	15	1100U06K01	1100U06K02	1100U06K03	1100U06K04	2.320
8	5.5	20	1100U08K01	1100U08K02	1100U08K03		3.030
10	7	25	1100U10K01	1100U10K02	1100U10K03	1100U10K04	5.100

6000 71 00 Stripping Tool for Anti-Spark Tubing

Technical polymer, stainless steel



	Kg
6000 71 00	0.098

Working Principle

Stripping Tool 6000 71 00



1. Place tube in stripping tool to adjust the blade height to the tube thickness.



2. Blade height is adjusted using the wheel at the bottom of the handle.

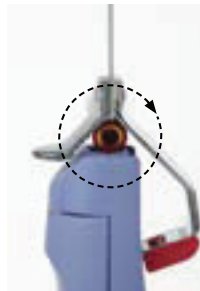

3. Once adjustments have been made, perform a 360° rotation around the tube with the tool.

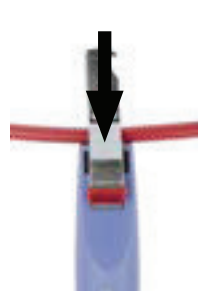

4. Push down firmly on the metal part of the tool in order to hold tube properly.



5. Move the tool to the end of the tube to create an axial opening of the sheath.



6. The tube is correctly stripped.

PE Tubing



The polyethylene tubing exists in 2 grades: low-density PE or "Advanced PE" 50% reticulated. Intended for food processing or fluid transmission applications, PE tubings are safe for users' health.

Ø metric:
4 to 16 mm

Technical Characteristics		
Tube	Advanced PE	Low Density PE
Compatible Fluids	Water, beverages and other fluids	Industrial fluids
Working Pressure	Vacuum to 16 bar	Vacuum to 20 bar
Working Temperature	-40°C to +95°C	-40°C to +60°C
Component Materials	High quality polyethylene: 50% reticulated PE 50% low density PE (53 shore D)	Low Density Polyethylene (44 shore D)

Reliable performance is dependent upon the type of fluid conveyed and fittings being used. Use is guaranteed with a vacuum of 755 mm Hg (99% vacuum).

Regulations		
Advanced PE Tubing:	<ul style="list-style-type: none"> • ACS • WRAS • KTW • W270 • PED • RoHS • DM174 	Low Density PE Tubing:
	<ul style="list-style-type: none"> • FDA: 21CFR 177.1520 • 1935/2004 • NSF 42/58 • NSF 51 • NSF 61 C-HOT 	<ul style="list-style-type: none"> • FDA: 21CFR 177.1520 • RoHS • PED

Advantages	
Advanced PE	<ul style="list-style-type: none"> • Approved for contact with beverages and food products • Resistant to a wide range of chemicals and cleaning products, stable, under UV • Excellent compromise between bending radius and pressure/temperature resistance
Low Density PE	<ul style="list-style-type: none"> • Food grade material • Resistance to corrosive and aggressive agents

Performance

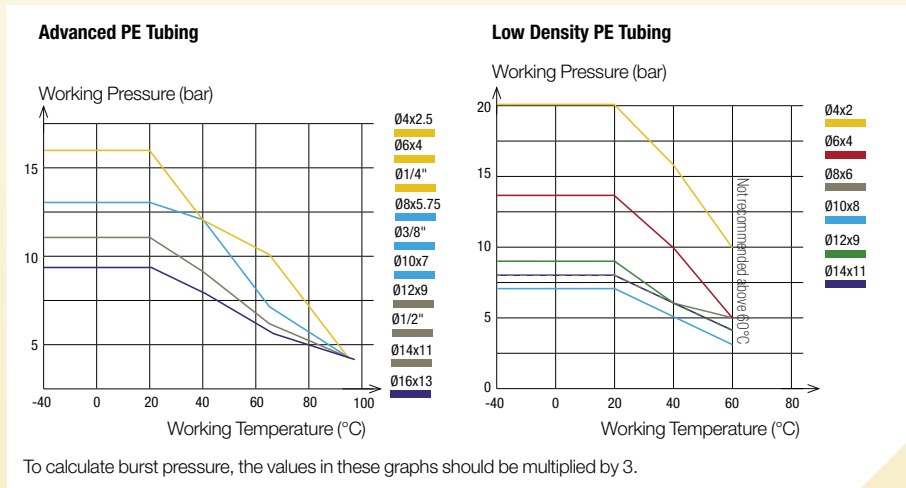

Tube O.D.	Tube O.D. Tolerance
1/4" to 1/2"	+0.10 / -0.10
4 to 16 mm	+0.10 / -0.10

Connected to Parker Legris push-in fittings, the calibration of Parker Legris tubing ensures perfect sealing.

Packaging
Advanced PE Tubing
Drum: 75 m, 150 m, 300 m, 250 feet, 500 feet
PE Tubing
Tubepack®: 100 m

1015Y..F Advanced Polyethylene (APE) Tubing

Drum 150 m

ØD ext.	ØD int.	Color	Part Number	Part Number	Part Number	Part Number	Part Number	Part Number	Part Number	Kg
6	4	clear	1015Y06F00	1015Y06F01				1015Y06F04		5.434
8	5.75	clear	1015Y08F00	1015Y08F01	1015Y08F02	1015Y08F03	1015Y08F04	1015Y08F10		3.279
10	7	clear	1015Y10F00	1015Y10F01	1015Y10F02	1015Y10F03	1015Y10F04	1015Y10F10		5.318







1030Y..F Advanced Polyethylene (APE) Tubing

Drum 300 m

ØD ext.	ØD int.	Color	Part Number	Part Number	Part Number	Part Number	Part Number	Part Number	Part Number	Kg
4	2.5	clear	1030Y04F00	1030Y04F01						2.860
6	4	clear	1030Y06F00	1030Y06F01	1030Y06F02	1030Y06F03	1030Y06F04	1030Y06F10		4.424

1075Y..F Advanced Polyethylene (APE) Tubing

Drum 75 m

ØD ext.	ØD int.		 clear					 white	Kg
12	9	55	1075Y12F00	1075Y12F01	1075Y12F02	1075Y12F03	1075Y12F04	1075Y12F10	3.852
14	11	75	1075Y14F00		1075Y14F02				5.850
16	13	90	1075Y16F00						7.750

1096Y..F Advanced Polyethylene (APE) Tubing

Drum 250 ft

ØD ext.	ØD int.		 clear			Kg
1/2	0.375	1.96	1096Y62F00	1096Y62F01	1096Y62F04	4.200



1098Y..F Advanced Polyethylene (APE) Tubing

Drum 500 ft

ØD ext.	ØD int.		 clear				Kg
1/4	0.170	0.78	1098Y56F00	1098Y56F01	1098Y56F03	1098Y56F04	2.334
3/8	0.250	1.18	1098Y60F00	1098Y60F01		1098Y60F04	5.518

1100Y Low Density Advanced Polyethylene Tubing

Tubepack® 100 m

ØD ext.	ØD int.		 clear	Kg
4	2	25	1100Y04 00	0.910
6	4	35	1100Y06 00	1.500
8	6	55	1100Y08 00	2.140
10	8	80	1100Y10 00	2.710
12	9	65	1100Y12 00	4.750
14	11	80	1100Y14 00	5.650

Fluoropolymer Tubing - FEP



The fluoropolymer FEP (fluorinated ethylene propylene) tubing offers good mechanical strength. Transparent, it allows fluid control without technical compromise.

Ø metric:
4 to 12 mm

Technical Characteristics

- **Compatible Fluids:** Industrial fluids
- **Working Pressure:** 0 to 28 bar
- **Working Temperature:** -40°C to +150°C
- **Component Materials:** Fluorinated ethylene propylene (pure) (55 Shore D)

Reliable performance is dependent upon the type of fluid conveyed and fittings being used.

Performance

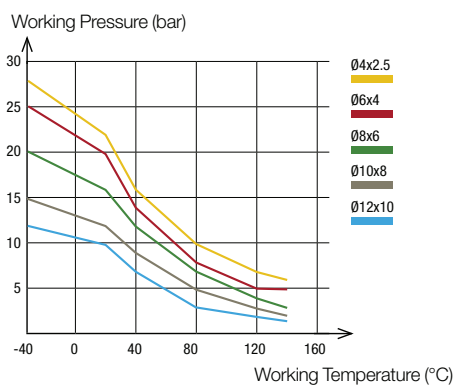

Regulations

- | | |
|--------------|----------------|
| Food: | Industrial: |
| • FDA | • RoHS |
| | • PED |
| | • REACH |

Advantages

- Flexible and non-flammable material
- FDA approval resistance to chemical agents and solvents

Tube O.D.	Tube O.D. Tolerance
4 mm	+0.05 / -0.05
6 to 10 mm	+0.07 / -0.07
12 mm	+0.10 / -0.10

Packaging

Tubepack®: 5 m, 25 m

Connected to Parker Legris push-in fittings, the calibration of Parker Legris tubing ensures perfect sealing.

1005T Fluoropolymer (FEP) Tubing

Tubepack® 5 m

ØD ext.	ØD int.	Length (m)	Part Number	Kg
4	2.5	40	1005T04 00 25	0.155
6	4	50	1005T06 00	0.250
8	6	70	1005T08 00	0.385
10	8	120	1005T10 00	0.524
12	10	180	1005T12 00	0.547

1025T Fluoropolymer (FEP) Tubing

Tubepack® 25 m

ØD ext.	ØD int.	Length (m)	Part Number	Kg
4	2.5	40	1025T04 00 25	0.506
6	4	50	1025T06 00	1.025
8	6	70	1025T08 00	1.431
10	8	120	1025T10 00	1.693
12	10	180	1025T12 00	1.913

Related Products

Parker stainless steel fittings are perfectly suited for use with fluoropolymer tubing (PFA, FEP).

Push-In Fittings

LF 3800



Compression Fittings

Stainless Steel



Fluoropolymer Tubing - PFA



The PFA (perfluoroalkoxy) tubing range is available in 3 material grades offering 10 times longer than other fluoropolymer tubing service life under severe chemical and mechanical constraints. Compatible with all applications and extreme environments.

Ø metric:
4 to 12 mm

Technical Characteristics

- **Compatible Fluids:** Medical, bio-compatible, food process, gas, compressed air
- **Working Pressure:** Vacuum to 36 bar
- **Working Temperature:** Mini -40°C
Maxi +150°C with ferrules for severe conditions of use
- **Component Materials:** Perfluoroalkoxy - 55 Shore D
 - High Purity PFA
 - Translucent coloured PFA
 - Antistatic PFA

Reliable performance is dependent upon the type of fluid conveyed and fittings being used. Use is guaranteed with a vacuum of 755 mm Hg (99% vacuum).

Performance

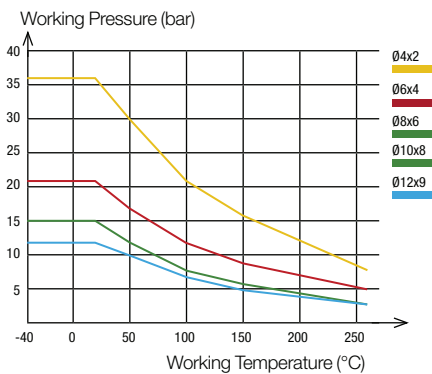

To calculate burst pressure, the values in this graph should be multiplied by 3.

Advantages

- Exceptional mechanical resistance: an alternative to stainless steel tubes
- Exceptional chemical resistance: anti-adhesive, chemical inertia, low permeability, non-flammable, UV transparent

3 material grades

- PFA high purity clear: mechanical resistance under stress
- Translucent coloured PFA: identification of circuits
- Black antistatic PFA: no electrostatic discharge

Regulations

Medical:

- USP: Class VI

Food:

- FDA
- 1935/2004

Industrial:

- ULV94
- RoHS
- PED
- REACH

Tube
O.D.

Tube O.D.
Tolerance

4 to 8 mm

+0.10/-0.10

10 to 12 mm

+0.15/-0.15

Packaging

Tubepack®: 10 m, 50 m, 100 m

Connected to Parker Legris push-in fittings, the calibration of Parker Legris tubing ensures perfect sealing based on NF E49-100.

1050T..P Fluoropolymer (PFA) Tubing

Tubepack® 50 m

ØD ext.	ØD int.	R	clear	Crystal	Crystal	Crystal	Kg
4	2	12	1050T04P00	1050T04P12	1050T04P13	1050T04P14	0.435
6	4	34	1050T06P00	1050T06P12	1050T06P13	1050T06P14	1.185
8	6	60	1050T08P00	1050T08P12	1050T08P13	1050T08P14	2.050
10	8	95	1050T10P00				3.186
12	9	120	1050T12P00				5.692

Ø 10 mm and 12 mm: green, red and blue colours are available upon request, with minimum order quantity.

1100T..P Fluoropolymer (PFA) Tubing

Tubepack® 100 m

ØD ext.	ØD int.	R	clear	Kg
6	4	34	1100T06P00	3.485
8	6	60	1100T08P00	4.805
10	8	95	1100T10P00	7.230
12	9	120	1100T12P00	11.183

1010T..A Fluoropolymer (PFA) Antistatic Tubing

Tubepack® 10 m

ØD ext.	ØD int.	R	Antistatic	Kg
4	2	12	1010T04A01	0.243
6	4	34	1010T06A01	0.392
8	6	60	1010T08A01	0.549
10	8	95	1010T10A01	0.732

Multi-Tubing



PA or PU multitubes optimize the wiring space of pneumatic circuits.

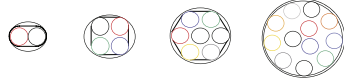

Ø metric:
4 to 8 mm

Technical Characteristics

Tube	PA	PU
Compatible Fluids	Compressed air, chemicals, industrial fluids	Compressed air, industrial fluids
Working Pressure	Vacuum to 24 bar	0 to 14 bar
Working Temperature	-40°C to +80°C	-20°C to +70°C
Component Materials	Polyamide	Polyurethane ester

Reliable performance is dependent upon the type of fluid conveyed and fittings being used. Use is guaranteed with a vacuum of 755 mm Hg (99% vacuum).

Advantages

Sheated PA Tubing

- 2 to 12 numbered tubes for circuit identification
- PVC sheathing resistant to abrasion, sparks, chemical attack
- Helically wound for a minimum bend radius

Twin PU Ester Tubing

- 3 color combinations available for circuit identification
- Tube fully joined
- Outer diameter and circular shape maintained after separation

Regulations

- RoHS
- PED
- REACH

Performance

Sheated PA Tubing

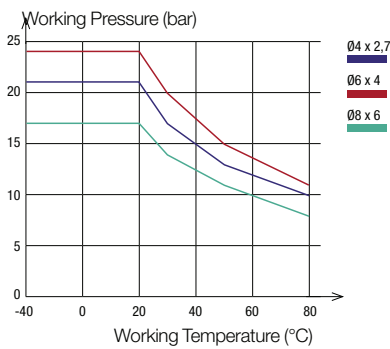

Twin PU Ester Tubing

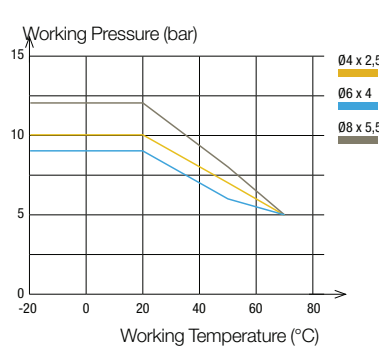

To calculate burst pressure, the values in these graphs should be multiplied by 3.

Material	Tube O.D.	Tube O.D. Tolerance
PA	4 mm	+0.05 / -0.08
	6 to 8 mm	+0.05 / -0.10
PU	4 to 8 mm	+0.10 / -0.10

Connected to Parker Legris push-in fittings, the calibration of Parker Legris tubing ensures perfect sealing based on NF E49-100 (for semi-rigid PA) and NF E49-101 (for twin PU ester).

1010P..M Semi-Rigid Polyamide (PA) Multi-Tubing

Reel 10 m

ØD ext.	ØD int.	Number of Outlets	Part Number	Kg
4	2.7	35	1010P04 00M04	1.440
	2.7	45	1010P04 00M07	1.920
6	4	55	1010P06 00M04	2.300
	4	60	1010P06 00M07	2.900
8	6	45	1010P08 00M02	2.600

1050P..M Semi-Rigid Polyamide (PA) Multi-Tubing

Reel 50 m

ØD ext.	ØD int.	Number of Outlets	Part Number	Kg
4	2.7	20	1050P04 00M02	5.450
	2.7	35	1050P04 00M04	6.600
	2.7	45	1050P04 00M07	8.200
	2.7	55	1050P04 00M12	15.200
6	4	45	1050P06 00M02	9.100
	4	55	1050P06 00M04	11.500
	4	60	1050P06 00M07	12.500
8	6	45	1050P08 00M02	13.600

1420U Twin Polyurethane (PU) Tubing

Tubepack® 25 m

ØD ext.	ØD int.	Number of Outlets	Part Number	Part Number	Part Number	Kg
4	2.5	12	1420U04 11	1420U04 41	1420U04 44	0.620
6	4	15	1420U06 11	1420U06 41	1420U06 44	1.182
8	5.5	20	1420U08 11	1420U08 41	1420U08 44	1.942

PA Recoil Tubing

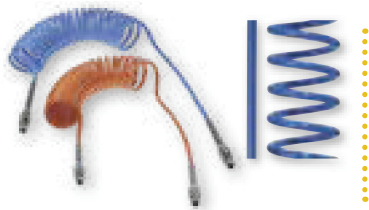

The PA recoil tubing is an alternative to reels thanks to the remanence of the recoil shape given to the PA tubing.

Legris Ø metric: 6 to 8 mm
Rectulastic Ø metric: 4.7 to 15.8 mm

Legris PA Recoil Tubing

Technical Characteristics

- **Compatible Fluids:** Compressed air, lubricants, Other fluids: please consult us
- **Working Pressure:** Vacuum to 20 bar
- **Working Temperature:** -20°C to +80°C
- **Component Materials:** Polyamide (60 Shore D)

Reliable performance is dependent upon the type of fluid conveyed and fittings being used. Use is guaranteed with a vacuum of 755 mm Hg (99% vacuum).

Advantages

- Self-retractable due to the lasting memory of shape
- Protective spring to maintain tube integrity
- 2 colours for circuit identification

Regulations

Industrial: • PED • REACH • RoHS

Performance of Parker Legris PA Recoil Tubing

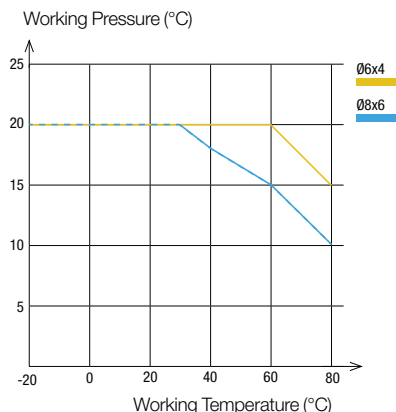

To calculate burst pressure, the values in these graphs should be multiplied by 3.

Tube O.D.	Passage	Tube O.D. Tolerance
6 mm	4 mm	+0.05/-0.10
8 mm	6 mm	+0.05/-0.10

Rectulastic PA Recoil Hose

Technical Characteristics

- **Material:** Polyamide 12
- **Compatible fluids:** Compressed air, Lubrification, grease/oil, Gasoline, Hydraulic, Vacuum, Chemicals (on request)
- **Working Pressure:** 15 bar
- **Working Temperature:** -40°C up to +90°C
- **Working Temperature for Tubing assembled:** -20°C to +70°C

Advantages

- Lightweight
- Wide temperature range
- Long service time
- Highly elasticity

Performance of Rectulastic Tubing

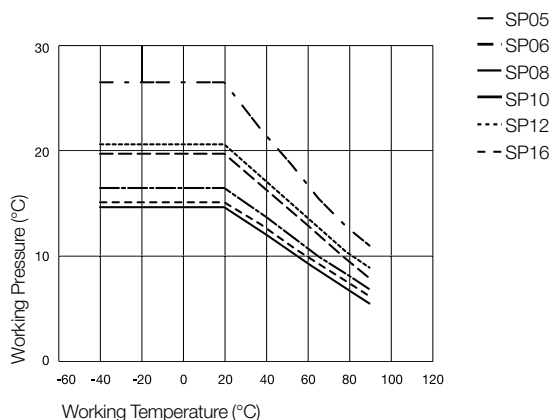

1470P Polyamide (PA) Recoil Tubing 2 m, Male BSPT Fitting

ØD ext.	ØD int.	C			Total Closed Length	O.D. of Coil	Kg
6	4	R1/4	1470P06 04 13	1470P06 07 13	520	60	0.143
8	6	R1/4	1470P08 04 13	1470P08 07 13	560	70	0.174

Length of long straight section: 300 mm
 Length of short straight section: 100 mm



1471P Polyamide (PA) Recoil Tubing 4 m, Male BSPT Fitting

ØD ext.	ØD int.	C			Total Closed Length	O.D. of Coil	Kg
6	4	R1/4	1471P06 04 13	1471P06 07 13	640	60	0.199
8	6	R1/4	1471P08 04 13	1471P08 07 13	720	70	0.249

Length of long straight section: 300 mm
 Length of short straight section: 100 mm

PA Recoil Tubing

1472P Polyamide (PA) Recoil Tubing 6 m, Male BSPT Fitting

ØD ext.	ØD int.	C			Total Closed Length	O.D. of Coil	Kg
6	4	R1/4	1472P06 04 13	1472P06 07 13	760	60	0.260
8	6	R1/4	1472P08 04 13	1472P08 07 13	880	70	0.329

Length of long straight section: 300 mm

Length of short straight section: 100 mm

SP../025 RECTULASTIC - Polyamide (PA) Coiled Hoses without Fittings 2.5 m

ØD ext.	ØD int.		O.D. of Coil
4.7	3.1	SP05/025	38
6.3	4.8	SP06/025	75
7.9	6.3	SP08/025	75
9.5	7.9	SP10/025	115
11.8	9.5	SP12/025	140

SP../050 RECTULASTIC - Polyamide (PA) Coiled Hoses without Fittings 5 m

ØD ext.	ØD int.		O.D. of Coil
4.7	3.1	SP05/050	38
6.3	4.8	SP06/050	75
7.9	6.3	SP08/050	75
9.5	7.9	SP10/050	115
11.8	9.5	SP12/050	140
15.8	12.7	SP16/050	220

SP../075 RECTULASTIC - Polyamide (PA) Coiled Hoses without Fittings 7.5 m

ØD ext.	ØD int.		O.D. of Coil
4.7	3.1	SP05/075	38
6.3	4.8	SP06/075	75
7.9	6.3	SP08/075	75
9.5	7.9	SP10/075	115
11.8	9.5	SP12/075	140
15.8	12.7	SP16/075	220

SP../100 RECTULASTIC - Polyamide (PA) Coiled Hoses without Fittings 10 m

ØD ext.	ØD int.		O.D. of Coil
4.7	3.1	SP05/100	38
6.3	4.8	SP06/100	75
7.9	6.3	SP08/100	75
9.5	7.9	SP10/100	115
11.8	9.5	SP12/100	140
15.8	12.7	SP16/100	220

SP../150 RECTULASTIC - Polyamide (PA) Coiled Hoses without Fittings 15 m

ØD ext.	ØD int.		O.D. of Coil
6.3	4.8	SP06/150	75
7.9	6.3	SP08/150	75
9.5	7.9	SP10/150	115
11.8	9.5	SP12/150	140
15.8	12.7	SP16/150	220

SP../225 RECTULASTIC - Polyamide (PA) Coiled Hoses without Fittings 22.5 m

ØD ext.	ØD int.		O.D. of Coil
6.3	4.8	SP06/225	75
7.9	6.3	SP08/225	75
9.5	7.9	SP10/225	115
11.8	9.5	SP12/225	140
15.8	12.7	SP16/225	220

SP../025/DV RECTULASTIC - Completely assembled with Swivel Fittings 2.5 m

ØD ext.	ØD int.	C		O.D. of Coil
4.7	3.1	R1/8	SP05/025/DV	38
7.9	6.3	R1/4	SP08/025/DV	75
9.5	7.9	R1/4	SP10/025/DV	115
11.8	9.5	R3/8	SP12/025/DV	140

Polyamide hose with swivel fittings and spring guards (Type DV)

SP../050/DV RECTULASTIC - Completely assembled with Swivel Fittings 5 m

ØD ext.	ØD int.	C		O.D. of Coil
4.7	3.1	R1/8	SP05/050/DV	38
7.9	6.3	R1/4	SP08/050/DV	75
9.5	7.9	R1/4	SP10/050/DV	115
11.8	9.5	R3/8	SP12/050/DV	140
15.8	12.7	R1/2	SP16/050/DV	220

Polyamide hose with swivel fittings and spring guards (Type DV)

SP../075/DV RECTULASTIC - Completely assembled with Swivel Fittings 7.5 m

ØD ext.	ØD int.	C		O.D. of Coil
4.7	3.1	R1/8	SP05/075/DV	38
7.9	6.3	R1/4	SP08/075/DV	75
9.5	7.9	R1/4	SP10/075/DV	115
11.8	9.5	R3/8	SP12/075/DV	140
15.8	12.7	R1/2	SP16/075/DV	220

Polyamide hose with swivel fittings and spring guards (Type DV)

SP../100/DV RECTULASTIC - Completely assembled with Swivel Fittings 10 m

ØD ext.	ØD int.	C		O.D. of Coil
4.7	3.1	R1/8	SP05/100/DV	38
7.9	6.3	R1/4	SP08/100/DV	75
9.5	7.9	R1/4	SP10/100/DV	115
11.8	9.5	R3/8	SP12/100/DV	140
15.8	12.7	R1/2	SP16/100/DV	220

Polyamide hose with swivel fittings and spring guards (Type DV)

SP../150/DV RECTULASTIC - Completely assembled with Swivel Fittings 15 m

ØD ext.	ØD int.	C		O.D. of Coil
7.9	6.3	R1/4	SP08/150/DV	75
9.5	7.9	R1/4	SP10/150/DV	115
11.8	9.5	R3/8	SP12/150/DV	140
15.8	12.7	R1/2	SP16/150/DV	220

Polyamide hose with swivel fittings and spring guards (Type DV)

SP../225/DV RECTULASTIC - Completely assembled with Swivel Fittings 22.5 m

ØD ext.	ØD int.	C		O.D. of Coil
7.9	6.3	R1/4	SP08/225/DV	75
9.5	7.9	R1/4	SP10/225/DV	115
11.8	9.5	R3/8	SP12/225/DV	140
15.8	12.7	R1/2	SP16/225/DV	220

Polyamide hose with swivel fittings and spring guards (Type DV)

SP../025/K+S RECTULASTIC - Completely assembled with Coupling and Plug 2.5 m

ØD ext.	ØD int.		O.D. of Coil
7.9	6.3	SP08/025/K+S	75
9.5	7.9	SP10/025/K+S	115
11.8	9.5	SP12/025/K+S	140

Polyamide hose with 26 series coupling and plug with spring guards

SP../050/K+S RECTULASTIC - Completely assembled with Coupling and Plug 5 m

ØD ext.	ØD int.		O.D. of Coil
7.9	6.3	SP08/050/K+S	75
9.5	7.9	SP10/050/K+S	115
11.8	9.5	SP12/050/K+S	140

Polyamide hose with 26 series coupling and plug with spring guards

SP../075/K+S RECTULASTIC - Completely assembled with Coupling and Plug 7.5 m

ØD ext.	ØD int.		O.D. of Coil
7.9	6.3	SP08/075/K+S	75
9.5	7.9	SP10/075/K+S	115
11.8	9.5	SP12/075/K+S	140

Polyamide hose with 26 series coupling and plug with spring guards

SP../100/K+S RECTULASTIC - Completely assembled with Coupling and Plug 10 m

ØD ext.	ØD int.		O.D. of Coil
7.9	6.3	SP08/100/K+S	75
9.5	7.9	SP10/100/K+S	115
11.8	9.5	SP12/100/K+S	140

Polyamide hose with 26 series coupling and plug with spring guards

SP../150/K+S RECTULASTIC - Completely assembled with Coupling and Plug 15 m

ØD ext.	ØD int.		O.D. of Coil
7.9	6.3	SP08/150/K+S	75
9.5	7.9	SP10/150/K+S	115
11.8	9.5	SP12/150/K+S	140

Polyamide hose with 26 series coupling and plug with spring guards

SP../225/K+S RECTULASTIC - Completely assembled with Coupling and Plug 22.5 m

ØD ext.	ØD int.		O.D. of Coil
7.9	6.3	SP08/225/K+S	75
9.5	7.9	SP10/225/K+S	115
11.8	9.5	SP12/225/K+S	140

Polyamide hose with 26 series coupling and plug with spring guards

PU Recoil Tubing

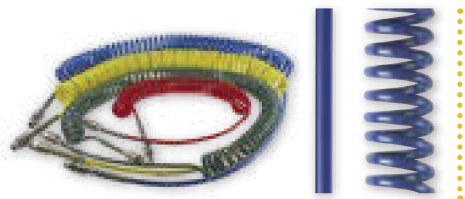

The PU recoil tubing offers an alternative to reels thanks to the remanence of the coil shape given to the PU tube. Its flexibility allows easy handling.

Legris Ø metric: 4 to 12 mm
Rectuflex Ø metric: 8 to 15 mm

Legris PU Recoil Tubing

Technical Characteristics

- **Compatible Fluids:** Compressed air
- **Working Pressure:** 0 to 10 bar
- **Working Temperature:** -20°C to +70°C (tubing assembled)
- **Component Materials:** PU ester: 52 Shore D
PU ether: 46 Shore D

Reliable performance is dependent upon the type of fluid conveyed and fittings being used.

Advantages

- 2 grades of materials: PU ester and PU ether
- With or without assembled fitting
- Self-retractable due to the shape memory of the coils
- Protective spring to maintain tube integrity
- 3 colors for circuit identification

Regulations

Industrial:

- **RoHS**
- **REACH**
- **PED**

Rectus PU Recoil Tubing: Rectuflex

Technical Characteristics

- **Compatible fluids:** Compressed air, Lubrification grease/oil, Gasoline, Hydraulics, Vacuum, Chemicals (on request), Food and Beverage (on request)
- **Working Pressure:** 10 bar
- **Working Temperature:** -40°C up to +75°C
-20°C up to +70°C (tubing assembled)
- **Component materials:** Nycoil Polyurethane

Advantages

- Lightweight and extremely durable hose
- Low pressure drop
- High abrasion resistance
- Very small bending radius and tight coil diameter
- Superior elasticity and coil memory

Performance of Legris PU Recoil Tubing

PU Ester Recoil Tubing

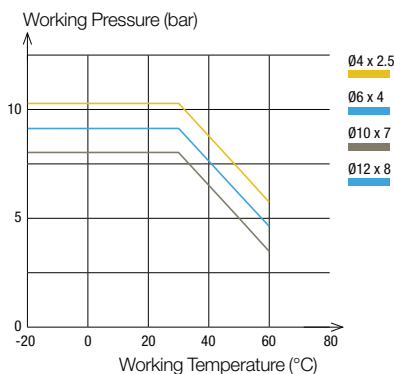

PU Ether Recoil Tubing

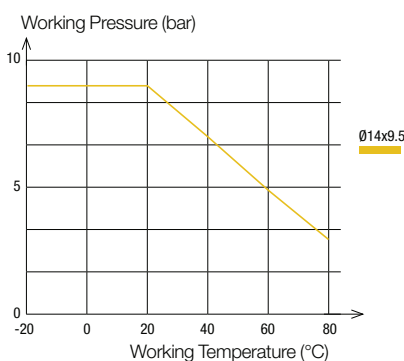

To calculate burst pressure, the values in these graphs should be multiplied by 3.



Tube O.D.	Tube I.D.	Tube O.D. Tolerance
8 mm	2.5 to 5.5 mm	+0.10 / -0.10
10 to 12 mm	7 to 8 mm	+0.15 / -0.15

1470U Polyurethane (PU) Ester Recoil Tubing 2 m, Male BSPT Fitting

ØD ext.	ØD int.	C				Total Closed Length	O.D. of Coil	Kg
4	2.5	R1/8	1470U04 03 10	1470U04 04 10	1470U04 05 10	595	24	0.060
6	4	R1/4	1470U06 03 13	1470U06 04 13	1470U06 05 13	630	32	0.060
8	5	R1/4	1470U08 03 13	1470U08 04 13	1470U08 05 13	780	45	0.120
10	7	R1/4	1470U10 03 13	1470U10 04 13	1470U10 05 13	780	65	0.160
12	8	R3/8	1470U12 03 17	1470U12 04 17	1470U12 05 17	780	75	0.190



Length of long straight section, O.D. < 8 mm: 300 mm Length of long straight section, O.D. ≥ 8 mm: 500 mm
 Length of short straight section, for all O.D.: 100 mm

1471U Polyurethane (PU) Ester Recoil Tubing 4 m, Male BSPT Fitting

ØD ext.	ØD int.	C				Total Closed Length	O.D. of Coil	Kg
4	2.5	R1/8	1471U04 03 10	1471U04 04 10	1471U04 05 10	785	24	0.100
6	4	R1/4	1471U06 03 13	1471U06 04 13	1471U06 05 13	850	32	0.160
8	5	R1/4	1471U08 03 13	1471U08 04 13	1471U08 05 13	1000	45	0.200
10	7	R1/4	1471U10 03 13	1471U10 04 13	1471U10 05 13	1000	65	0.230
12	8	R3/8	1471U12 03 17	1471U12 04 17	1471U12 05 17	1140	75	0.260

Length of long straight section, O.D. < 8 mm: 300 mm Length of long straight section, O.D. ≥ 8 mm: 500 mm
Length of short straight section, for all O.D.: 100 mm

1472U Polyurethane (PU) Ester Recoil Tubing 6 m, Male BSPT Fitting

ØD ext.	ØD int.	C				Total Closed Length	O.D. of Coil	Kg
8	5	R1/4	1472U08 03 13	1472U08 04 13	1472U08 05 13	1230	45	0.280
10	7	R1/4	1472U10 03 13	1472U10 04 13	1472U10 05 13	1140	65	0.295
12	8	R3/8	1472U12 03 17	1472U12 04 17	1472U12 05 17	1190	75	0.310

Length of long straight section, O.D. < 8 mm: 300 mm Length of long straight section, O.D. ≥ 8 mm: 500 mm
Length of short straight section, for all O.D.: 100 mm

1460U Polyurethane (PU) Ester Recoil Tubing 2 m

ØD ext.	ØD int.		Total Closed Length	O.D. of Coil	Kg
8	5	1460U08 04	720	45	0.135
10	7	1460U10 04	720	65	0.227
12	8	1460U12 04	720	75	0.282

Length of long straight section, O.D. < 8 mm: 300 mm Length of long straight section, O.D. ≥ 8 mm: 500 mm
Length of short straight section, for all O.D.: 100 mm

1461U Polyurethane (PU) Ester Recoil Tubing 4 m

ØD ext.	ØD int.		Total Closed Length	O.D. of Coil	Kg
8	5	1461U08 04	940	45	0.231
10	7	1461U10 04	940	65	0.411
12	8	1461U12 04	940	75	0.486

Length of long straight section, O.D. < 8 mm: 300 mm Length of long straight section, O.D. ≥ 8 mm: 500 mm
Length of short straight section, for all O.D.: 100 mm

1462U Polyurethane (PU) Ester Recoil Tubing 6 m

ØD ext.	ØD int.		Total Closed Length	O.D. of Coil	Kg
8	5	1462U08 04	1260	45	0.337
10	7	1462U10 04	1260	65	0.513
12	8	1462U12 04	1260	75	0.684

Length of long straight section, O.D. < 8 mm: 300 mm Length of long straight section, O.D. ≥ 8 mm: 500 mm
Length of short straight section, for all O.D.: 100 mm

1445U..R Recoil Polyurethane (PU) Ether Tubing 3 m, Male BSPP Fitting

ØD ext.	ØD int.	C		Total Closed Length	O.D. of Coil	Kg
14	9.5	G3/8	1445U14R04 17	759	110	0.460

PU../030 RECTUFLEX - Polyurethane(PU) assembled with straight extensions 3 m, Male BSPP Fitting

ØD ext.	ØD int.		O.D. of Coil
8	5	PU08/030/DV	40
9.5	6.3	PU10/030/DV	60
12	8	PU12/030/DV	80
15	9.5	PU15/030/DV	110

Completely assembled with straight extensions 508 mm and 127mm

PU../060 RECTUFLEX - Polyurethane (PU) assembled with straight extensions 6 m, Male BSPP Fitting

ØD ext.	ØD int.	C		O.D. of Coil
8	5	G1/4	PU08/060/DV	40
9.5	6.3	G1/4	PU10/060/DV	60
12	8	G3/8	PU12/060/DV	80
15	9.5	G3/8	PU15/060/DV	110

Completely assembled with straight extensions 508 mm and 127mm

PU../075 RECTUFLEX - Polyurethane (PU) assembled with straight extensions 7.5 m, Male BSPP Fitting

ØD ext.	ØD int.	C		O.D. of Coil
8	5	G1/4	PU08/075/DV	40
9.5	6.3	G1/4	PU10/075/DV	60
12	8	G3/8	PU12/075/DV	80
15	9.5	G3/8	PU15/075/DV	110

Completely assembled with straight extensions 508 mm and 127mm

0694 Push-In Fitting with Protection Spring, Male BSPP Thread

Nickel-plated Brass, NBR

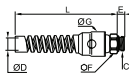

ØD	C		E	F	G	L	Kg
8	G1/4	0694 08 13	6.5	16	24	104.5	0.067
10	G1/4	0694 10 13	6.5	18	24	106.5	0.062
12	G3/8	0694 12 17	7.5	20	29.5	126	0.080

0695 Push-In Fitting with Protection Spring, Male BSPT Thread

Nickel-plated Brass, NBR

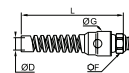

ØD	C		F	G	L	Kg
8	R1/4	0695 08 13	14	24	104.5	0.055
10	R1/4	0695 10 13	18	24	106.5	0.063
12	R3/8	0695 12 17	20	29.5	126	0.090

PVC Braided Hose



Made of industrial or food grade PVC, this braided hose covers a wide range of industrial applications for fluid transport.

Legris Ø metric: 4 to 19 mm
Rectusoft Ø metric: 11 to 19 mm

Legris PVC Braided Hose

Technical Characteristics		
Hose	Food-Grade PVC	Industrial PVC
Compatible Fluids	Compressed air, other fluids	Compressed air
Working Pressure	0 to 15 bar	0 to 15 bar
Working Temperature	-20°C to +70°C	-25°C to +60°C
Component Materials	Translucent food-grade PVC, phthalate-free with polyester braid	Industrial blue PVC, multi-layer, with polyester braid

Reliable performance is dependent upon the type of fluid conveyed and fittings being used.

Advantages

Food Grade PVC

- Monograde tube without phthalates or silicone
- Translucent to visualize fluid, turbulence, cleanliness of the circuit

Industrial PVC

- Braided reinforcement between two grades of PVC
- Mechanical resistance to abrasion, impact, crushing

Regulations

Food Grade PVC:

- FDA
- REACH
- 1935/2004
- RoHS

Industrial PVC:

- PED
- REACH
- RoHS

Rectusoft PVC Braided Hose

Technical Characteristics	
Max. Operating Pressure	15 bar, at +23°C
Working Temperature	-15°C to +60°C
Bursting Pressure	63 bar, at +23°C
Component Materials	Textile-reinforced, 3-ply PVC hose with polyester thread insert

Advantages

- Low weight
- Very high flexibility
- Highly resistant
- High resistance to pressure
- UV-resistant
- Long service life
- Shock and thread-resistant, non buckling

Performance of Legris PVC Braided Hose

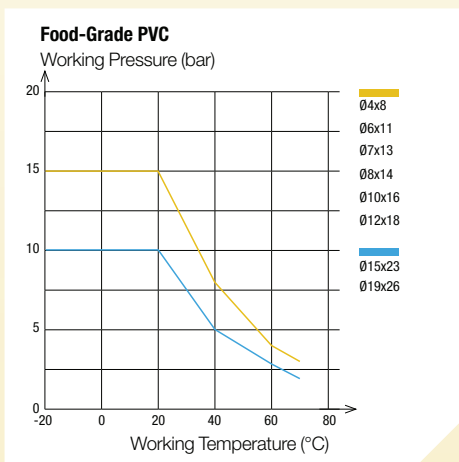

To calculate burst pressure, the values in these graphs should be multiplied by 3. The performances of the industrial PVC grade are available upon request.



Hose Type	Hose I.D.	Hose I.D. Tolerance
Food-Grade PVC	4 to 6 mm	+0.5 / -0.5
	7 to 12 mm	+0.6 / -0.6
	15 to 19 mm	+0.8 / -0.8
Industrial PVC	6.3 mm	+0.3 / -0.3
	9 mm	+0.5 / -0.5
	12.7 mm	+0.6 / -0.6

Packaging
 Reel: 25 m, 50 m
 (with protective plastic bag)

PVC Braided Hose



1025V Food-Grade Braided PVC Hose

Reel 25 m

ØD ext.	ØD int.		 clear	Kg
8	4	10	1025V08 00 04	1.260
11	6	12	1025V11 00 06	2.253
13	7	14	1025V13 00 07	3.182
14	8	16	1025V14 00 08	3.434
16	10	25	1025V16 00 10	3.800
18	12	30	1025V18 00 12	4.423
23	15	40	1025V23 00 15	7.300
26	19	60	1025V26 00 19	7.300



1050V Food-Grade Braided PVC Hose

Reel 50 m

ØD ext.	ØD int.		 clear	Kg
8	4	10	1050V08 00 04	2.690
11	6	12	1050V11 00 06	4.200
14	8	16	1050V14 00 08	6.058
16	10	25	1050V16 00 10	6.400
18	12	30	1050V18 00 12	8.250
23	15	40	1050V23 00 15	14.600
26	19	60	1050V26 00 19	14.600

1025V..C Industrial-Grade Braided PVC Hose

Reel 25 m

ØD ext.	ØD int.			Kg
11	6.3	45	1025V11C04 06	2.175
14	9	63	1025V14C04 09	3.250
19	12.7	89	1025V19C04 13	4.975

PVC../050 RECTUSOFT - Straight Hoses

Reel 50 m

ØD ext.	ØD int.		O.D. of Coil
11	6.3	PVC06/050/03	45
14.5	9	PVC09/050/03	63
19	12.7	PVC12/050/03	89

Related Products

PVC tubing is designed for use with Parker barb connectors and couplers.

Couplers

C 9000



Metal



Barb Connectors

0191



0123



Self-Fastening NBR Hose



Designed according to CNOMO E07.21.115N* standard for automotive process applications, the self-tightening hose is used with barb connectors.

Legris Ø metric: 13 to 27 mm

Legris Self-Fastening NBR Hose

Technical Characteristics

- **Compatible Fluids:** Coolants, compressed air
- **Working Pressure:** 0 to 16 bar
- **Working Temperature:** -20°C to +100°C
- **Component Materials:** Nitrile butadiene rubber & textile braid

Reliable performance is dependent upon the type of fluid conveyed and fittings being used.

Regulations

- REACH
- PED
- RoHS

Advantages

- Designed for compressed air and cooling systems, with maximum flow rate
- 4 colours for circuit identification
- Chemical resistance: UV and ozone
- Mechanical resistance: to repetitive flexing, flames and sparks, abrasion and crushing

*CAUTION: CNOMO certification is valid exclusively for red and green hose, only when connected to Legris' CNOMO-certified barb connectors 0132, 0133 and 0134.

Performance of Legris Self-Fastening NBR Hose

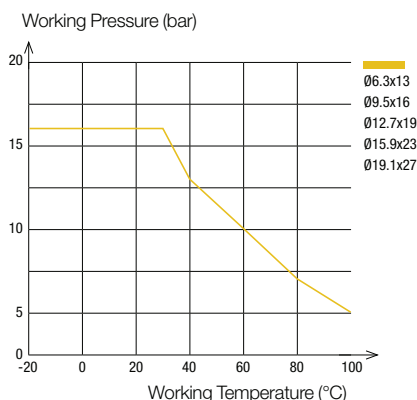

To calculate burst pressure, the values in this graph should be multiplied by 3.

DN mm CNOMO	DN (standard)	Hose I.D. (mm)	Hose I.D. Tolerance (mm)
6	1/4"	6.3 mm	+0.4/-0.4
8	3/8"	9.5 mm	+0.5/-0.5
12	1/2"	12.7 mm	+0.6/-0.6
16	5/8"	15.9 mm	
20	3/4"	19.1 mm	

Packaging
Drum: 40 m, 80 m, 100 m

Use with water: maximum temperature 100°C
Use with air: maximum temperature 70°C

1040H Braided Self-Fastening NBR Hose

Drum 40 m

DN	ØD ext.	ØD int.	Length (m)	1040H56 01	1040H56 02	1040H56 03	1040H56 04	Kg
6	13	6.3	60					7.000
8	16	9.5	70					8.500
12	19	12.7	120					10.000
16	23	15.9	140					12.000
20	27	19.1	170					17.500

Also available in 20 m length upon request

1080H Braided Self-Fastening NBR Hose

Drum 80 m





DN	ØD ext.	ØD int.	Length (m)	1080H66 01	1080H66 02	1080H66 03	1080H66 04	Kg
16	23	15.9	140					26.160
20	27	19.1	170					33.160

Also available in 20 m length upon request

Self-Fastening NBR Hose

1100H Braided Self-Fastening NBR Hose

Drum 100 m

DN	ØD ext.	ØD int.						Kg
6	13	6.3	60		1100H56 02	1100H56 03	1100H56 04	14.660
8	16	9.5	70	1100H60 01	1100H60 02	1100H60 03	1100H60 04	20.000
12	19	12.7	120	1100H62 01	1100H62 02	1100H62 03	1100H62 04	23.000

Also available in 20 m length upon request

Related Products

Self-fastening hose is designed for use with Parker brass barb connectors (CNOMO-certified) or with hose barb couplers.

Barb Connectors



Mold Couplers



Installation Tool

Tool Part Number:
0650 00 00 05

This automatic installation tool reduces the effort required to connect self-fastening hose onto a barb connector.



Tube Cutting and Positioning

Cut the tube at a right angle and position the barb connector on the mounting tool.

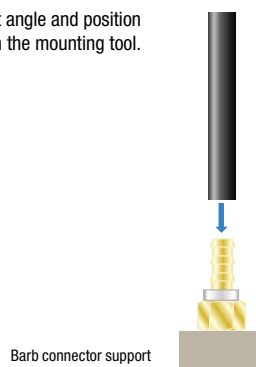

Press-Fitting the Tube

Activate the press-fit tool; connection is complete when the tube is fully home on the barb connector. This tool has been designed for use with 5 different diameters and is easy to operate.

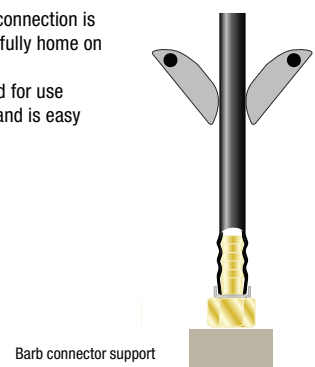

Braided PU Hose

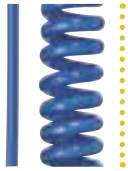
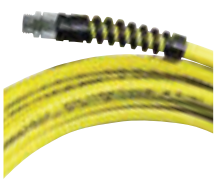

Reinforced by a braid that provides durability and torsion resistance, the braided PVC hose also retains the attributes of a recoil PU tubing.

Legris Ø inch: 1/4" to 5/16"
Superbraid Ø metric: 9.5 to 12 mm

Braided PU Recoil Hose

Technical Characteristics

- **Compatible Fluids:** Compressed air
Other fluids: please consult us
- **Working Pressure:** 0 to 15 bar
- **Working Temperature:** -40°C to +75°C
- **Component Materials:** Polyurethane (85 shore A)

Reliable performance is dependent upon the type of fluid conveyed and fittings being used.

Advantages

- 3 lengths available: 3 m, 6 m and 7.5 m
- Mechanical resistance: abrasion, torsion and crushing
- Remanence of the coils combined with the flexibility of the tube

Regulations

Industrial:

- PED
- REACH
- RoHS

Tubing Performance of Braided PU Recoil Hose

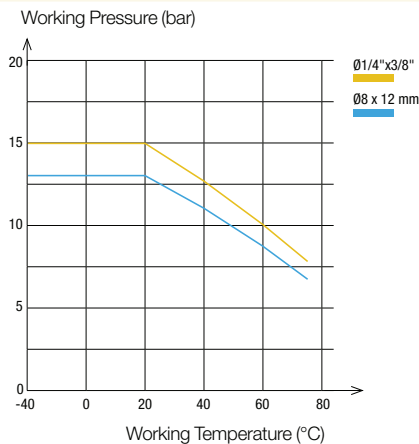

To calculate burst pressure, the values in this graph should be multiplied by 4.

Hose O.D. Hose I.D. Hose I.D. Tolerance

3/8" 1/4" +/- 0.005"
12 mm 8 mm

Connected to Parker Legris push-in fittings, the calibration of PU tubing ensures perfect sealing.

Rectus Ultra Lite Superbraid

Technical Characteristics

- **Working Pressure:** 0 to 12 bar
- **Working Temperature:** -40°C to +75°C
- **Component Materials:** Polyurethane



Advantages

- Highly kinking resistant, virtually undamaged by twisting or crushing
- Extremely flexible
- Lighter than Superbraid Hose
- 6 to 10 times better than rubber or polyamide

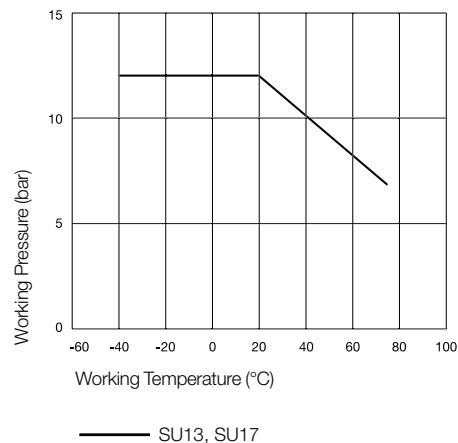
Tubing Performance of Ultra Lite Superbraid





PG../30 SUPERBRAID - Polyurethane (PU) Coiled Hoses with fabric lining 3 m, Male BSPP Fitting

ØD ext.	ØD int.	C			Total Closed Length	O.D. of Coil	Kg
3/8	1/4	G1/4	PG10/030/DV			42	
12	8	G3/8	PG12/030/DV	1445U12E04 17	880	55	0.300



fully assembled with 2x nickel-plated, swivel screw connections

PG../60 SUPERBRAID - Polyurethane (PU) Coiled Hoses with fabric lining 6 m, Male BSPP Fitting

ØD ext.	ØD int.	C			Total Closed Length	O.D. of Coil	Kg
3/8	1/4	G1/4	PG10/060/DV	1442U60E04 13	1140	42	0.420
12	8	G3/8	PG12/060/DV	1442U12E04 17	1160	55	0.600

fully assembled with 2x nickel-plated, swivel screw connections

PG../75 SUPERBRAID - Polyurethane (PU) Coiled Hoses with fabric lining 7.5 m, Male BSPP Fitting

ØD ext.	ØD int.	C			Total Closed Length	O.D. of Coil	Kg
3/8	1/4	G1/4	PG10/075/DV	1447U60E04 13	1275	42	0.525
12	8	G3/8	PG12/075/DV	1447U12E04 17	1300	55	0.750

fully assembled with 2x nickel-plated, swivel screw connections

SU../25 ULTRA-LITE SUPERBRAID - Polyurethane (PU) Straight Hose 25 m

ØD ext.	ØD int.	
13	9.5	SU13/025/05
17.4	12.7	SU17/025/05

3000 71 00 Tube Cutter

Technical polymer

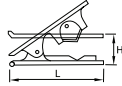

H L Kg

3000 71 00	25	79	0.029
------------	----	----	-------

This tool is designed to give a clean cut at right angles to the tube axis for all resilient polymer tubing (polyamide, polyurethane, FEP, polyethylene, etc.) from 4 mm to 16 mm diameter inclusive.

Replacement blades: part number 3000 71 00 05
A spring maintains the cutter in the closed position.

3000 71 11 Tube Cutter

Treated steel



Kg

3000 71 11	0.280
------------	-------

Replacement blades: part number 3000 71 11 05

6000 71 00 Stripping Tool for Anti-Spark Tubing

Polymère technique, acier inox



Kg

6000 71 00	0.098
------------	-------

1827 Stainless Steel Tube Support for Fluoropolymer Tubing

Stainless steel 316L

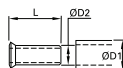

ØD1	ØD2	L	Kg
-----	-----	---	----

6	4	1827 06 00	11.5	0.001
8	6	1827 08 00	14	0.001
10	8	1827 10 00	18	0.001
12	9	1827 12 09	18	0.001
12	10	1827 12 00	18	0.001
16	13	1827 16 13	18	0.002
16	14	1827 16 00	18	0.002

This tube support is necessary when using fluoropolymer tubing at all temperatures compatible with the fitting/tubing assembly.

0127 Brass Tube Support for Polymer Tubing

Brass

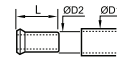

ØD1	ØD2	L	Kg	
4	2	0127 04 00	11	0.001
4	2.7	0127 04 27	11	0.001
5	3	0127 05 03	11	0.001
5	3.3	0127 05 00	11.5	0.001
6	4	0127 06 00	11.5	0.001
8	5.5	0127 08 55	14	0.001
8	6	0127 08 00	14	0.001
10	7	0127 10 07	18	0.001
10	7.5	0127 10 75	18	0.001
10	8	0127 10 00	18	0.002
12	8	0127 12 08	26	0.002
12	9	0127 12 09	18	0.002
12	10	0127 12 00	18	0.001
14	11	0127 14 11	16	0.002
14	12	0127 14 00	18	0.002
15	12	0127 15 12	18	0.002
16	13	0127 16 13	18	0.003
18	14	0127 18 14	19.5	0.003
22	16	0127 22 16	21	0.005

This tube support guarantees good gripping, at high temperatures and pressures, by preventing collapsing of the tube.

CLIP Clip Strip for Tubing and Fittings

Technical polymer

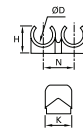

ØD	H	K	N	K	Kg	
4	CLIP 04 00	9	13.5	10.5	13.5	0.007
6	CLIP 06 00	10.5	13	10.5	13	0.008
8	CLIP 08 00	12.5	10.5	12	10.5	0.007
10	CLIP 10 00	14	12	15	12	0.005
12	CLIP 12 00	16.5	14	16.5	14	0.009
14	CLIP 14 00	18	16	20.5	16	0.009

Delivered in boxes of 10 strips of the same diameter (complete with self-tapping screws of 95 mm length) These clips can be used with metric or inch tubing.

0697 Clip for Braided Tubing

Treated steel

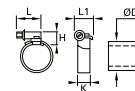

ØD	H	K	L	L1	K	Kg	
6-11	0697 00 01	7	5	12	7	5	0.004
10-16	0697 00 02	12	9	21	13	9	0.011
12-22	0697 00 03	12	9	21	13	9	0.014
16-27	0697 00 04	12	9	24	13	9	0.015
20-32	0697 00 05	12	9	24	13	9	0.016

UR Threaded Nut

Brass



C	UR	HEX	L
G1/8 right	UR10	12	11
G1/4 right	UR13	17	15.5
G3/8 right	UR17	19	16.5
G1/4 r.f. 9 mm	UR13/9*	17	15.5
G1/2 right	UR21	24	20.5

DIN EN 560 (left handed thread marked)
* only for STP13/09

STP Hose Tail, short

Brass



ØD	C	STP	L
4	G1/8	STP10/04	27.5
6	G1/8	STP10/06	28
4	G1/4	STP13/04	30.5
6	G1/4	STP13/06	35.5
9	G1/4	STP13/09*	35.5
6	G3/8	STP17/06	36
9	G3/8	STP17/09	36
	G1/2	STP21/09	38
13	G1/2	STP21/13	44

STD Hose Tail, long

Brass



ØD	C	STD	L
4	G1/4	STD13/04	47
6	G1/4	STD13/06	47
4	G3/8	STD17/04	47.5
6	G3/8	STD17/06	47.5
9	G3/8	STD17/09	47.5

DIN EN 560

GT Hose Tail Barb

Brass



ØD	C	GT	HEX	L
3	M5	GT05/03	7	15.5
	M5	GT05/04	7	15.5
4	M6	GT06/04	8	23
6	G1/2*	GT21/06	24	39
4	G1/8*	GT10/04	14	28
6	G1/8*	GT10/06	14	33
8	G1/8*	GT10/08	14	33
9	G1/8*	GT10/09	14	33
4	G1/4*	GT13/04	17	29.5
6	G1/4*	GT13/06	17	34.5
8	G1/4*	GT13/08	17	34.5
9	G1/4*	GT13/09	17	34.5
10	G1/4*	GT13/10	17	34.5
3	G1/4*	GT13/13	17	41.5
6	G3/8*	GT17/06	19	36
8	G3/8*	GT17/08	19	36
9	G3/8*	GT17/09	19	36
10	G3/8*	GT17/10	19	36
13	G3/8*	GT17/13	19	42
9	G1/2*	GT21/09	24	39
10	G1/2	GT21/10	24	40
13	G1/2*	GT21/13	24	45
16	G1/2	GT21/16	24	53
19	G1/2	GT21/19	24	54
13	G3/4*	GT26/13	32	48.5
16	G3/4*	GT26/16	32	56.5
19	G3/4*	GT26/19	32	56.5
25	G1*	GT33/25	36	67.5

with Male Thread
(* inner cone 45°)

GT Hose Tail Barb

Stainless steel



ØD	C	GT	HEX	L	Version
6	G1/8*	GT10/06R	14	33	AISI 303
	G1/8*	GT10/06E	14	33	AISI 316L
9	G1/4*	GT13/09R	17	34.5	AISI 303
	G3/8*	GT17/09R	19	36	AISI 303
13	G1/2*	GT21/13R	24	45	AISI 303

with Male Thread (* inner cone 45°)

GI Hose Tail Barb

Brass



ØD	C		HEX	L
6	G1/8	GI10/06	12	31
8	G1/8	GI10/08	12	31
6	G1/4	GI13/06	17	33
8	G1/4	GI13/08	17	33
9	G1/4	GI13/09	17	33
13	G1/4	GI13/13	17	39
6	G3/8	GI17/06	19	33
8	G3/8	GI17/08	19	33
9	G3/8	GI17/09	19	33
13	G3/8	GI17/13	19	40
6	G1/2	GI21/06	24	36
8	G1/2	GI21/08	24	36
9	G1/2	GI21/09	24	36
13	G1/2	GI21/13	24	43

with Female Thread

DS Hose Repairer

Brass



ØD		L
4	DS04/04P**	50
6	DS06/06*	72
8	DS08/08*	72
9	DS09/09*	72
13	DS13/13	74

* DIN EN 560

** for Hard Hoses

DK Hose Repairer, short

Brass



ØD		L
4	DK04/04	19
6	DK06/06	19

SM Tube Nut for Plastic Hoses

Brass



ØD	C		HEX	L
3 x 4	M7x0.5	SM04	-	8.5
3 x 5	M7x0.6	SM05	-	8.5
4 x 6	M10x1	SM06	12	11
6 x 8	M12x1	SM08	14	11
8 x 10	M16x1	SM10	17	12.5
9 x 12	M16x1	SM12	17	12.5

DV Swivelling Spring Guard

Brass



ØD	C		HEX
3.1 x 4.7	R1/8	DV10/05	11
4.8 x 6.3	R1/4	DV13/06	14
6.3 x 7.9	R1/4	DV13/08	14
7.9 x 9.5	R1/4	DV13/10	15
9.5 x 11.8	R3/8	DV17/12	19
12.7 x 15.8	R1/2	DV21/16	22

SV Fixed Spring Guard

Brass



ØD	C		HEX	L
4 x 6	G1/8	SV10/06	12	103
6 x 8	G1/8	SV10/08	12	106
4 x 6	G1/4	SV13/06	17	103
6 x 8	G1/4	SV13/08	17	106
8 x 10	G1/4	SV13/10	17	119
9 x 12	G1/4	SV13/12	17	123
	G3/8	SV17/12*	19	123

* Inner Cone 45°

KN Spring Guard completely with Tube Nut

Brass



ØD	C		HEX	L
4 x 6	M10x1	KN06	12	94
6 x 8	M12x1	KN08	14	97
8 x 10	M16x1	KN10	17	110
9 x 12	M16x1	KN12	17	114

0694 Push-In Fitting with Protection Spring, Male BSPP Thread

Nickel-plated Brass, NBR

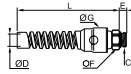

ØD	C		E	F	G	L	Kg
8	G1/4	0694 08 13	6.5	16	24	104.5	0.067
10	G1/4	0694 10 13	6.5	18	24	106.5	0.062
12	G3/8	0694 12 17	7.5	20	29.5	126	0.080

0695 Push-In Fitting with Protection Spring, Male BSPT Thread

Nickel-plated Brass, NBR

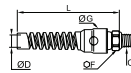

ØD	C		F	G	L	Kg
8	R1/4	0695 08 13	14	24	104.5	0.055
10	R1/4	0695 10 13	18	24	106.5	0.063
12	R3/8	0695 12 17	20	29.5	126	0.090

KB ,O'-Clips



	Spread mm	Height
KB0709	7 - 9	7
KB0911	9 - 11	7
KB1113	11 - 13	7
KB1315	13 - 15	7.5
KB1518	15 - 18	8
KB1720	17 - 20	8.5
KB2023	20 - 23	9



BLOWGUNS

Blowgun Range

	Materials	Fluids	Maximum Pressure (bar)	Temperature		Characteristics	Page
				Min.	Max.		
Industrial Blowguns							
<p>Polymer</p> 	Technical polymer	Compressed air	10	-20°C	+50°C	OSHA	428
<p>Blowguns with special features</p> 	Technical polymer, Nickel-plated brass	Compressed air	10	-20°C	+50°C	Safety, SUVA safety, Energy saving, OSHA	429
<p>Nozzles</p> 	Nickel-plated brass	Compressed air	10	-15°C	+50°C	A large number of nozzles for all your applications	430
<p>Metal</p> 	Aluminium or nickel-plated brass	Industrial fluids	20	-20°C	+100°C	Robustness, lightweight & ergonomic	432
<p>Blowgun Kits</p> 	Technical polymer	Compressed air	10	-20°C	+50°C	Easy to use, ready for use/safety & performance	434

Standard Blowguns



4 ranges of blowguns to adapt to basic, standard, safety and energy saving applications. Assembled or in kit form to offer flexibility, in technical or metallic polymers, they can meet all needs.

Technical Characteristics

- **Compatible Fluids:** Compressed air
Other fluids: contact us
- **Working Pressure:** 0 to 10 bar
- **Working Temperature:** Air: -15°C to +50°C
Dry air: -20°C to +80°C
- **Tubes:** Tubes and hoses

Advantages

Basic & standard blowguns:

- In compliance with international noise and pressure regulations
- Swivel nozzles for directional jet
- Progressive flow rate

Safety blowguns:

- Meets OSHA and SUVA standards according to model and complies with:
 - noise exposure requirements
 - provisions relating to outlet pressure
- Energy-saving blowguns:
- Limited flow for lower energy consumption
- Kits and nozzles: to ensure a suitable product

Component Materials

Silicone-free

Body:
technical polymer

Connection:
nickel-plated
brass



Nozzle:
• aluminium
(Standard blowgun)
• nickel-plated brass
(Safety and
other blowguns)

Trigger:
technical polymer

Regulations

• PED

• RoHS

• REACH

Protection of design:

All designs and models of Parker Legris blowguns have been registered with the following numbers:

- 13 224/13 225/13 226

• OSHA

• DI: 2003/10/CE

Regulation relating to exposure to noise, particularly with regard to risks to hearing. The noise level must be less than 87 dBA

Operation: Safety Blowgun



Flow stopped completely and pressure reduced to 0.5 bar

Operation: Blowgun with Safety Nozzle



Flow diverted and pressure reduced to 0.5 bar



Maximum Flow Rate
(tolerance +/-10%)



Noise Level
ISO 15744



Diffusion
Cone



Compliance
with Standards

Standard Blowguns

AK13 Blowgun with aluminium extension tube fixed nozzle



A

Female Thread G1/4 **AK13**
nozzle, impossible to replace

AM13 Blowgun without nozzle, Female BSPP Thread

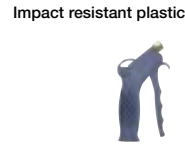

C **C1**

G1/4 M12x1.25 **AM13**

AK13SE AK13-Set in Display Box



A

Female Thread G1/4 **AK13SET**
10x AK13 in display box

AJ13 Blowgun with aluminium extension tube, Female BSPP Thread

Red impact resistant plastic



C

		Extension tube
G1/4	AJ13/06B	6 mm bent
G1/4	AJ13/08B	8 mm bent
G1/4	AJ13-300	8 x 300 mm straight
G1/4	AJ13-500	8 x 500 mm straight
G1/4	AJ13-1000	8 x 1000 mm straight

AK26SF Blowgun with aluminium extension tube fixed nozzle

Impact resistant plastic



A

Plug Series 26 **AK26SF**

0659 Standard Blowgun, Lower Connection with Short Angled Nozzle, Female BSPP Thread

Technical polymer, Nickel-plated brass, treated aluminium, NBR

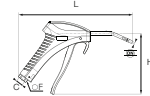

DN	C		F	H	L	Kg
3.5	G1/4	0659 00 13	20	120	223	0.108

Nozzle: aluminium

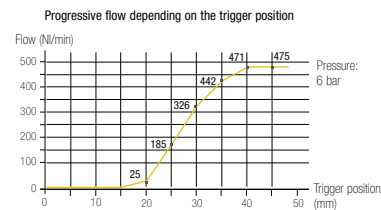

- 475 Nl/min
- 82 dBA
- OSHA 1910.242 (b)
OSHA 1910.95 (b)
2003/10/EC directive:
Requirement to use ear protection
if exposure > 8 hours

0654 Safety Blowgun, Lower Connection, Female BSPP Thread

Technical polymer, Nickel-plated brass, NBR

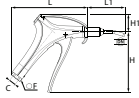

DN	C	F	H	H1	L	L1	Kg	
3	G1/4	0654 00 13	20	117	35	148	73	0.189

Nozzle: nickel-plated brass, NPT version available.

Progressive flow depending on the trigger position

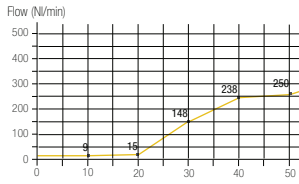

- Pressure: 6 bar
- 250 N/min
- 80 dBA
- OSHA 1910.242 (b)
OSHA 1910.95 (b)
2003/10/EC directive:
No ear defenders necessary

0654 SUVA Safety Blowgun, Lower Connection, Female BSPP Thread

Technical polymer, nickel-plated brass, NBR

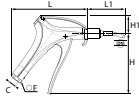

DN	C	F	H	H1	L	L1	Kg	
3	G1/4	0654 01 13	20	117	35	148	73	0.189

Nozzle: nickel-plated brass, NPT version available.

Progressive flow depending on the trigger position

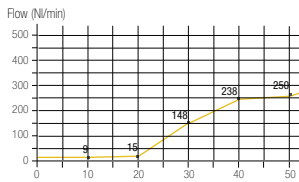

- Pressure: 6 bar
- 250 N/min
- 80 dBA
- OSHA 1910.242 (b)
OSHA 1910.95 (b)
2003/10/EC directive:
No ear defenders necessary

0653 Energy Saving Blowgun, Lower Connection with Interchangeable Nozzle, Female BSPP Thread

Technical polymer, Nickel-plated brass, NBR

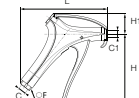

C	C1	F	H	H1	L	Kg	
G1/4	M12x1.25	0653 66 13	20	117	34	147	0.144

Flow characteristics depend on the type of nozzle used, delivered without nozzle. An energy saving calculator is available.

Progressive flow depending on the trigger position

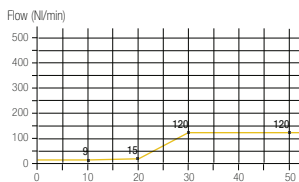

- Pressure: 6 bar
- 120 N/min
- 80 dBA
- Whatever the type of nozzle
- Noise level measured without nozzle
- OSHA 1910.242 (b):
Depends on type of nozzle
OSHA 1910.95 (b)
2003/10/EC directive:
No ear defenders necessary

0652 Progressive Control Blowgun, Lower Connection with Interchangeable Nozzle, Female BSPP Thread

Technical polymer, Nickel-plated brass, NBR

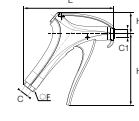

C	C1	F	H	H1	L	Kg	
G1/4	M12x1.25	0652 66 13	20	117	34	147	0.163

Flow characteristics depend on the type of nozzle used. Delivered without nozzle.

- Pressure: 6 bar
- 86 dBA
- Depending on the type of nozzle
- Noise level measured without nozzle
- OSHA 1910.242 (b):
Depends on type of nozzle
OSHA 1910.95 (b)
2003/10/EC directive:
Requirement to use ear protection if exposure > 8 hours

0651 Progressive Control Blowgun, Lower Connection with Standard Nozzle, Female BSPP Thread

Technical polymer, Nickel-plated brass, NBR

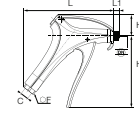

DN	C	F	H	H1	L	L1	Kg	
2.5	G1/4	0651 66 13	20	117	34	147	10	0.168

Nozzle: nickel-plated brass

Progressive flow depending on the trigger position

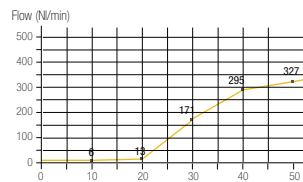

- Pressure: 6 bar
- 327 N/min
- 86 dBA
- Flow produced with nozzle 0690 01 00
- OSHA 1910.95 (b)
2003/10/EC directive:
Requirement to use ear protection if exposure > 8 hours

0656 Progressive Control Blowgun, Lower Connection with Short Angled Nozzle, Female BSPP Thread

Technical polymer, Nickel-plated brass, NBR

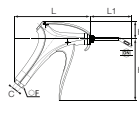

DN	C	F	H	H1	L	L1	Kg	
2.5	G1/4	0656 66 13	20	117	34	147	81	0.173

Nozzle: nickel-plated brass

Progressive flow depending on the trigger position

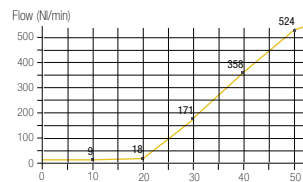

- Pressure: 6 bar
- 524 N/min
- 86 dBA
- Flow produced with nozzle 0690 06 01
- OSHA 1910.242 (b)
OSHA 1910.95 (b)
2003/10/EC directive:
Requirement to use ear protection if exposure > 8 hours

Nozzles for Polymer Blowguns

0690 01 Standard Nozzle

Nickel-plated brass

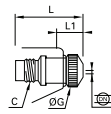

DN	C		G	L	L1	Kg
2.5	M12x1.25		15	31	9	0.023



327 N/min

86 dBA

23°

- Versatile use
- Progressive and powerful air jet

OSHA 1910.95 (b)
2003/10/EC directive:
Requirement to use ear protection
if exposure > 8 hours

0690 04 Safety Straight Nozzle (Short)

Nickel-plated brass, NBR

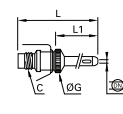

DN	C		G	L	L1	Kg
2.5	M12x1.25		15	102	77	0.034



410 N/min

82 dBA

21°

- Restricted access
- Air screen effect and directional jet
- Safety: avoids the nozzle becoming completely blocked

OSHA 1910.242 (b)/ OSHA 1910.95 (b)
2003/10/EC directive:
Requirement to use ear protection
if exposure > 8 hours

0690 02 Safety Nozzle

Nickel-plated brass

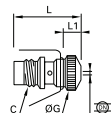

DN	C		G	L	L1	Kg
2.5	M12x1.25		15	31	9	0.024



315 N/min

83 dBA

26°

- Fluidised Powders
- Air screen effect
- Safety: avoids the nozzle becoming completely blocked

OSHA 1910.95 (b)/1910.242 (b)
2003/10/EC directive:
Requirement to use ear protection
if exposure > 8 hours

0690 05 Angled Nozzle (Long)

Nickel-plated brass, NBR

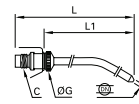

DN	C		G	L	L1	Kg
2.5	M12x1.25		15	316	292	0.065



354 N/min

82 dBA

21°

- Restricted or distant access
- Progressive and powerful air jet
- 360° rotation

OSHA 1910.95 (b)
2003/10/EC directive:
Requirement to use ear protection
if exposure > 8 hours

0690 03 Straight Nozzle (Long)

Nickel-plated brass, NBR

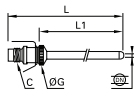

DN	C		G	L	L1	Kg
2.5	M12x1.25		15	332	307	0.067



386 N/min

82 dBA

21°

- Restricted access
- Progressive and powerful air jet

OSHA 1910.95 (b)
2003/10/EC directive:
Requirement to use ear protection
if exposure > 8 hours

0690 06 Safety Angled Nozzle (Short)

Nickel-plated brass, NBR

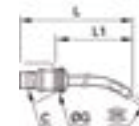

DN	C		G	L	L1	Kg
2.5	M12x1.25		15	94	70	0.033



350 N/min

86 dBA

21°

- Restricted access
- Air screen effect and 360° directional jet
- Safety: avoids the nozzle becoming completely blocked

OSHA 1910.242 (b)/ OSHA 1910.95 (b)
2003/10/EC directive:
Requirement to use ear protection
if exposure > 8 hours

0690 06 01 Angle Nozzle (Short)

Nickel-plated brass, NBR

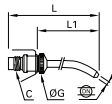

DN	C		G	L	L1	Kg
2.5	M12x1.25	0690 06 01	15	94	70	0.035



- Difficult access
- Progressive and powerful air jet, 360° rotation

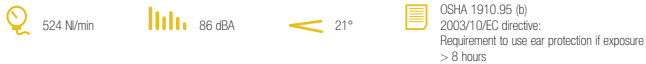

0690 08 COANDA Nozzle

Nickel-plated brass

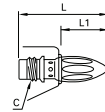

C			L	L1	Kg
M12x1.25	0690 08 00		47.5	26	0.033

Nozzle not compatible with Rectus blowguns



- Directional air jet
- Very quiet, energy-saving
- Safety: avoids the nozzle becoming completely blocked



0690 07 Nozzle with LF 3000® Push-In Connection

Nickel-plated brass, NBR

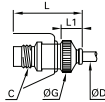

ØD	C		G	L	L1	Kg
4	M12x1.25	0690 07 00	15	35	13	0.024



- Restricted access
- Progressive air jet



0690 10 Safety Booster Nozzle

Nickel-plated brass

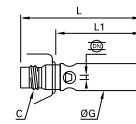

DN	C		G	L	L1	Kg
2.5	M12x1.25	0690 10 00	15	64	42	0.038



- High flow for blowing large surfaces
- Air screen effect
- Safety: avoids the nozzle becoming completely blocked



0690 09 Air Screen Safety Nozzle

Nickel-plated brass

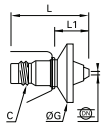

DN	C		G	L	L1	Kg
2	M12x1.25	0690 09 00	30	40.5	18.5	0.021

Deflector: technical polymer



- High flow for blowing large surfaces
- Air screen and deflector to avoid particles being blown back
- Safety: avoids the nozzle becoming completely blocked



0690 11 Safety Booster Nozzle with Air Screen

Nickel-plated brass

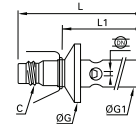

DN	C		G	G1	L	L1	Kg
2.5	M12x1.25	0690 11 00	30	15	76	54	0.045

Deflector: technical polymer



- Same advantage as the Booster nozzle
- Safety: avoids the nozzle becoming completely blocked
- Air screen and deflector avoid particles being blown back



Metal Blowguns



This range of robust blowguns guarantees a longer service life under severe conditions (crushing, impact, shock and corrosion). It includes two versions for blowing and spraying in industrial applications.

Technical Characteristics

Model	Metal Blowgun	Water Pistol
Compatible Fluids	Compressed air, industrial fluids	Water, oil, industrial fluids
Working Pressure	0 to 10 bar	0 to 20 bar
Working Temperature	Air: -15°C to +50°C Dry air: -20°C to +80°C	-20°C to +100°C
Tubes	Tubes and hoses	Braided hose with Parker couplers

Regulations

- PED
- REACH
- RoHS

Component Materials

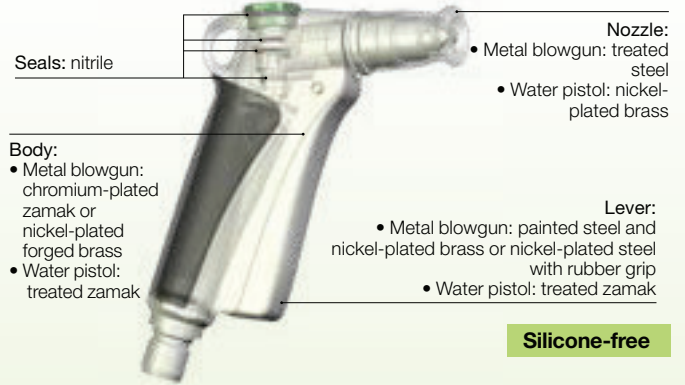

Advantages

Workshop blowgun

- Compact
- Nickel-plated forged brass for increased corrosion resistance

Water pistol

- The transmission of water and fluids
- Designed for precise flow control and optimisation of the power and shape of the jet
- Optimum use of industrial fluids

AA13S-01 Blowgun without nozzle, Female BSPB Thread but compatible with nozzles on previous page

Aluminium



C



G1/4 AA13S-01

AS13 Blowgun with safety nozzle, Female BSPB Thread

Aluminium



C



G1/4 AS13

AA13 Blowgun with standard nozzle, Female BSPB Thread

Aluminium



C



G1/4 AA13

AV13 Blowgun with extension tube, Female BSPB Thread

Aluminium



C



G1/4 AV13

0623 Lever-Operated Blowgun, Female BSPP Thread

Nickel-plated brass, zinc plated blister steel, NBR

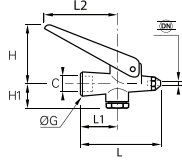

DN	C		G	H1	H max	H min	L	L1	L2	Kg
2	G1/4	0623 10 35	18	21	37	19	64	28	60	0.119

This blowgun has a hardened steel nozzle.

0622 Button-Operated Blowgun, Female BSPP Thread

Nickel-plated brass, zinc plated blister steel, NBR

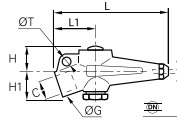

DN	C		G	H	H1	L	L1	T	Kg
2	G1/4	0622 26 73	18	17.5	20.5	82	29	7	0.199

This blowgun has a hardened steel nozzle.

2299 Water Pistol

Zamak, nickel-plated brass, NBR

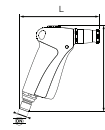

DN			H	L	Kg
12	2299 12 01		140	126	0.470

This pistol allows independent control of:
 - the flow rate (trigger) up to 1440 NI/min (air) and up to 16,2 NI/min (water)
 - type of jet (adjustable to a fine mist) by the adjustable nozzle

2299 Adjustable Nozzle

Nickel-plated brass, NBR

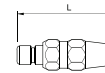

DN			L	Kg
12	2299 12 20		77.4	0.137

This nozzle allows adjustment of the spray.

Blowgun Kits



Ergonomic, the blowgun kit remains an essential item of equipment for blowing or spraying operation in industrial environment.

Technical Characteristics

- **Compatible Fluids:** Compressed air
Other fluids: contact us
- **Working Pressure:** 0 to 10 bar
- **Working Temperature:** Air: -15°C to +50°C
Dry air: -20°C to +80°C
- **Tubes:** Recoil tubing

Regulations

- **PED**
- **RoHS**
- **REACH**

Design protection:

All designs and models of Parker Legris blowguns have been registered with the following numbers:

- **13 224/13 225/13 226**
- **OSHA**
- **DI: 2003/10/CE**

Regulation relating to exposure to noise, particularly with regard to risks to hearing. The noise level must be less than 87 dBA

Component Materials

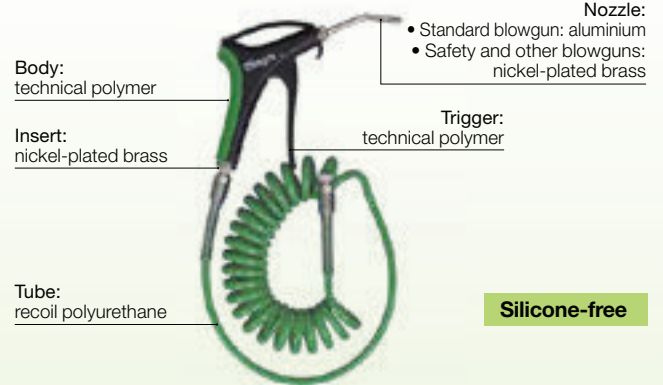

Silicone-free

Advantages

- **Kit contents:**
 - one blowgun
 - a 4 metre recoil tube
 - one R1/4 threaded fitting, external diameter 8 mm
- **Safety**
- **Optimisation of your energy consumption**
- **Minimum pressure drop**

0631..09 Blowgun Kit, Lower Connection, Male BSPT Thread

Technical polymer, Nickel-plated brass, treated aluminium, NBR

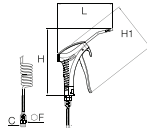

C	F	H	H1	L	Kg
R1/4 0631 00 09	16	192.5	139.5	152	0.441

Flow characteristics, noise level and norm compliance are identical to those of our blowguns (0659 00 13).

0631..23 Energy Saving Blowgun Kit with Angled Nozzle, Male BSPT Thread

Technical polymer, Nickel-plated brass, NBR

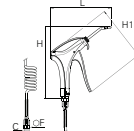

C	F	H	H1	L	Kg
R1/4 0631 00 23	16	195	148.5	163	0.456

Flow characteristics, noise level and norm compliance are identical to those of our blowguns (0653 66 13).
External diameter of tube 6 mm

0631..01 Safety Blowgun Kit, Lower Connection, Male BSPT Thread

Technical polymer, Nickel-plated brass, NBR

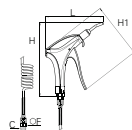

C	F	H	H1	L	Kg
R1/4 0631 00 01	16	198.5	148.5	154	0.575

Flow characteristics, noise level and norm compliance are identical to those of our blowguns (0654 00 13).

0631..05 Blowgun Kit Lower Connection with Short Angled Nozzle, Male BSPT Thread

Technical polymer, Nickel-plated brass, NBR

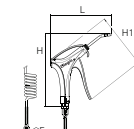

C	F	H	H1	L	Kg
R1/4 0631 00 05	16	195.5	148.5	163	0.536

Flow characteristics, noise level and norm compliance are identical to those of our blowguns (0656 66 13).

0631..07 Blowgun Kit, Lower Connection with Interchangeable Nozzle, Male BSPT Thread

Technical polymer, Nickel-plated brass, NBR

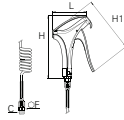

C		F	H	H1	L	Kg
R1/4	0631 00 07	16	163	148.5	91	0.617

Flow characteristics, noise level and norm compliance are identical to those of our blowguns (0656 66 13).
Delivered without nozzle.

#04

INDUSTRIAL VALVES

Ball Valves

LIQUIfit®

Needle and Butterfly Valves

Axial Valves



The Solution for Your Needs

How to choose your ball valves?

Which kind of valve do you need ?

• **Ball Valves**



• **Needle Valves**



• **Butterfly Valves**



Represents an interesting economical alternative compared with a ball valve

• **Axial Valves**



What are the conditions of use ?

- Pressure
- Temperature inside the system
- Sealing requirements
- Flow requirements
- 2 ways or 3 ways
- Normally closed / Normally open ?

What type of fluid is being conveyed ?

- Compatibility of materials with the fluid : body & seals

Which technology is required to connect your ball valves ?

- Compression
- Threaded
- Push-in connection

Have you considered the additional product requirements ?

- Compression fittings
- Tubing
- Solenoid valves

What is your application environment ?

- Internal or external environment
- Risk of shocks
- Air quality
- Regulations
- Corrosion risk
- Frequency of operation

What other functions are required ?

- Lockable
- Vented
- Frequency of operation
- Electric or pneumatic

Part Number Identification

0402 04 10

Valve type

0400
0401
0402
...













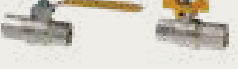

Length

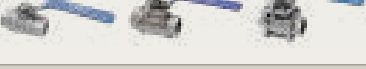
04 = 4 mm
05 = 5 mm
...
40 = 40 mm

Thread

10 = 1/8"
13 = 1/4"
...
48 = 2"

Product Specifications Overview

	Materials	Fluids	Maximum Pressure (bar)	Temperature		Page
				Min.	Max.	
Industrial Valves						
Universal and Customised Series Ball Valves 	Nickel-plated forged brass	Compressed air Other fluids (see compatibility chart at the end of this chapter)	40	-40°C	+80°C +100°C: please contact us	444
Universal Series, Vented 	Nickel-plated forged brass	Compressed air Other fluids (see compatibility chart at the end of this chapter)	40	-20°C	+80°C	447
Universal Series, Lockable 	Nickel-plated forged brass, galvanised steel and epoxy locking system	Compressed air Other fluids (see compatibility chart at the end of this chapter)	40	-40°C	+80°C	448
Universal Light Series 	Forged brass or nickel-plated forged brass	Compressed air Other fluids (see compatibility chart at the end of this chapter)	20	-20°C	+80°C	449
DVGW Series Ball Valves 	Nickel-plated brass	Compressed air Other fluids (see compatibility chart at the end of this chapter)	40	-40°C	+170°C	451
Standard Series Ball Valves 	Nickel or chromium plated brass	Compressed air Other fluids (see compatibility chart at the end of this chapter)	30	-20°C	+130°C	452
Stainless Steel Series Ball Valves 	Stainless steel 316L	All fluids	35	-20°C	+150°C	454
High Pressure Ball Valves 	Zinc-plated brass	Compressed air, lubricants, gases	300	-15°C	+80°C	456
Mini Series Ball Valves 	Technical polymer/ Nickel-plated brass	Compressed air	10	-20°C	+80°C	457
LIQUIfit® Ball Valves 	Polypropylène	Beverages, water, industrial water, CO ₂ , inert gases	10	-15°C	+100°C	459
Brass Needle Ball Valves 	Shot-blasted forged brass nickel-plated	Compressed air, water, industrial fluids Other fluids: please contact us	120	-20°C	+100°C	461
Stainless Steel Needle Valves 	Stainless steel 316L	All fluids	400	-20°C	+180°C	460
Butterfly Valves 	Shot-blasted forged brass nickel-plated	Compressed air, abrasive fluids	16	-20°C	+80°C	462
Axial Valves 	Nickel-plated brass	Compressed air, water, industrial fluids Other fluids: please contact us	10	-20°C	+135°C	463

Compatibility Table

The chart below shows the compatibility between valves and fluids along with their pressure and temperature characteristics.

Certain models have a maximum working pressure which differs from that given in this table. In this case, the pressure is shown in the heading for the model number in question.

N.B.: Above 32 mm or 1¼" diameters, divide the maximum pressure by 2.

If the fluid you are using is not shown in this chart, please contact us.

Chemical Description	Maximum Pressure (bar)	Temperature °C		Universal and Light Series	Standard Series	DVGW series
		Min.	Max.			
"Aromatic" hydrocarbons	20	-20	+60			
Acetone and other ketones	20	-20	+60			
Acetophenone	20	-20	+60			
Acetylene - Acetone	20	-20	+60			
Acetylene (gas)	20	-20	+60	●	●	●
Alcohol (100%)	20	-20	Boiling			
Aluminium (liquid suspension, thick)	40	-20	+90	●	●	●
Amyl alcohol	20	-20	Boiling			
Animal fats, greases	20	+5	+200		●	●
Antifreeze or glycol (diluted)	40	-20	+40	●	●	●
Argon (gas) Ar	20	-20	+60	●	●	●
Barium - Hydroxide	20	-20	+40			
Benzaldehyde	20	-20	+60			
Benzene	20	-20	+60			
Benzyl alcohol	20	-20	Boiling			
Borax (pastes or solutions)	20	-20	+60			
Brake fluids (automobile)	20	-20	+90			
Bromochlorotrifluorethane	20	-20	+60		●	●
Butadiene (hydrocarbon)	20	-20	+60			
Butane	20	-20	+60	●	●	●
Butanol	20	-20	Boiling			
Butyl alcohol	20	-20	Boiling			
Butylene (hydrocarbon)	20	-20	+60			
Carbon dioxide gas CO ₂	40	-20	+60	●	●	
Castor oil	40	-20	+90	●	●	
Compressed air	20	-25	+180	●	●	●
Creosotes	20	-20	+60			
Cresols	20	-20	+60			
Crude oil	20	-20	+40			
Cutting oil	40	-20	+90	●	●	
Decalin (hydrocarbon, solvent)	20	-20	+60			
Detergents (solutions)	20	-20	+100			
Diacetone alcohol	20	-20	Boiling			
Diesel oils	40	-20	+90	●	●	
Di-Esters	20	-20	+90			
Di-Isobutylene	20	-20	+60			
Di-Pentane	20	-20	+60			

The above recommendations are given in good faith. However, since each application is different, it is advisable to undertake tests in actual working conditions.

Compatibility Table

Chemical Description	Max. Pressure (bar)	Temperature °C		Universal and Light Series	Standard Series	DVGW Series
		Min.	Max.			
Di-Pentene (solvents, varnish)	20	-20	+60			
Di-Phenyl-Oxide (thin detergents)	20	-20	+60			
Distilled water	40		+90	●	●	●
Edible fats	20	+5	+200		●	
Edible oils	20	+5	+200		●	
Erytrene (see Butadiene)	20	-20	+60			
Ethane (gas) CH ₂ CH ₃	20	-20	+60	●	●	
Ethane (hydrocarbon gas)	20	-20	+60			
Ethyl alcohol	20	-20	+60			
Ethylene glycol (antifreeze) - see Glycols	20	-20	+120			
Fatty alcohols	20	-20	Boiling			
Fuel oils	40	-20	+40	●	●	●
Fuels-Diesels	40	-20	+40	●	●	
Gaseous oxygen (ambient air)	20	-20	+40			
Glycerine	20	-20	+40	●	●	
Glycol (for antifreeze, lubricants)	40	-20	+40	●	●	
Graphite in suspension in water, oils and greases	40	-20	+90	●	●	
Greases (from petroleum)	40	-20	+90	●	●	
Helium (gas)	20	-20	+60			
Heptanal	20	-20	+50	●	●	
Hexane (solvent)	20	-20	+60			
Hydraulic oils (petroleum-based)	40	-20	+90	●	●	
Hydrogen (gas)	20	-20	+60			
Inks	20	-20	+60			
Insecticides	20	0	+40	●	●	●
Iso-Butane (aliphatic hydrocarbon)	20	-20	+60			
Iso-Octane	20	-20	+60			
Isopropyl alcohol	20	-20	Boiling			
Krypton (gas) Kr	20	-20	+60	●	●	●
Light water	40		+80	●	●	●
Lighting gas	20	-20	+40			●
Methane (gas) CH ₄	20	-20	+60	●	●	●
Methanol	20	-20	Boiling			
Methyl alcohol	20	-20	Boiling			
Methylated spirit	40	-20	+40	●	●	●
Mineral oils	40	-20	+90	●	●	●
Natural gas	20	-20	+40			●
Natural waxes (vegetable, beeswax, carnauba, Chinese, lignite)	40	-20	+90			
Neatsfoot oil	40	-20	+90	●	●	●
Neon (Gas) Ne	20	-20	+60	●	●	●
Nitrogen (gas) N ²	40	-20	+90	●	●	●
Oil (petroleum-based) and water emulsions	40	-20	+90	●	●	●

The above recommendations are given in good faith. However, since each application is different, it is advisable to undertake tests in actual working conditions.

Compatibility Table

Chemical Description	Max. Pressure (bar)	Temperature °C		Universal and Light Series	Standard Series	DVGW Series
		Min.	Max.			
Oils "synthetic"	20	-20	+100			
Ordinary petrol	20	-20	+40	●	●	
Oxygenated water	40	-20	+30			
Paints and relevant solvents	20	-20	+60		●	●
Paraffin oil	40	-20	+90	●	●	●
Paraffins	20	-20	+60	●	●	●
Pentane (liquid hydrocarbon)	20	-20	+60	●	●	●
Pentanol 1 and 2	20	-20	Boiling			
Petrol "super"	20	-20	+40			
Petroleum mineral oils	20	-20	+160			
Phenol (aqueous or alcoholic)	20	-20	+60		●	●
Propane	20	-20	+60	●	●	●
Propanol 1 and 2	20	-20	Boiling			
Propanone 2	20	-20	+60			
Propene or Propylene	20	-20	+60			
Propyl alcohol	20	-20	Boiling			
Propylene or Propene	20	-20	+60			
Rapeseed oil	40	-20	+90	●	●	
Saponifying liquids	20	-20	+30	●	●	●
Seawater	40		+80	●	●	●
Seawater (high temperature)	20		+150			●
Soaps	20	-20	+100			
Soaps (liquid or paste)	40	-20	+40	●	●	●
Sodium carbonate (with water)	20	0	+40	●	●	●
Starch (gels or pastes)	40	+10	+40	●	●	●
Steam	20	-20	+150			
Toluene (terpenic hydrocarbon)	20	-20	+60		●	●
Trichlorethylene	20	-20	+65			
Turpentine	20	-20	+50	●	●	●
Varnish and paints	20	-20	+60		●	●
Vaseline	40	-20	+60	●	●	●
Vaseline oil	40	-20	+90	●	●	●
Water (carbonated)	40		+90	●	●	●
Water (high temperature)	20		+150			●
Xenon (gas) Xe	20	-20	+60	●	●	●
Xylene	20	-20	+60			

The above recommendations are given in good faith. However, since each application is different, it is advisable to undertake tests in actual working conditions.

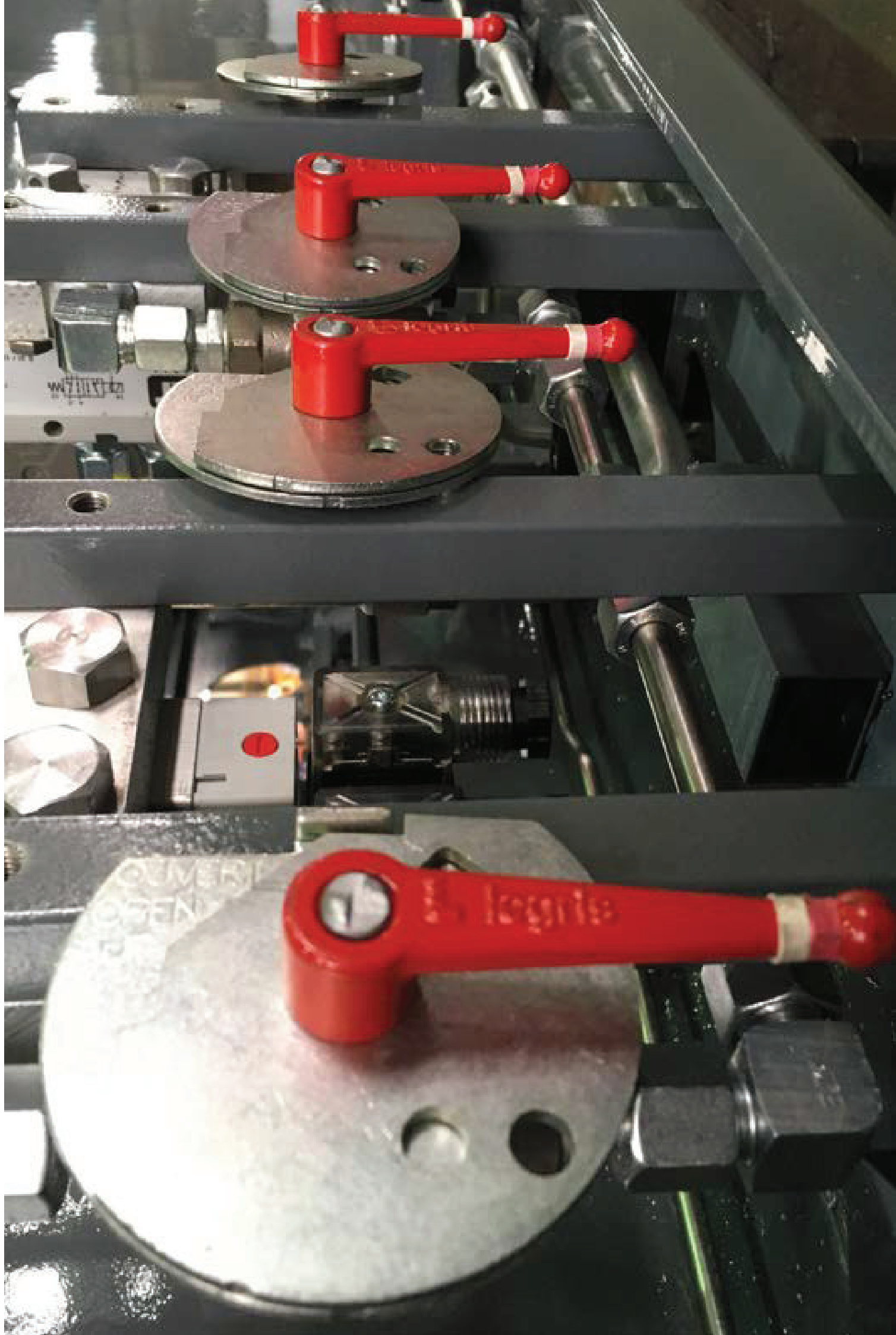

Universal Series



The seal wear compensating technology offers reliable and durable sealing, whether under pressure or vacuum.

Technical Characteristics

- **Compatible Fluids:** Compressed air
Other fluids: see compatibility chart at the end of this chapter
- **Working Pressure:** Vacuum up to 40 bar, depending on the model
- **Working Temperature:** -40°C to +80°C

Reliable performance is dependent upon the type of fluid conveyed, component materials and tubing being used.

Guaranteed for use with a vacuum of 755 mm Hg (99 % vacuum).

Advantages

- Automatic seal wear compensation
- Vacuum resistance
- Ease of operation
- Short, repositionable and exchangeable handles

Component Materials

Silicone-free

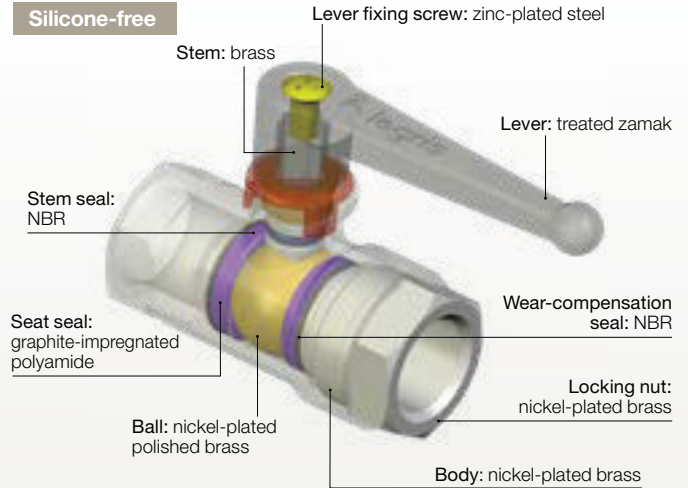

Regulations

- PED
- REACH
- RoHS

Installation Options

Lockable Valves

Our lockable ball valves have been developed in order to prevent potentially dangerous consequences caused by unintended operation. Lockable in different positions, this range meets international safety requirements, such as ISO 4414.

The valves are lockable:

- at one point: models 0432 and 0439
- at three points: models 0436, 0437 and 0438

Vented Valves

To stop fluid circulation and vent the circuit, 2 venting systems are provided:

- with threaded exhaust, to allow discharge of downstream media
- with pin-hole vent, for applications with no special discharge requirement

Fluid flow direction is indicated by an arrow on the valve body.

Mountable Valves

On steel plate:

- bulkhead fixing
- complete valve below bulkhead

On frame:

- assemble with bolts

On wooden panel:

- assemble with woodscrews

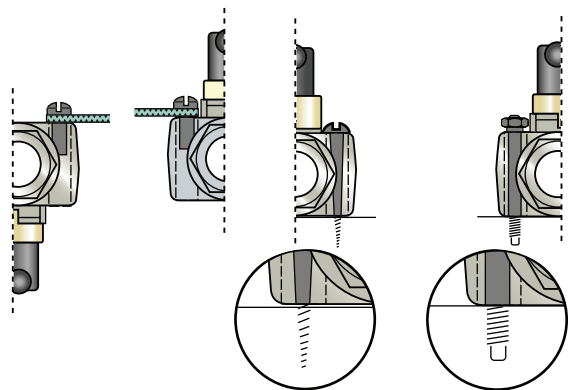

0400 2/2 In-Line Ball Valve, Male BSPP Thread

Nickel-plated brass, NBR

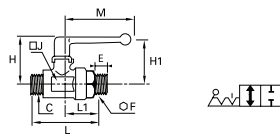

DN	C		E	F	H	H1	J	L	L1	M	Kg
4	G1/8	0400 04 10	7	14	35	29	14	45	25	48	0.094
7	G1/4	0400 07 13	9	19	38	31	19	60	36	48	0.166
10	G3/8	0400 10 17	11	24	45	43	24	70	43	69	0.252
13	G1/2	0400 13 21	12	27	47	44	27	78	45	69	0.324
18	G3/4	0400 18 27	12	38	63	54	39	90	50	108	0.714

Maximum working pressure: 40 bar

0411 2/2 In-Line Ball Valve with Connections for Use with Steel Tubing

Nickel-plated brass, NBR

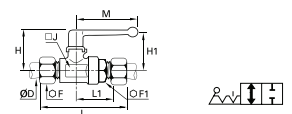

DN	ØD		F	F1	H	H1	J	L	L1	M	Kg
4	6	0411 04 06	14	19	38	31	19	76	30	48	0.173
6	8	0411 06 08	17	19	38	31	19	77	30	48	0.195
7	10	0411 07 10	19	19	38	31	19	78	31	48	0.210
10	12	0411 10 12	22	24	45	43	24	85	36	69	0.310

Maximum working pressure: 40 bar

0402 2/2 In-Line Ball Valve, Female BSPP Thread

Nickel-plated brass, NBR

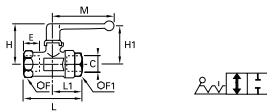

DN	C		E	F	F1	H	H1	L	L1	M	Kg
4	G1/8	0402 04 10	8	14	35	29	44	25	48	0.094	
7	G1/8	0402 07 10	8	19	19	38	31	51	27	48	0.165
	G1/4	0402 07 13	12	19	19	38	31	53	28	48	0.156
10	G3/8	0402 10 17	12	24	24	45	43	59	31	69	0.244
13	G1/2	0402 13 21	15	27	27	47	44	67	34	69	0.292
20	G3/4	0402 20 27	16.5	32	38	63	54	80	39	108	0.655
23	G1	0402 23 34	19	41	46	67	57	94	47	108	1.036
32	G1 1/4	0402 32 42*	21.5	55	60	97	115	112	59	180	2.467
	G1 1/2	0402 32 49*	22	55	60	97	115	120	62	180	2.340
40	G1 1/2	0402 40 49*	22	55	55	104		111	55	190	2.445
	G2	0402 40 48*	26	70	70	104		122	61	190	2.614

*Models with EC marking
Maximum working pressure: 40 bar

0401 2/2 In-Line Ball Valve, Male/Female BSPP Thread

Nickel-plated brass, NBR

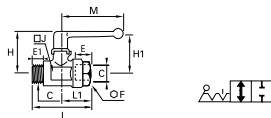

DN	C		E	E1	F	H	H1	J	L	L1	M	Kg
4	G1/8	0401 04 10	8	7	14	35	29	14	45	25	48	0.094
5	G1/8	0401 05 10	8	7	19	38	31	19	51	27	48	0.160
7	G1/4	0401 07 13	12	9	19	38	31	19	52	28	48	0.150
10	G3/8	0401 10 17	12	11	24	45	43	24	58	31	69	0.234
13	G1/2	0401 13 21	15	12	27	47	44	27	66	34	69	0.286
18	G3/4	0401 18 27	16.5	12	38	63	54	39	79	39	108	0.652
23	G1	0401 23 34	19	15	46	67	57	48	91	47	108	0.952
32	G1 1/4	0401 32 42*	21.5	18	60	97	115	55	113	59	108	2.385

*Models with EC marking
Maximum working pressure: 40 bar

0414 2/2 In-Line Ball Valve with Compression Connections

Nickel-plated brass, NBR

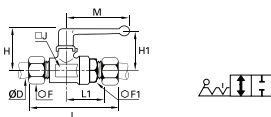

DN	ØD		F	F1	H	H1	J	L	L1	M	Kg
4	6	0414 04 06	13	19	38	31	19	72	31	48	0.177
6	8	0414 06 08	14	19	38	31	19	74	30	48	0.180
7	10	0414 07 10	19	19	38	31	19	78	31	48	0.210
10	12	0414 10 12	22	24	45	43	24	86	36	69	0.308

Maximum working pressure: 40 bar

0446 2/2 In-Line Panel-Mountable Ball Valve, Female BSPP Thread

Nickel-plated brass, NBR

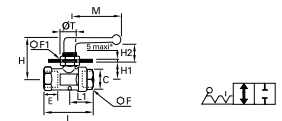

DN	C		E	F	F1	H	H1	H2	L	L1	M	T	Kg
4	G1/8	0446 04 10*	8	14	22	37	14	12	44	25	48	16.5	0.112
7	G1/4	0446 07 13	12	19	24	45	19	14	53	28	48	20.5	0.188
10	G3/8	0446 10 17	12	24	27	50	21	21	59	31	69	20.5	0.294
13	G1/2	0446 13 21	15	27	27	51	23	21	67	34	69	20.5	0.338

Maximum working pressure: 20 bar
*For G1/8 version, maximum panel thickness = 3 mm

6402 2/2 In-Line Ball Valve for Screw Fixing, Female BSPP Thread

Nickel-plated brass, NBR

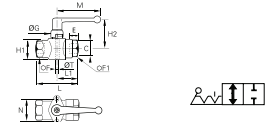

DN	C		E	F	F1	G	H1	H2	L	L1	M	N	T	Kg
4	G1/8	6402 04 10	8	14	14	18	18	30	44	25	48	25	470	0.132
7	G1/4	6402 07 13	12	19	19	19	24	31	53	28	48	31	580	0.216
10	G3/8	6402 10 17	12	24	24	20	30	45	59	31	69	31	580	0.324
13	G1/2	6402 13 21	15	27	27	20	34	47	67	34	69	34	6100	0.404
20	G3/4	6402 20 27	16.5	32	38	27	44	52	80	39	108	43	8125	0.830
23	G1	6402 23 34	19	41	46	27	53	56	94	47	108	51	8125	1.290

Maximum working pressure: 40 bar

6401 2/2 In-Line Ball Valve for Screw Fixing, Male/Female BSPP Thread

Nickel-plated brass, NBR

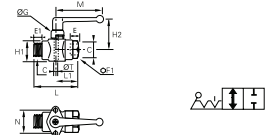

DN	C		E	E1	F	G	H1	H2	L	L1	M	N	T	Kg
4	G1/8	6401 04 10	8	7	14	18	18	30	45	25	48	25	470	0.127
7	G1/4	6401 07 13	12	9	19	19	24	31	52	28	48	31	580	0.212
10	G3/8	6401 10 17	12	11	24	20	30	45	58	31	69	31	580	0.306
13	G1/2	6401 13 21	15	12	27	20	34	47	67	34	69	34	6100	0.394

Maximum working pressure: 40 bar

0472 2/2 Right-Angled Ball Valve, Female BSPP Thread

Nickel-plated brass, NBR

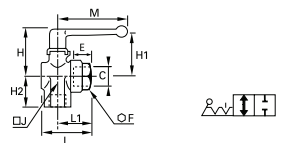

DN	C		E	F	H	H1	H2	J	L	L1	M	Kg
4	G1/8	0472 04 10	8	14	35	29	18	14	34	25	48	0.096
6	G1/4	0472 06 13	12	19	38	31	24	22	38	28	48	0.191
9	G3/8	0472 09 17	12	24	45	43	27	25	46	31	69	0.260
12	G1/2	0472 12 21	15	27	47	44	33	29	49	34	69	0.312
18	G3/4	0472 18 27	16.5	38	59	51	40	39	60	39	108	0.704
23	G1	0472 23 34	19	46	63	55	47	48	72	47	108	1.062

Maximum working pressure: 20 bar

0471 2/2 Right-Angled Ball Valve, Male/Female BSPP Thread

Nickel-plated brass, NBR

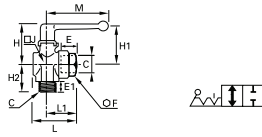

DN	C		E	E1	F	H	H1	H2	J	L	L1	M	Kg
4	G1/8	0471 04 10	8	7	14	35	29	19	14	34	25	48	0.096
6	G1/8	0471 06 10	8	7	19	38	31	22	22	37	27	48	0.182
	G1/4	0471 06 13	12	9	19	38	31	25	22	38	28	48	0.187
9	G3/8	0471 09 17	12	11	24	45	43	28	25	46	31	69	0.256
12	G1/2	0471 12 21	15	12	27	47	44	32	29	49	34	69	0.303
18	G3/4	0471 18 27	16.5	12	38	59	51	37	39	60	39	108	0.682
23	G1	0471 23 34	19	15	46	63	55	44	48	72	47	108	1.020

Maximum working pressure: 20 bar

0482 3/3 Right-Angle Ported Ball Valve, Female BSPP Thread

Nickel-plated brass, NBR

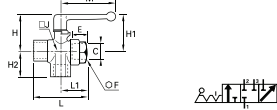

DN	C		E	F	H	H1	H2	J	L	L1	M	Kg
4	G1/8	0482 04 10	8	14	35	29	18	14	44	25	48	0.102
6	G1/4	0482 06 13	12	19	38	31	24	22	53	28	48	0.200
9	G3/8	0482 09 17	12	24	45	43	27	25	59	31	69	0.284
12	G1/2	0482 12 21	15	27	47	44	33	29	67	34	69	0.346
18	G3/4	0482 18 27	16.5	38	59	51	40	39	80	39	108	0.742
23	G1	0482 23 34	19	46	63	55	47	48	94	47	108	1.160

Maximum working pressure: 20 bar

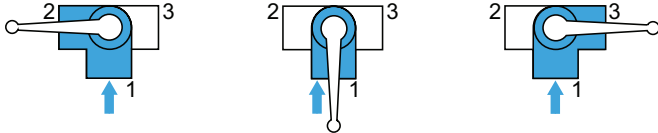

0483 3/3 Right-Angle Ported Ball Valve Without Closed Position, Female BSPP Thread

Nickel-plated brass, NBR

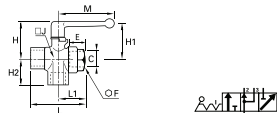

DN	C		E	F	H	H1	H2	J	L	L1	M	Kg
4	G1/8	0483 04 10	8	14	35	29	18	14	44	25	48	0.102
6	G1/4	0483 06 13	12	19	38	31	24	22	53	28	48	0.196
9	G3/8	0483 09 17	12	24	45	43	27	25	59	31	69	0.278
12	G1/2	0483 12 21	15	27	47	44	33	29	67	34	69	0.340
18	G3/4	0483 18 27	16.5	38	59	51	40	39	80	39	108	0.716
23	G1	0483 23 34	19	46	63	55	47	48	94	47	108	1.066

Maximum working pressure: 20 bar

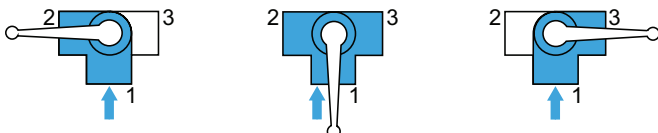

0448 3/3 Panel-Mountable Right-Angled Ball Valve, Female BSPP Thread

Nickel-plated brass, NBR

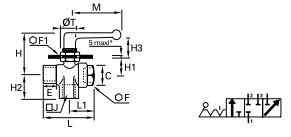

DN	C		E	F	F1	H	H1	H2	H3	J	L	L1	M	T	Kg
4	G1/8	0448 04 10*	8	14	22	37	14	18	12	14	44	25	48	16.5	0.126
6	G1/4	0448 06 13	12	19	24	45	19	24	14	22	53	28	48	20.5	0.230
9	G3/8	0448 09 17	12	24	27	50	21	27	21	25	59	31	69	20.5	0.328
12	G1/2	0448 12 21	15	27	27	51	23	33	21	29	67	34	69	20.5	0.392

Maximum working pressure: 20 bar

*For G1/8 version: maximum panel thickness = 3 mm

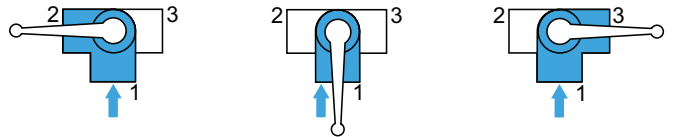

0452 3/2 Panel-Mountable Equal Plane Ball Valve, Female BSPP Thread

Nickel-plated brass, NBR

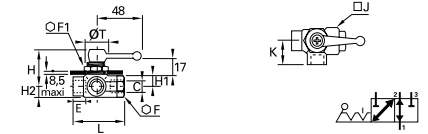

DN	C		E	F	F1	H	H1	H2	J	K	L	T	Kg
4	G1/8	0452 04 10	8	14	22	39	10	8	16	18	25	19	0.130
6	G1/4	0452 06 13	12	19	24	40	11	11	23	24	28	20	0.206

Maximum working pressure: 20 bar

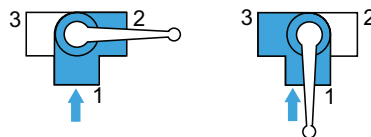

0489 3/2 In-Line Threaded Exhaust Port Ball Valve, Female BSPP and Metric Thread

Nickel-plated brass, NBR

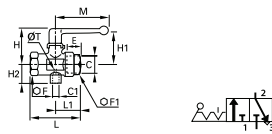

DN	C1	C	E	F	F1	H	H1	H2	L	L1	M	T	Kg	
7	M5x0.8	G1/4	0489 07 13	12	24	24	46	43	17	59	31	69	2	0.270
10	M5x0.8	G3/8	0489 10 17	12	24	24	46	43	17	59	31	69	2	0.243
13	G1/8	G1/2	0489 13 21	15	27	27	47	44	24	67	34	69	2	0.310
18	G1/4	G3/4	0489 18 27	16.5	32	38	63	54	33	80	39	108	2.5	0.670
23	G1/4	G1	0489 23 34	19	41	46	67	57	37	94	47	108	3	1.050

Maximum working pressure: 40 bar

0462 3/2 Right-Angled Ball Valve with Vent, Female BSPP Thread

Nickel-plated brass, NBR

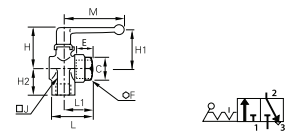

DN	C	E	F	H	H1	H2	J	L	L1	M	Kg	
6	G1/8	0462 06 10	8	19	38	31	20	22	37	27	48	0.192
	G1/4	0462 06 13	12	19	38	31	24	22	38	28	48	0.185
9	G3/8	0462 09 17	12	24	45	43	27	25	46	31	69	0.261
12	G1/2	0462 12 21	15	27	47	44	33	29	49	34	69	0.311
18	G3/4	0462 18 27	16.5	38	59	51	40	39	60	39	108	0.698
23	G1	0462 23 34	19	46	63	55	47	48	72	47	108	1.066

Maximum working pressure: 20 bar

0449 3/2 Panel-Mountable In-Line Threaded Exhaust Port Ball Valve, Female BSPP and Metric Thread

Nickel-plated brass, NBR

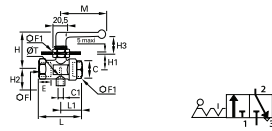

DN	C1	C	E	F	F1	H	H1	H2	H3	L	L1	M	T	Kg	
7	M5x0.8	G1/4	0449 07 13	12	24	27	50	20	17	21	59	31	69	2.5	0.313
10	M5x0.8	G3/8	0449 10 17	12	24	27	50	20	17	21	59	31	69	2.5	0.291
13	G1/8	G1/2	0449 13 21	15	27	27	52	23	24	21	67	34	69	4	0.352

Maximum working pressure: 20 bar

0461 3/2 Right-Angled Ball Valve with Vent, Male/Female BSPP Thread

Nickel-plated brass, NBR

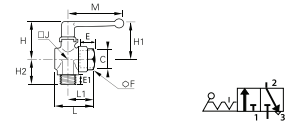

DN	C	E	E1	F	H	H1	H2	J	L	L1	M	Kg	
6	G1/8	0461 06 10	8	7	19	38	31	20	22	37	27	48	0.182
	G1/4	0461 06 13	12	9	19	38	31	24	22	38	28	48	0.186
9	G3/8	0461 09 17	12	11	24	45	43	27	25	46	31	69	0.257
12	G1/2	0461 12 21	15	12	27	47	44	33	29	49	34	69	0.304
18	G3/4	0461 18 27	16.5	12	38	59	51	40	39	60	39	108	0.648

Maximum working pressure: 20 bar

0469 3/2 In-Line Vented Ball Valve, Female BSPP Thread

Nickel-plated brass, NBR

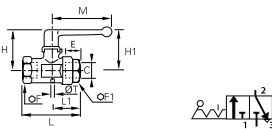

DN	C	E	F	F1	H	H1	L	L1	M	T	Kg	
4	G1/8	0469 04 10	8	14	14	35	29	44	25	48	1.5	0.092
7	G1/4	0469 07 13	12	24	24	46	43	59	31	70	2	0.268
10	G3/8	0469 10 17	12	24	24	46	43	59	31	70	2	0.246
13	G1/2	0469 13 21	15	27	27	47	44	67	34	70	2	0.294
18	G3/4	0469 18 27	16.5	32	38	63	54	80	39	108	2.5	0.668
23	G1	0469 23 34	19	41	46	67	57	94	47	108	3	1.026

Maximum working pressure: 40 bar

Operation of Vented Ball Valves

With vent connected to a tube = collection of purged media

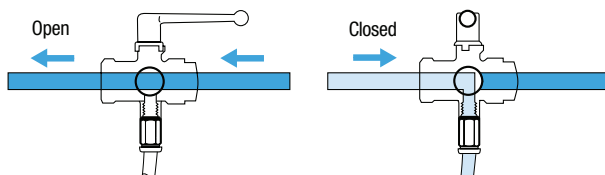

With vent connected to a silencer = noiseless discharge to atmosphere

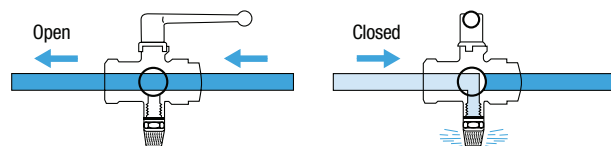

Universal Series, Lockable

0432 2/2 In-Line Lockable Ball Valve, Female BSPP Thread

Nickel-plated brass, NBR

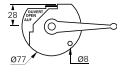
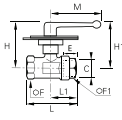

DN	C		E	F	F1	H	H1	L	L1	M	Kg
4	G1/8	0432 04 10	8	19	19	59	54	51	27	69	0.415
7	G1/4	0432 07 13	12	19	19	59	54	59	28	69	0.396
10	G3/8	0432 10 17	12	24	24	60	55	59	31	69	0.460
13	G1/2	0432 13 21	15	27	27	62	57	67	34	69	0.510
20	G3/4	0432 20 27	16.5	32	38	66	56	80	39	108	0.800
23	G1	0432 23 34	19	41	46	70	59	94	47	108	1.186

Maximum working pressure: 40 bar
Handle is not removable.
Fixed and mobile plates: zinc-plated steel.

0437 3/2 In-line Vented 3-Point Lockable Ball Valve, Female BSPP Thread

Nickel-plated brass, NBR

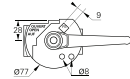
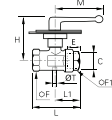

DN	C		E	F	F1	H	L	L1	M	T	Kg
7	G1/4	0437 07 13	12	24	24	60	59	32	69.5	2	0.476
10	G3/8	0437 10 17	12	24	24	60	60	32	69.5	2	0.447
13	G1/2	0437 13 21	15	27	27	60	67.5	34.5	69.5	2	0.510
18	G3/4	0437 18 27	16.5	32	38	69.5	80	39.5	108.5	2.5	0.820
23	G1	0437 23 34	19	41	46	73	94.5	47.5	108.5	3	1.192

Maximum working pressure: 40 bar
Handle is not removable
Locking plates are zinc-plated steel

0439 3/2 In-line Vented Lockable Ball Valve, Female BSPP Thread

Nickel-plated brass, NBR

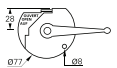
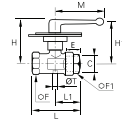

DN	C		E	F	F1	H	H1	L	L1	M	T	Kg
4	G1/8	0439 04 10	8	19	19	59	54	51	27	69	2	0.410
7	G1/4	0439 07 13	12	24	24	60	55	59	31	69	2	0.480
10	G3/8	0439 10 17	12	24	24	60	55	59	31	69	2	0.460
13	G1/2	0439 13 21	15	27	27	62	57	67	34	69	2	0.514
18	G3/4	0439 18 27	16.5	32	38	66	56	80	39	108	2.5	0.810
23	G1	0439 23 34	19	41	46	70	59	94	47	108	3	1.185

Maximum working pressure: 40 bar
Handle is not removable, locking plates are zinc-plated steel.

0438 3/2 Right-Angled 3-Point Lockable Ball Valve, Female BSPP Thread

Nickel-plated brass, NBR

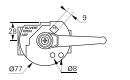
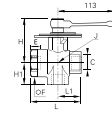

DN	C		E	F	H	H1	J	L	L1	Kg
9	G3/8	0438 09 17	12	38	76	34	39	73	35	0.970
12	G1/2	0438 12 21	15	38	76	37	39	78	38	0.947
18	G3/4	0438 18 27	16.5	38	76	40	39	80	40	0.905
23	G1	0438 23 34	19	46	80	47	48	94	47	1.295

Maximum working pressure: 20 bar
Fixed plate: zinc-plated steel, mobile plate: zinc-plated steel
Removable handle: where the handle is obstructed in its movement, it can be refitted opposite the original position.

0436 3/2 In-Line 3-Point Lockable Ball Valve with Threaded Exhaust Port, Female BSPP and Metric Thread

Nickel-plated brass, NBR

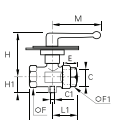

DN	C1	C		E	F	F1	H	H1	L	L1	M	Kg
10	M5x0.8	G3/8	0436 10 17	12	24	24	60	17	60	32	69	0.475
13	G1/8	G1/2	0436 13 21	15	27	27	60	24.5	67.5	34.5	69	0.500
18	G1/4	G3/4	0436 18 27	16.5	32	38	69.5	33	80	39.5	108	0.850
23	G1/4	G1	0436 23 34	19	41	46	73.5	47.5	94.5	47.5	108.5	1.215

Maximum working pressure: 40 bar
Handle is not removable.
Fixed and mobile plates: zinc-plated steel

Universal Light Series



Suitable for small, compact and resistant spaces, these ball valves are easy to operate.

Technical Characteristics

- **Compatible Fluids:** Industrial fluids
- **Working Pressure:** Vacuum to 12 bar
- **Working Temperature:** -20°C to +80°C

Reliable performance is dependent upon the type of fluid conveyed, component materials and tubing being used.

Guaranteed for use with a vacuum of 755 mm Hg (99% vacuum).

Advantages

- Compactness
- Corrosion resistance due to chemical nickel plating
- Automatic compensation of seal wear
- Repositionable and exchangeable handles

Regulations

- PED
- REACH
- RoHS

Component Materials

Silicone-free

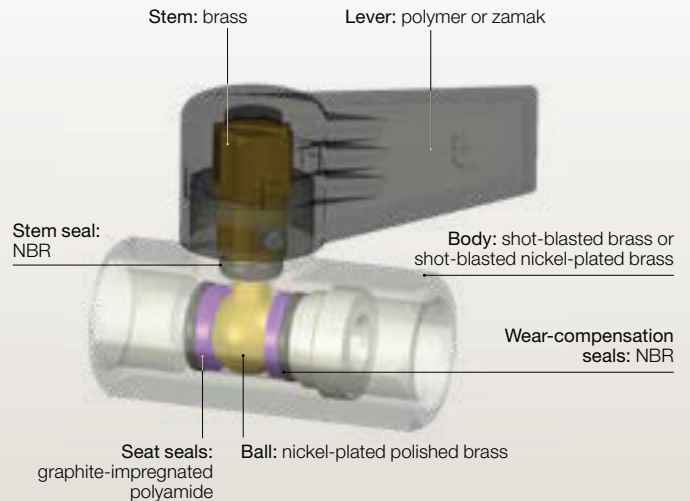

0492 2/2 In-Line Ball Valve, Female BSPP Thread

Nickel-plated brass, NBR



DN	C		E	F	H	L	L1	M	Kg
4	G1/4	0492 04 13	9	17	34	39.5	17	35	0.073
7	G3/8	0492 07 17	11	22	38	45	20	43	0.128
10	G1/2	0492 10 21	12	24	44	54	25	50	0.150
13	G3/4	0492 13 27	14	30	46	62	28	50	0.240

Technical polymer handle

0491 2/2 In-Line Ball Valve, Male/Female BSPP Thread

Nickel-plated brass, NBR



DN	C		E	E1	F	H	L	L1	M	Kg
4	G1/4	0491 04 13	9	7	17	34	39.5	17	35	0.070
7	G3/8	0491 07 17	11	8	22	38	45	20	43	0.124
10	G1/2	0491 10 21	12	10	24	44	53	24	50	0.160
13	G3/4	0491 13 27	14	12	30	46	59	25	50	0.238

Technical polymer handle

0492..64 2/2 In-Line Ball Valve, Short Handle, Female BSPP Thread

Nickel-plated brass, NBR

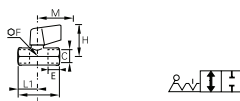

DN	C		E	F	H	L	L1	M	Kg
4	G1/4	0492 04 13 64	9	17	36	39.5	17	25	0.090

Short handle in zamak

0491..64 2/2 In-Line Ball Valve, Short Handle, Male/Female BSPP Thread

Nickel-plated brass, NBR

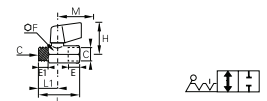

DN	C		E	E1	F	H	L	L1	M	Kg
4	G1/4	0491 04 13 64	9	7	17	36	39.5	17	25	0.092

Short handle in zamak

0490 2/2 In-Line Ball Valve, Male BSPP Thread

Nickel-plated brass, NBR

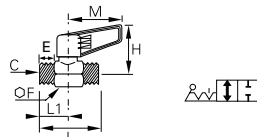

DN	C		E	F	H	L	L1	M	Kg
4	G1/4	0490 04 13	7	17	34	39	17	35	0.070
7	G3/8	0490 07 17	8	22	38	44	20	43	0.109
10	G1/2	0490 10 21	10	24	44	53	24	50	0.160
13	G3/4	0490 13 27	12	30	46	59	25	50	0.233

Technical polymer handle

0497 2/2 Ball Valve, Square Stem, Female BSPP Thread

Brass, NBR

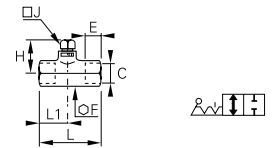

DN	C		E	F	H	J	L	L1	Kg
4	G1/4	0497 04 13	9	17	25	7	39	17	0.063
7	G3/8	0497 07 17	11	22	26	7	45	20	0.122
10	G1/2	0497 10 21	12	24	29	10	54	25	0.141
13	G3/4	0497 13 27	14	30	30	10	62	28	0.230

0494 2/2 In-Line Ball Valve, 2 Vent Plugs, Female BSPP Thread

Nickel-plated brass, NBR

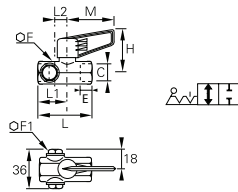

DN	C		E	F	F1	H	L	L1	L2	M	Kg
7	G3/8	0494 07 17	11	22	16	38	60	20	15	43	0.178

Technical polymer handle

0496 2/2 Ball Valve, Square Stem, Male/Female BSPP Thread

Brass, NBR

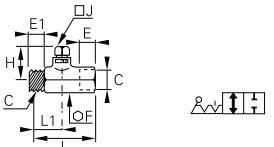

DN	C		E	E1	F	H	J	L	L1	Kg
4	G1/4	0496 04 13	7	9	17	25	7	39	17	0.065
7	G3/8	0496 07 17	8	11	22	26	7	45	20	0.118
10	G1/2	0496 10 21	10	12	24	29	10	53	24	0.150
13	G3/4	0496 13 27	12	14	30	30	10	59	28	0.222



Compliant with DVGW certification, standardized threads, these valves ensure the transport of gas and water.

Technical Characteristics

- **Compatible Fluids:** Compressed air, water, gas
- **Working Pressure:** 1/4" to 2": 0 to 40 bar
- **Working Temperature:** -50°C to +170°C

Reliable performance is dependent upon the type of fluid conveyed.

Products have been tested at -50°C in static sealing and after 5 operations for a leak rate < 0,05Nl/h.

Advantages

- Stem prevented from being ejected in the event of overpressure
- Two stem seal to prevent leakage
- Corrosion resistance, increased chemical compatibility thanks to chemical nickel plating
- Can be operated at very low temperatures: -50°C

Component Materials

Silicone-free

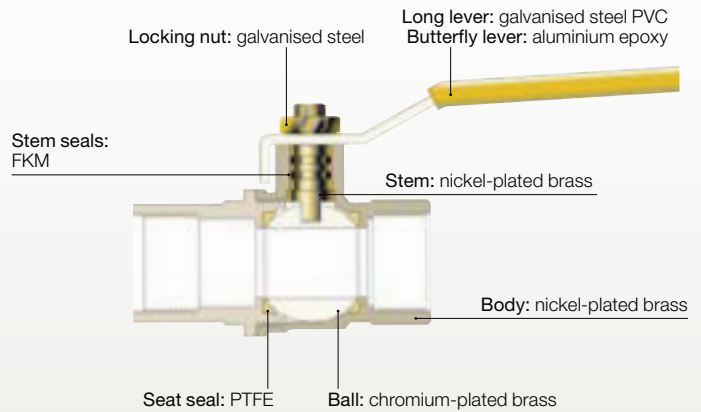

Working Pressure and Temperature

Pressure - Temperature

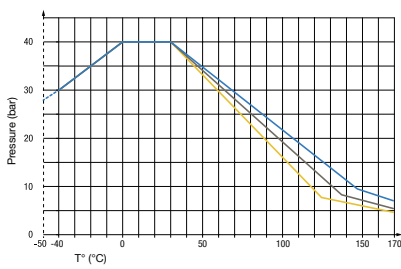

Pressure Drop

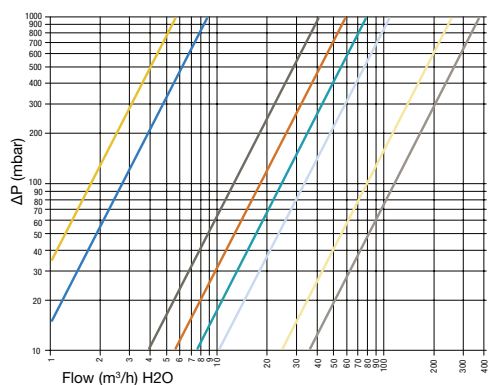

Regulations

Industrial
 DI: 97/23/EC
 (PED B+D module EC 1115)

Water
 DVGW: W 570-1
 DIN EN 13228
 BGA KTW
 DVGW: W270

Gas
 DIN EN 33

BVG4-L 2/2 In-Line Ball Valve, Female BSPP Thread

Nickel-plated brass

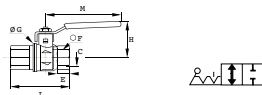

DN	C		E	F	G	H	L	M	Kg
8	G1/4	BVG4-1/4L	12	20	25	38	50	82	0.150
10	G3/8	BVG4-3/8L	12	20	25	38	60	82	0.161
15	G1/2	BVG4-1/2L	15.5	25	32.5	43	75	100	0.256
20	G3/4	BVG4-3/4L	17	32	39	50	80	120	0.397
25	G1	BVG4-1L	21	41	47.5	54	90	120	0.641
32	G1 1/4	BVG4-1.1/4L	23	50	59	73	110	158	0.980
40	G1 1/2	BVG4-1.1/2L	23	55	71.5	79	120	158	1.205
50	G2	BVG4-2L	26.5	70	86	86	140	158	1.960

BVGT4-L 2/2 In-Line Ball Valve, Female BSPP Thread, Butterfly Handle

Nickel-plated brass

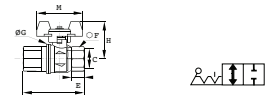

DN	C		E	F	G	H	L	M	Kg
8	G1/4	BVGT4-1/4L	12	20	25	39	50	50	0.137
10	G3/8	BVGT4-3/8L	12	20	25	39	60	50	0.129
15	G1/2	BVGT4-1/2L	15.5	25	32.5	43	75	50	0.231
20	G3/4	BVGT4-3/4L	17	32	39	47	80	60	0.348
25	G1	BVGT4-1L	21	41	47.5	51	90	60	0.546

Compact lever

Standard Series



For common industrial applications, these ball valves are equipped with fluoropolymer seals and a lockable system.

Technical Characteristics

Model	Standard and Lockable Series	Compact Series
Compatible Fluids	Compressed air Other fluids : see compatibility chart at the end of this chapter	
Working Pressure	0 to 40 bar up to 2" 0 to 30 bars over 2" excepted BVG4P-LOCK: 0 to 14 bar	0 to 30 bar
Working Temperature	-20°C to +170°C Excepted BVG4P-LOCK: -10°C to +100°C	-10°C to +90°C

Reliable performance is dependent upon the type of fluid conveyed.

Advantages

- Long or butterfly handle
- Full fluid flow
- A lockable version for safety in use
- Corrosion resistance thanks to chemical nickel plating

Component Materials

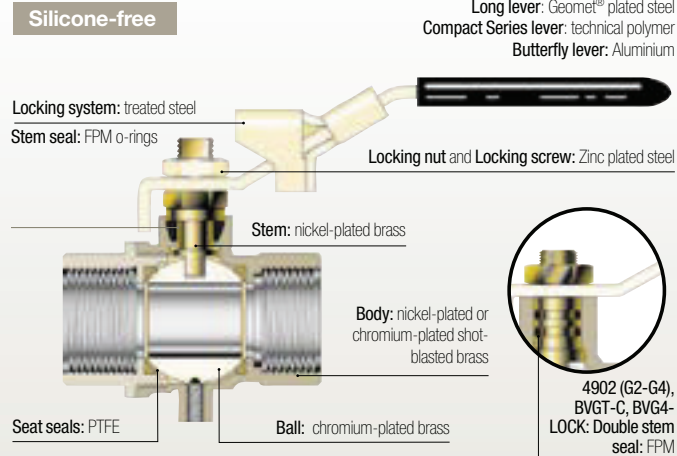

Regulations

- Industrial:
- PED
 - REACH
 - RoHS

4902 2/2 Standard In-Line Ball Valve, Female BSPP Thread

Nickel-plated brass, PTFE

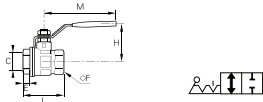

DN	C	Icon	E	F	H	L	M	PN	Kg	
8	G1/4		4902 10 13	9	20	38	39	82	40	0.131
10	G3/8		4902 10 17	9	20	38	39	82	40	0.117
15	G1/2		4902 15 21	11	25	43	50	100	40	0.204
20	G3/4		4902 20 27	12	31	50	54	120	40	0.329
25	G1		4902 25 34	14	38	54	67	120	40	0.468
32	G1 1/4		4902 32 42*	15	48	73	77	158	30	0.770
40	G1 1/2		4902 40 49*	17	54	79	90	158	30	1.040
50	G2		4902 50 48*	19	66	86	106	158	30	1.760
65	G2 1/2		4902 65 47*	22	85	132	136	255	30	4.500
80	G3		4902 80 46*	25	99	140	157	255	30	5.840
100	G4		4902 01 45*	29	125	154	191	255	30	9.040

*Models with EC marking
Model from 2 1/2": double stem seal in FPM
Working temperature: -20°C to +170°C

4991 2/2 Standard Compact In-Line Ball Valve, Male/Female BSPP Thread

Chromium brass, PTFE

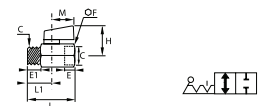

DN	C	Icon	E	E1	F	H	L	L1	M	Kg	
6	G1/8		4991 00 10	10	10	21	30	41.5	10	24	0.089
8	G1/4		4991 00 13	11	11	21	30	41.5	11	24	0.082
	G3/8		4991 00 17	11	11	21	30	41.5	10.5	24	0.087
10	G1/2		4991 00 21	13	13	25	32	49	12.5	24	0.134

4992 2/2 Standard Compact In-Line Ball Valve, Female BSPP Thread

Chromium brass, PTFE

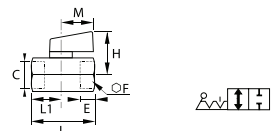

DN	C	Icon	E	F	H	L	L1	M	Kg	
6	G1/8		4992 00 10	10	21	30	41.5	10	24	0.111
8	G1/4		4992 00 13	11	21	30	41.5	11	24	0.100
	G3/8		4992 00 17	11	21	30	41.5	10.5	24	0.094
10	G1/2		4992 00 21	13	25	32	49	12.5	24	0.142

BVGT4-C 2/2 Standard In-Line Ball Valve, Female BSPP Thread, Butterfly Handle

Nickel-plated brass

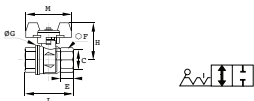

DN	C		E	F	G	H	L	M	Kg
8	G1/4	BVGT4-1/4C	9	20	25	40	39	50	0.130
10	G3/8	BVGT4-3/8C	9	20	25	40	39	50	0.120
15	G1/2	BVGT4-1/2C	11	25	32.5	44	50	50	0.180
20	G3/4	BVGT4-3/4C	12	31	39	49	54	50	0.265
25	G1	BVGT4-1C	14	38	47.5	53	67	50	0.390

Compact lever Double stem seal in FPM
Working temperature: -40°C to +170°C

BVG4-LOCK 2/2 In-Line Lockable Ball Valve, Female BSPP Thread

Nickel-plated brass

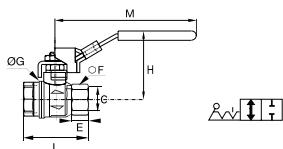

DN	C		E	F	H	L	M	Kg
8	G1/4	BVG4-1/4LOCK	9	20	46	39	96	0.150
10	G3/8	BVG4-3/8LOCK	9	20	46	39	96	0.150
15	G1/2	BVG4-1/2LOCK	11	25	51	50	96	0.255
19	G3/4	BVG4-3/4LOCK	12	31	59	54	117	0.390
25	G1	BVG4-1LOCK	14	38	63	67	117	0.590

BVG4P-LOCK 3/2 In-Line Lockable Vented Ball Valve, Female BSPP Thread

Nickel-plated brass

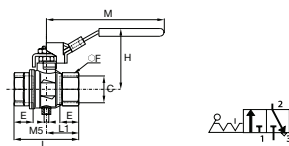

DN	C		E	F	H	L	L1	M	Kg
8	G1/4	BVG4P-1/4LOCK	12	20	47.5	45	22.5	96	0.155
10	G3/8	BVG4P-3/8LOCK	12	20	47.5	45	22.5	96	0.172
15	G1/2	BVG4P-1/2LOCK	15.5	25	52	59	29.5	96	0.239
20	G3/4	BVG4P-3/4LOCK	17	31	59.5	64	32	117	0.371
25	G1	BVG4P-1LOCK	21	40	63.5	81	40.5	117	0.581

Stainless Steel Series



For severe food or industrial process applications, a series with a 316L stainless steel body that withstands aggressive environments, as well as high pressures and temperatures.

Technical Characteristics

Compatible Fluids	Types 4810, 4812 and 4832	Type 0465	
	All fluids	All fluids	
	Working Pressure	0 to 65 bar	Vacuum to 20 bar
	Working Temperature	-20°C to +150°C	-20°C to +120°C

Reliable performance is dependent upon the type of fluid conveyed, component materials and tubing being used.

Guaranteed for use with a vacuum of 755 mm Hg (99% vacuum).

Advantages

- Chemical compatibility
- High temperature operation: up to +150°C
- 3 straight versions :
 - Compact type cannot be disassembled
 - 3-piece can be disassembled
 - Light series for more compactness

Component Materials

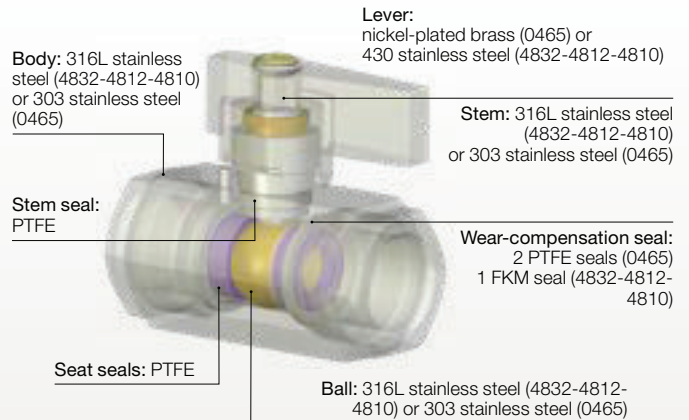

Regulations

- Industrial:
- PED
 - REACH
 - RoHS

Pressure and Temperature Resistance

Version 4810, 4812 and 4832

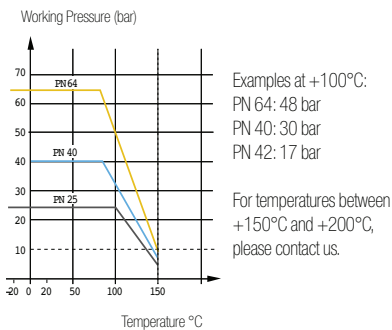

Version 0465

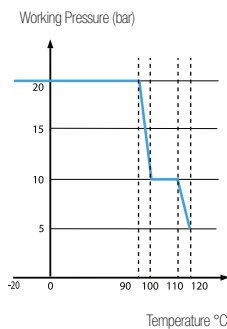

4832 2/2 In-Line 3-Piece Ball Valve with Fixing Plate, Female BSPP Thread

Stainless steel 316L, PTFE

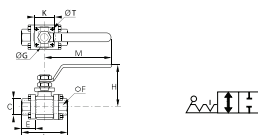

DN	C		E	F	G	H	K	L	M	T	Kg
10	G1/4	4832 10 13**	18	22	36	50	36	57	110.5	5.5	0.272
15	G1/2	4832 15 21	20.5	27	36	64	36	65	131.5	6	0.478
20	G3/4	4832 20 27	22.5	32	42	68	42	76	131.5	5.5	0.568
25	G1	4832 25 34	27	41	42	78.5	42	92	174.5	6	1.229
32	G1 1/4	4832 32 42*	30	50	42	83.5	42	106.5	174.5	5.5	1.530
40	G1 1/2	4832 40 49*	31	55	50	100	50	116	250.5	6.5	2.146
50	G2	4832 50 48*	36	70	50	107	50	136	250.5	6.5	3.140

*Models with EC marking
 ** Without Fixing Plate

4812 2/2 In-Line Ball Valve with Fixing Plate, Female BSPP Thread

Stainless steel 316L, PTFE

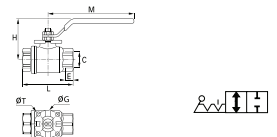

DN	C		E	G	H	L	M	T	Kg
10	G1/4	4812 10 13	10	36	50	55	110	5.5	0.263
	G3/8	4812 10 17	11	36	50	55	110	5.5	0.254
15	G1/2	4812 15 21	15	36	53	66	110	5.5	0.336
20	G3/4	4812 20 27	16	42	67	79	130	5.5	0.574
25	G1	4812 25 34	19	42	79	93	175	5.5	1.010
32	G1 1/4	4812 32 42*	21	42	83	100	175	5.5	1.337
40	G1 1/2	4812 40 49*	21	50	100	110	250	5.5	2.161
50	G2	4812 50 48*	26	70	107	131	250	8.5	3.262

*Models with EC marking

4810 2/2 In-Line Ball Valve, Female BSPP Thread

Stainless steel 316L, PTFE

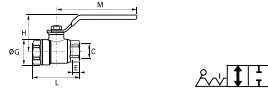

DN	C		E	G	H	L	M	Kg
8	G1/4	4810 08 13	10	30	44.5	53.5	110.5	0.206
10	G3/8	4810 10 17	10	30	44.5	53.5	110.5	0.190
15	G1/2	4810 15 21	13	32.5	47	60	110.5	0.245
20	G3/4	4810 20 27	14	40	54.5	70	131.5	0.418
25	G1	4810 25 34	17	49	58.5	79	131.5	0.648

0465 2/2 In-Line Light Series Ball Valve, Female BSPP Thread

Stainless steel 303, PTFE

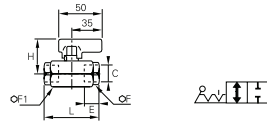

DN	C		E	F	F1	H	L	Kg
4	G1/4	0465 04 13	13	19	24	36	50	0.226
7	G3/8	0465 07 17	13	24	27	39	55	0.278
10	G1/2	0465 10 21	16	27	30	40	62	0.322

Silicone-free

High Pressure Series



Designed for applications up to 300 bar, these carefully manufactured ball valves guarantee safe operation.

Technical Characteristics

- **Compatible Fluids:** Compressed air, lubricants, gases
- **Working Pressure:** Vacuum to 300 bar
- **Working Temperature:** -15°C to +80°C

Reliable performance is dependent upon the type of fluid conveyed, component materials and tubing being used.

Guaranteed for use with a vacuum of 755 mm Hg (99% vacuum).

Advantages

- Low operating torque, even at high pressure
- Repositionable and exchangeable handles
- Robust design resistant to high tightening torques
- Fixing screws for through-bulkhead mounting

Component Materials

Silicone-free

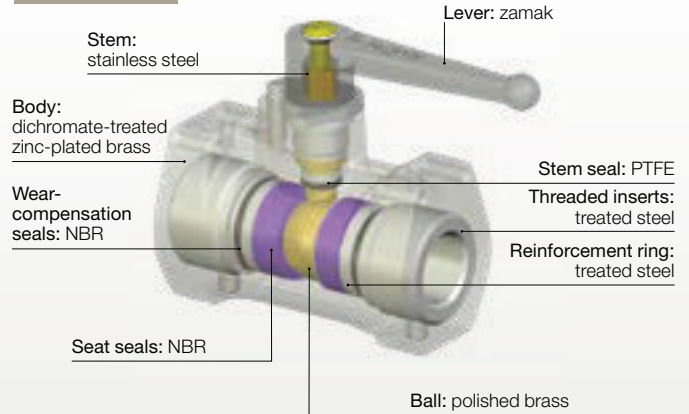

Regulations

- PED
- REACH
- RoHS

Installation Options

Bulkhead Mounting

Through bulkhead with screws

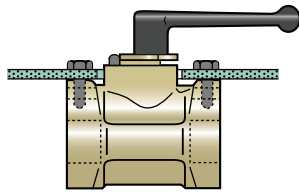

Surface Mounting

With brackets and screws

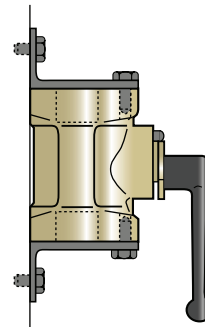

4402 2/2 In-Line High Pressure Ball Valve, Female BSP Thread

Treated brass, NBR

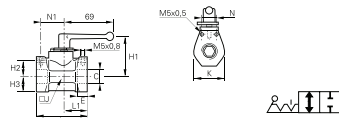

DN	C	E	H1	H2	H3	J	K	L	L1	N	N1	Kg
7	G1/4	4402 07 13	12	50	13	15	30	30	58	25	15	0.402
10	G3/8	4402 10 17	12	54	23	19	36	39	72	36	20	0.722
13	G1/2	4402 13 21	15	56	23	21	40	42	79	36	20	0.870

Mini Series



Equipped with push-in connections and a technical polymer body, this series combines lightness on the equipment, speed of installation.

Technical Characteristics

- **Compatible Fluids:** Compressed air, neutral gases
- **Working Pressure:** Vacuum to 10 bar
- **Working Temperature:** -20°C to +80°C

Tightening Torques	Threads	G1/8	G1/4	G3/8	G1/2
	daN.m	0.8	1.2	3	3.5

Reliable performance is dependent upon the type of fluid conveyed, component materials and tubing being used.

Guaranteed for use with a vacuum of 755 mm Hg (99 % vacuum).

Advantages

- Lightweight and compact
- LF 3000® push-in connections, static and dynamic sealing
- Automatic seal wear compensation for long-term reliability
- Ultra-compact handle, easy operation, screwdriver slot for difficult access

Installation Options

Vented Valve, Open Position

3/2 model with vent

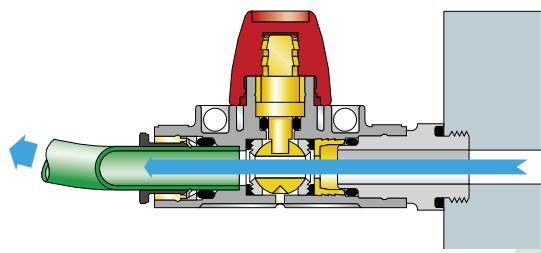

Vented Valve, Closed Position

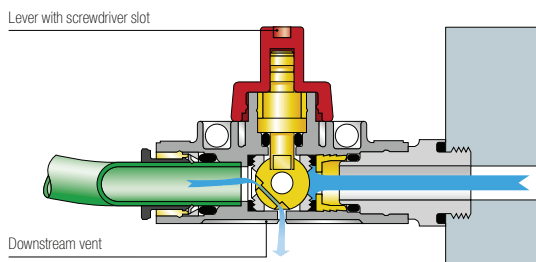

Component Materials

Silicone-free

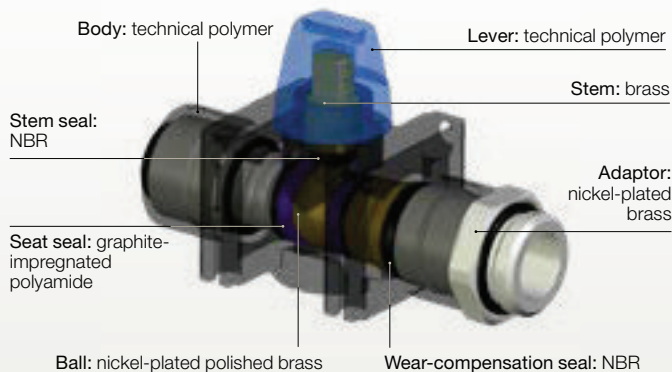

7910 2/2 In-Line Mini-Ball Valve

Technical polymer, NBR

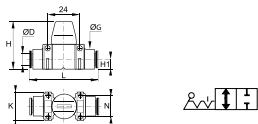

ØD		G	H	H1	K	L	N	Kg
4	7910 04 00	15	37	7.5	22	51	16	0.039
6	7910 06 00	15	37	7.5	22	52	16	0.034
8	7910 08 00	15	37	7.5	22	52	16	0.025
10	7910 10 00	20	43	11	30	66	22	0.060
12	7910 12 00	20	43	11	30	66	22	0.040

7911 2/2 In-Line Mini-Ball Valve, Male BSPP Thread

Technical polymer, Nickel-plated brass, NBR

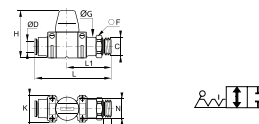

ØD	C		E	F	G	H	K	L	L1	N	Kg
6	G1/8	7911 06 10	5	13	14	37	22	62	37	16	0.045
8	G1/4	7911 08 13	5.5	16	17.5	37	22	61	35	16	0.040
10	G3/8	7911 10 17	5.5	20	22	43	30	74	41	22	0.075
12	G1/2	7911 12 21	7.5	24	26	43	30	75	42	22	0.075

7913 3/2 In-Line Mini-Ball Valve with Vent

Technical polymer, NBR

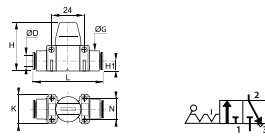

ØD		G	H	H1	K	L	N	Kg
4	7913 04 00	15	37	7.5	22	51	16	0.040
6	7913 06 00	15	37	7.5	22	52	16	0.035
8	7913 08 00	15	37	7.5	22	52	16	0.025
10	7913 10 00	20	43	11	30	66	22	0.060
12	7913 12 00	20	43	11	30	66	22	0.045

7914 3/2 In-Line Mini-Ball Valve with Vent, Male BSPP Thread

Technical polymer, Nickel-plated brass, NBR

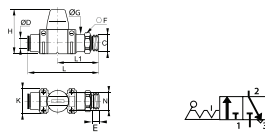

ØD	C		E	F	G	H	K	L	L1	N	Kg
6	G1/8	7914 06 10	5	13	14	37	22	62	37	16	0.045
8	G1/4	7914 08 13	5.5	16	17.5	37	22	61	35	16	0.040
10	G3/8	7914 10 17	5.5	20	22	43	30	74	41	22	0.058
12	G1/2	7914 12 21	7.5	24	26	43	30	75	42	22	0.075

7000 Joining Clips

Technical polymer



ØD		Kg
4	7000 00 04	0.001
6-8	7000 00 05	0.005
10-12	7000 00 06	0.001

Complementary Products for Mini Series

LF 3000®

PA Tubing

PU Tubing

Flow Regulators





As an integral part of the LIQUIfit® range, these ball valves are designed for water and beverage handling circuits. FDA, NSF and WQA standards are a guarantee of safety for the health of consumers. These ball valves offer sealing and cleanliness to the equipment.

Technical Characteristics

- **Compatible Fluids:** Water, drinks, beverages, industrial water, CO₂, inert gases
- **Working Pressure:** 0 to 10 bar at 20°C
- **Working Temperature:** -15°C to +100°C

Advantages

- Technical polymer body
- Full flow self-sealing ball maintains the cleanliness of the circuit
- LIQUIfit® push-in connection, static and dynamic sealing. No pumping effect. Resistant to water hammer.

Regulations

- **FDA: 21 CFR**
- **NSF 51**

Component Materials

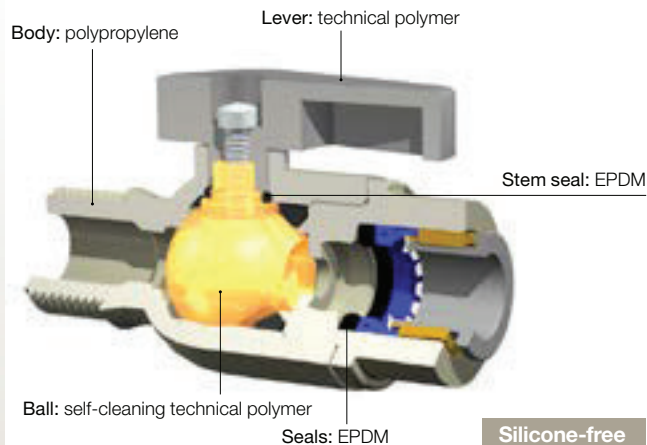

4020 In-Line Ball Valve

Polypropylene with fibreglass, EPDM

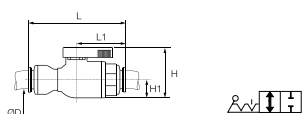

ØD			H	H1	L	L1	Kg
6	4020 06 00WP2		36	13	57	27	0.019
8	4020 08 00WP2		36	13	60	27	0.020
10	4020 10 00WP2		36	13	70	33	0.023
12	4020 12 00WP2		36.5	13	88	43	0.034

4023 2/2 In-Line Ball Valve, Female NPTF Thread Inch

Polypropylene with fibreglass, EPDM

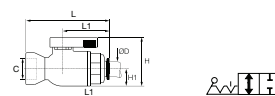

ØD	C		H	H1	L	L1	Kg
3/8	NPTF3/8	4023 60 18WP2	36	13	64	33.5	0.028

4020 2/2 In-Line Ball Valve Inch

Polypropylene with fibreglass, EPDM

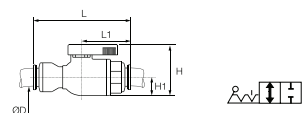

ØD			H	H1	L	L1	Kg
1/4	4020 56 00WP2		36	13	57	27	0.015
3/8	4020 60 00WP2		36	13	70	33	0.028

4022 2/2 Right-Angled Ball Valve, Female NPTF Thread Inch

Polypropylene with fibreglass, EPDM

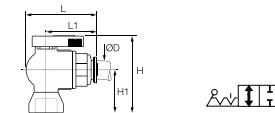

ØD	C		H	H1	L	L1	Kg
1/4	NPTF1/4	4022 56 14WP2	52	29	44	31	0.016

4021 2/2 In-Line Ball Valve, Male NPTF Thread Inch

Polypropylene with fibreglass, EPDM

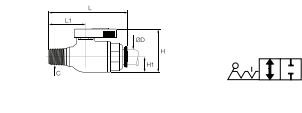

ØD	C		H	H1	L	L1	Kg
1/4	NPTF1/4	4021 56 14WP2	36	13	61	31	0.029
3/8	NPTF3/8	4021 60 18WP2	36	13	64	33.5	0.028

4024 2/2 Right-Angled Ball Valve

Polypropylene with fibreglass, EPDM

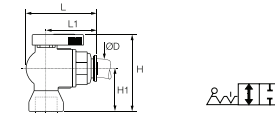

ØD			H	H1	L	L1	Kg
6	4024 06 00WP2		54	31	41	27	0.020
10	4024 10 00WP2		61	38	47	33	0.024

Needle Valves



Made of nickel-plated brass or stainless steel, the needle valves are designed for applications that require manual flow adjustment.

Technical Characteristics

	Brass	Stainless Steel
Compatible Fluids	Compressed air, water, industrial fluids, etc. Other fluids: contact us	Many fluids
Working Pressure	0 to 120 bar	0 to 400 bar
Working Temperature	-20°C to +100°C (except model 0510)	-20°C to +180°C

Reliable performance is dependent upon the type of fluid conveyed.

Advantages

- Manual flow adjustment
- Numerous valve and safety accessory configurations

Component Materials

Silicone-free

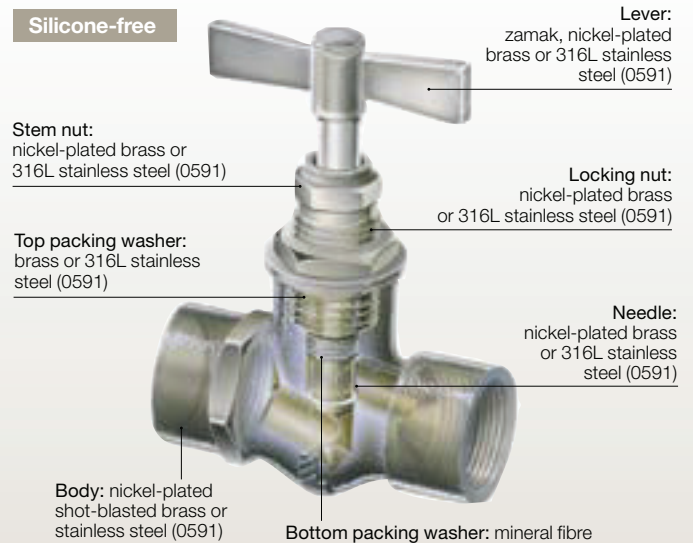

Regulations

- PED
- REACH
- RoHS

0502 In-Line Needle Valve, Female BSP Thread

Nickel-plated brass

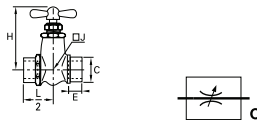

DN	C		E	H	H max	J	L/2	Kg
4	G1/8	0502 04 10	9	56	50	17	23	0.133
	G1/4	0502 04 13	11	56	50	17	23	0.120
6	G3/8	0502 06 17	12	67	60	26	0.171	
9	G3/8	0502 09 17	12	82	70	33	0.426	

0510 In-Line Needle Valve with Compression Connections

Nickel-plated brass

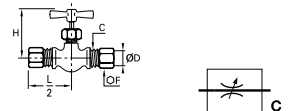

DN	ØD	C		F	H min	H max	L/2	Kg
4	6	M10x1	0510 04 06	13	42	46	29	0.083
8	8	M12x1	0510 05 08	14	42	46	30	0.083
5	10	M16x1.5	0510 05 10	19	42	46	31	0.134

The needle is sealed by an O-ring.
Maximum operating pressure: Ø4: 100 bar, Ø5: 60 bar
Working temperature: -15°C to +70°C
Tightening torques: please refer to the Compression Fittings chapter of this catalogue.

0501 In-Line Needle Valve, Male/Female BSP Thread

Nickel-plated brass

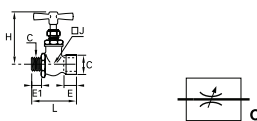

DN	C		E	E1	H	H max	J	L	Kg
4	G1/8	0501 04 10	9	7	56	50	17	44	0.118
	G1/4	0501 04 13	11	9.5	56	50	17	46	0.115
6	G3/8	0501 06 17	12	9.5	67	60	48	0.158	

0532 Right-Angle Needle Valve, Female BSP Thread

Nickel-plated brass

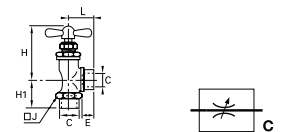

DN	C		E	H min	H max	H1	J	L	Kg
4	G1/8	0532 04 10	9	46	52	46	19	17	0.093
	G1/4	0532 04 13	11	46	52	46	21	17	0.087
6	G1/4	0532 06 13	11	55	63	55	26	22	0.171

0531 Right-Angle Needle Valve, Male/Female BSPP Thread

Nickel-plated brass

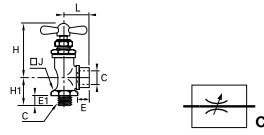

DN	C	E	E1	H min	H max	H1	J	L	Kg	
4	G1/8 0531 04 10	7	9	46	52	46	19	17	19	0.082
	G1/4 0531 04 13	9.5	11	46	52	46	21	17	21	0.090
6	G1/4 0531 06 13	9.5	11	55	63	55	25	22	26	0.155
	G3/8 0531 06 17	9.5	12	55	63	55	25	22	27	0.153
10	G1/2 0531 10 21	13	16	62	72	62	34	26	33	0.329

0562 Needle Drain Valve, Male BSPP and Metric Thread

Brass



DN	C	E	F	H min	H max	Kg
5	G1/8 0562 05 10	8	16	36	40	0.032
	G1/4 0562 05 13	10	19	38.5	42.5	0.040
	M10x1 0562 05 60	8	16	37.5	40	0.031

0563 Needle Drain Valve, BSPT Thread

Brass



DN	C	F	H min	H max	Kg
5	R1/4 0563 05 14	14	28.5	32.5	0.021

0627 Automatic Vent Pressure Gauge Valve, Female BSPP Thread

Nickel-plated brass, NBR

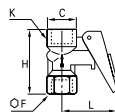

C	F	H	K	L	Kg
G1/4 0627 00 13	19	43.5	20	40	0.097

Pressure: 10 bar

This isolating valve is used to connect a pressure gauge to a circuit.

Resetting the lever isolates and vents the gauge.

A locking pin can be used to enable the gauge to be fitted permanently.

0630 Pressure Relief Valve, Male BSPP Thread

Brass

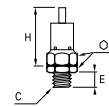

C	E	F	H	Kg
G1/4 0630 06 13	9	17	42.5	0.050

This valve is delivered without calibration, but can be adjusted by inserting metal washers into the hexagon (F).

Maximum working pressure: 10 bar

Calibration from 1 to 10 bar (not below)

0591 Needle Valve, Female BSPP Thread

Stainless steel 316L, PTFE

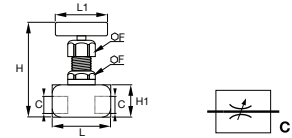

DN	C	F	H min	H max	H1	L	L1	Kg
3	G1/8 0591 03 10	22	90	99	90	25	45	0.342
4	G1/4 0591 04 13	22	90	99	90	25	50	0.354
5	G3/8 0591 05 17	22	90	104	90	30	56	0.430
6	G1/2 0591 06 21	22	90	104	90	30	62	0.478

Butterfly Valves



..... The butterfly valve allows frequent operation with very low torque on circuits without retention zones.

Technical Characteristics

- **Compatible Fluids:** Compressed air, abrasive fluids
- **Working Pressure:** 0 to 16 bar
- **Working Temperature:** -20°C to +80°C

Reliable performance is dependent upon the type of fluid conveyed.

Advantages

- Compatible with abrasive fluids (including solid particles)
- Fluid flow direction marked (uni-directional)
- Small size
- Simple and efficient design

Component Materials

Silicone-free

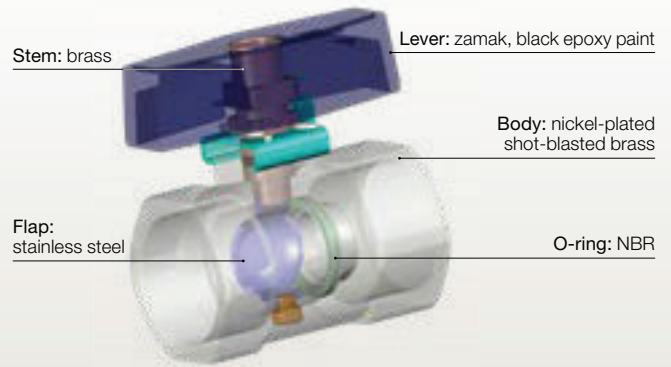

Regulations

- PED
- REACH
- RoHS

4602 2/2 Butterfly Shut-Off Valve, Female BSPP Thread

Nickel-plated brass, NBR

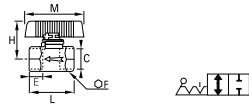

DN	C		E	F	H	L	M	Kg
6	G1/4	4602 06 13	9	17	35	34	54	0.102
7	G3/8	4602 07 17	11	22	35	39	54	0.136
10	G1/2	4602 10 21	12	24	37	42	54	0.140
13	G3/4	4602 13 27	14	30	40	49	54	0.208
18	G1	4602 18 34	15	41	46	55	54	0.412

Axial Valves



This valve is equipped with a pneumatic or electro-pneumatic actuator, so it can be integrated into simple automated systems.

Technical Characteristics

- **Compatible Fluids:** Compressed air, water, industrial fluids...
Other fluids: please consult us
- **Working Pressure:** 10 bar max.
- **Pilot Pressure:** NC and NO: 4.2 to 8 bar
Double-acting: 3 to 8 bar
- **Working Temperature:** -20°C to +150°C (suffix 20 FKM)
-20°C to +150°C (suffix 30 EPDM)

Reliable performance is dependent upon the type of fluid conveyed, component materials and tubing being used.

Guaranteed for use with a vacuum of 740 mm Hg (97% vacuum).

Advantages

- Very compact
- Simple to install: ready-to-use
- Two seal materials (FKM, EPDM) for a wider chemical and temperature range
- Pneumatic or electro-pneumatic
- Three versions: normally closed, normally open and double-acting

Regulations

- PED
- REACH
- RoHS

Component Materials

Silicone-free

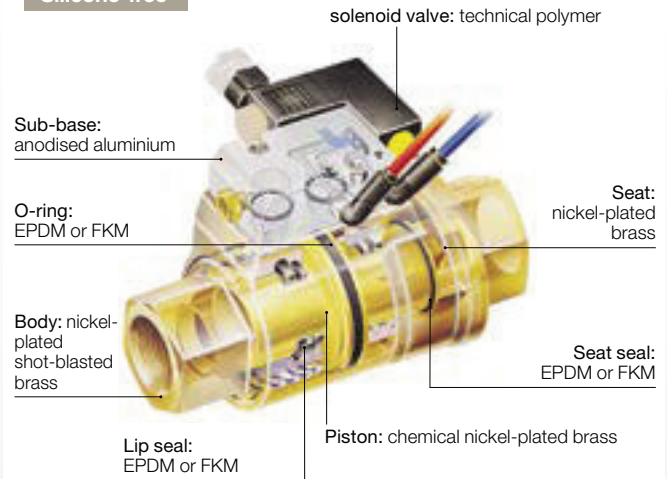

Flow Curve and Pressure Drop (Kv)

Kv in m³/h (ambient water temperature, under a differential pressure of 1 bar)

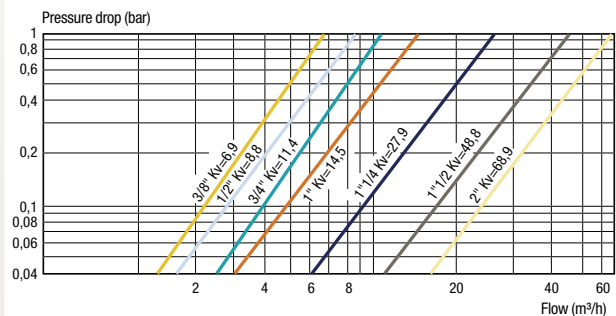

Operation

Depending on operational requirement, air is passed into the actuation chamber to open or close the valve.

Normally Closed Axial Valve (NC)

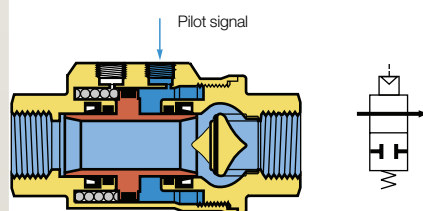
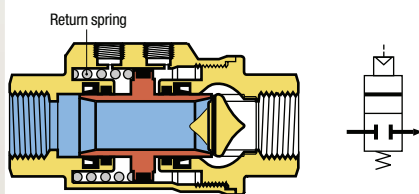

Normally Open Axial Valve (NO)

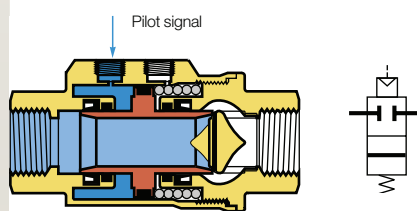
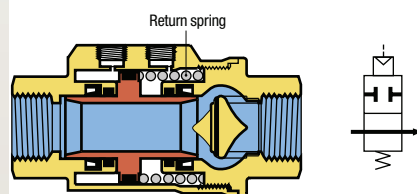

Double-Acting Axial Valve (DA)

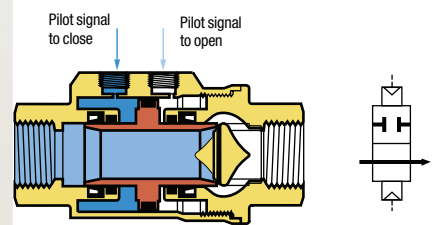

Installation Options

The Parker Legris axial valve offers 3 different control methods dependant on the requirements of the installation:

Pneumatic Control

Example: Double-acting axial valve 4222

- local compressed air control
- for repetitive on/off cycles
- remote control where access to the machine is difficult
- for explosive or explosion prevention areas

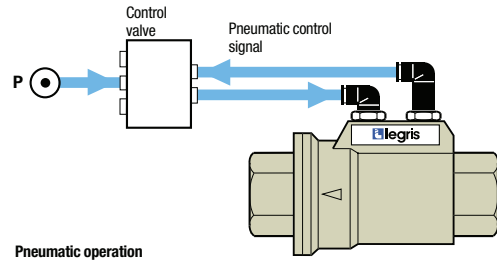

Pneumatic operation

Electro-Pneumatic Control

Example: Normally closed axial valve 4202 + sub-base and Mini-solenoid valve 4298

- for automated industrial systems requiring remote control
- Namur seating plane solenoid valve

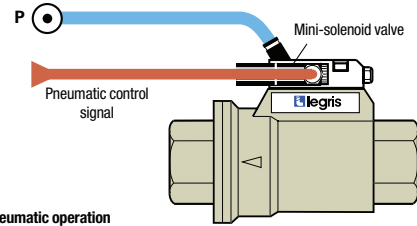

Electro-pneumatic operation

Dual Pneumatic and Electro-Pneumatic Control

Example: Normally open axial valve 4212 + sub-base and Mini-solenoid valve 4298 + Pneumatic push-button 4299

- dual control structure
- for increased safety: prevents localised operating errors
- Namur seating plane solenoid valve

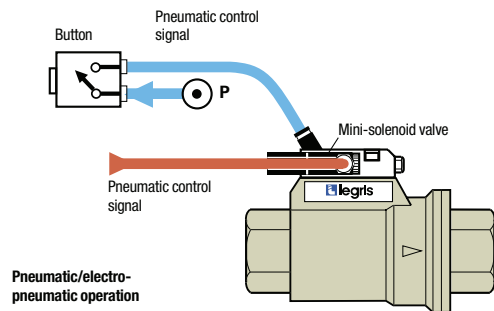

Pneumatic/electro-pneumatic operation

4202..20 Normally Closed Axial Valve with FKM Seal, Female BSPP Thread

Nickel-plated brass, FKM

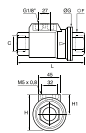

C		F	G	H	H1	L	Kg
G3/8	4202 10 17 20	22	46	54	31	98	0.834
G1/2	4202 15 21 20	27	52	60	35	112	1.075
G3/4	4202 20 27 20	33	64	70	38	135	1.624
G3/4	4202 20 27 30	33	64	70	38	135	1.606
G1	4202 25 34 20	41	69	76	41.5	143	2.033
G1 1/4	4202 32 42 20*	50	86	91	48	165	3.266
G1 1/2	4202 40 49 20*	60	96	102	54	180	4.195
G2	4202 50 48 20*	75	109	115	60.5	207	6.465

Pilot port: G1/8

Delivered with a silencer

*Models with EC marking

4202..30 Normally Closed Axial Valve with EPDM seal, Female BSPP Thread

Nickel-plated brass, EPDM

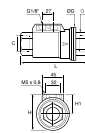

C		F	G	H	H1	L	Kg
G3/8	4202 10 17 30	22	46	54	31	98	0.818
G1/2	4202 15 21 30	27	52	60	35	112	1.071
G1	4202 25 34 30	41	69	76	41.5	143	2.013
G1 1/4	4202 32 42 30*	50	86	91	48	165	3.315
G1 1/2	4202 40 49 30*	60	96	102	54	180	4.195
G2	4202 50 48 30*	75	109	115	60.5	207	6.360

Pilot port: G1/8

Delivered with a silencer

*Models with EC marking

4212..20 Normally Open Axial Valve with FKM Seal, Female BSP Thread

Nickel-plated brass, FKM

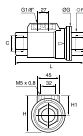

C		F	G	H	H1	L	Kg
G3/8	4212 10 17 20	22	46	54	31	98	0.824
G1/2	4212 15 21 20	27	52	60	35	112	1.096
G3/4	4212 20 27 20	33	64	70	38	135	1.637
G1	4212 25 34 20	41	69	76	41.5	143	2.025
G1 1/2	4212 40 49 20*	60	96	102	54	180	4.188
G2	4212 50 48 20*	75	109	115	60.5	207	6.555

Pilot port: G1/8
Delivered with a silencer
*Models with EC marking

4222..20 Double-Acting Axial Valve with FKM Seal, Female BSP Thread

Nickel-plated brass, FKM

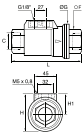

C		F	G	H	H1	L	Kg
G3/8	4222 10 17 20	22	46	54	31	98	0.802
G1/2	4222 15 21 20	27	52	60	35	112	1.042
G3/4	4222 20 27 20	33	64	70	38	135	1.571
G1	4222 25 34 20	41	69	76	41.5	143	1.942
G1 1/2	4222 40 49 20*	60	96	102	54	180	3.995
G2	4222 50 48 20*	75	109	115	60.5	207	6.275

Pilot port: G1/8
*Models with EC marking

4222..30 Double Acting Axial Valve with EPDM seal, Female BSP Thread

Nickel-plated brass, EPDM

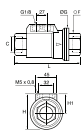

C		F	G	H	H1	L	Kg
G1/2	4222 15 21 30	27	52	60	35	112	1.046
G1 1/4	4222 32 42 30*	50	86	91	48	165	3.301

Pilot port: G1/8
*Models with EC marking

4298 Sub-Base for Solenoid Pilot Valve

Treated aluminium, NBR

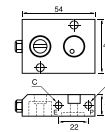

C		Kg
M5x0.8	4298 00 01	0.095

The sub-base is fitted directly to the axial valve and allows the mounting of a 15x15 solenoid valve.
Supplied with 2 fixing bolts, silencer and seats.

4298 Mini-Solenoid Valve 1W/12VA

Anodized aluminium



	Voltage	Kg
4298 01 01	24V = CC*	0.051
4298 01 02	24V ~ CA**	0.058
4298 02 01	110V ~ CA**	0.051
4298 02 02	220V ~ CA**	0.054

*Direct current
**Alternating current

4299 Pneumatic Button

Nickel-plated brass, technical polymer

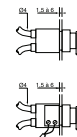

	Contact	Kg
4299 01 01		0.090

Bulkhead fixing hole diameter: Ø22 mm

Fittings, Ball Valves and Accessories Index

Part Number	Page	Part Number	Page	Part Number	Page	Part Number	Page	Part Number	Page	Part Number	Page	Part Number	Page
0101	139	0452	446	1821	175	3204	42	4222..20	465	7000	95	BPLM	159
0101..39	140	0461	447	1822	156	3206	42	4222..30	465	7010	91	BPLM-M	159
0102	144	0462	447	1823	175	3218	42	4298	465	7011	91	BVG4-L	451
0103	142	0465	455	1824	156	3226	42	4299	465	7012	92	BVG4-LOCK	453
0104	144	0469	447	1827	156	3229	41	4402	456	7020	95	BVG4P-LOCK	453
0105	139	0471	446	1843	173	3266	42	4602	462	7030	95	BVG4-C	453
0106	144	0472	445	1844	173	3281	41	4810	455	7031	95	BVG4-L	451
0107	144	0482	446	1845	173	3293	42	4812	454	7040	94	C3BPL	158
0108	142	0483	446	1855	173	3298	41	4832	454	7045	94	C4BPL	158
0109	141	0489	447	1861	174	3299	41	4890	122	7060	92	C8BPL-1	158
0110	145	0490	450	1862	174	3300	36	4891	122	7061	92	CLIP	83
0110..40	146	0491	449	1863	174	3301	176	4892	122	7062	92	COR4BPL	158
0110..60	146	0491..64	449	1864	174	3303	176	4895	122	7065	92	DRV	126
0110..70	146	0492	449	1866	156	3304	29	4902	452	7067	92	EK	160
0111	145	0492..64	449	1867	174	3306	29	4991	452	7100	97	EV	160
0112	148	0494	450	1870	173	3310	29	4992	452	7101	97	F3BPL	157
0114	141	0496	450	1871	173	3311	176	6101	80	7110	97	F4BPL	157
0116	144	0497	450	1872	174	3312	176	6104	81	7111	97	F8BPL	158
0117	168	0501	460	1873	175	3313	176	6105	80	7130	96	FF44	170
0118..39	142	0502	460	207ACBH	169	3320	36	6106	81	7140	96	FG43	170
0119	142	0510	460	207P	169	3321	37	6114	80	7160	96	HBPL	159
0119..39	143	0531	461	209P	170	3329	37	6179	80	7170	98	HP3	179
0120	147	0532	460	216P	171	3379	37	6300	46	7180	97	JBPL	159
0121	170	0562	461	218P	179	3381	37	6302	49	7190	97	MRO434	168
0122	146	0563	461	219P	178	3391	38	6304	49	7300	126	MV	160
0123	171	0591	461	222P	170	3524	35	6306	49	7630	95	R3BPL	158
0124	145	0602	182	3000	70	3527	35	6307	50	7631	95	S3BPL	158
0124..40	145	0605	83	3018	33	3528	35	6315	45	7640	94	WBPL	159
0125	147	0627	461	3091	38	3529	35	6316	51	7649	94		
0126	147	0630	461	3100	25	3538	34	6322	53	7660	93		
0127	148	0669	132	3101	19	3539	34	6325	46	7662	93		
0128..39	148	0670	134	3102	26	3549	34	6326	53	7665	93		
0132	150	0671	134	3103	23	3600	61	6340	50	7668	93		
0133..39	150	0672	134	3104	27	3601	60	6351	54	7669	93		
0134	150	0673	134	3106	26	3602	64	6352	46	7680	97		
0135	176	0674	133	3107	27	3603	62	6355	48	7770	94		
0136	172	0675	134	3108	23	3604	64	6366	53	7771	94		
0137	182	0676	133	3109	20	3606	64	6368	53	7772	94		
0138	81	0677	134	3110	83	3608	62	6380	52	7776	94		
0139	182	0682	134	3113	22	3609	61	6382	52	7800	132		
0142	144	0683	134	3114	20	3614	61	6383	52	7801	132		
0143	168	0900	166	3116	28	3616	65	6388	52	7802	132		
0144	168	0901	166	3118	33	3618	63	6401	445	7810	99		
0145	168	0902	167	3119	34	3620	66	6402	445	7812	99		
0151..39	148	0903	164	3120	31	3621	61	6501	45	7818	128		
0152	168	0904	165	3121	20	3622	66	6503	48	7820	100		
0155	169	0905	165	3122	32	3626	66	6505	45	7822	100		
0158	168	0906	165	3124	34	3629	62	6508	48	7828	128		
0163	169	0907	165	3126	32	3631	61	6509	47	7860	124		
0164	169	0908	164	3129	22	3636	65	6521	46	7870	124		
0165	146	0909	164	3130	82	3639	65	6579	47	7880	112		
0166	145	0910	163	3131	20	3650..33	67	6599	47	7881	112		
0167	169	0911	163	3132	24	3666	66	6801	77	7883	112		
0168	169	0912	163	3133	23	3667	66	6802	78	7885	112		
0168..39	148	0913	163	3136	28	3668	66	6804	78	7886	112		
0169	170	0914	163	3139	28	3669	62	6806	78	7892	114		
0178	164	0915	163	3140	27	3675	60	6814	77	7894	114		
0191	166	0916	163	3142	31	3681	61	6816	79	7899	116		
0192	166	0917	164	3143	31	3693	63	6826	79	7910	457		
0199	142	0919	177	3144	29	3698	63	6840	78	7911	457		
0200	178	0919..1	177	3146	28	3699	62	6866	79	7913	458		
0201	178	0920	165	3148	24	3800	73	6882	79	7914	458		
0202	179	0921	163	3149	34	3801	72	6883	79	7921	130		
0205	178	0927	164	3150..57	40	3802	75	6888	79	7926	130		
0206	180	0928	164	3150..58	40	3804	75	6899	78	7930	119		
0209	178	0929	171	3151	32	3805	71	6901	58	7931	119		
0210	180	0929..1	171	3158	24	3806	75	6903	59	7932	120		
0216	180	0931	166	3159	39	3809	73	6905	58	7960	130		
0220	147	0932	164	3160	39	3816	76	6908	59	7961	130		
0220..39	147	0933	165	3166	31	3821	72	6909	58	7970	115		
0222	177	0934	167	3168	31	3826	76	6911	55	7971	115		
0285	181	0935	167	3169	22	3831	72	6953	57	7984	118		
0400	444	0936	177	3175	18	3866	76	6958	56	7985	118		
0401	445	0950MO	167	3180	30	3879	74	6959	56	7992	121		
0402	445	0950MB	167	3181	19	3889	73	6973	57	7994	118		
0411	444	1802	155	3182	30	3893	74	6974	56	7995	118		
0414	445	1804	155	3183	30	3899	73	6975	55	7996	118		
0432	448	1805	153	3184	30	4020	459	6976	51				
0436	448	1806	155	3188	30	4021	459	6978	57				
0437	448	1809	153	3189	39	4022	459	6979	56				
0438	448	1810	156	3192	22	4023	459	6986	54				
0439	448	1814	153	3193	24	4024	459	6993	59				
0446	445	1816	155	3198	23	4202..20	464	6998	59				
0448	446	1817	173	3199	21	4202..30	464	6999	58				
0449	447	1820	154	3202	42	4212..20	465	7000	458				





Tubing and Blowguns Index

Part Number	Page	Part Number	Page	Part Number	Page
0127	421	1075Y.F	404	AA13	432
0622	433	1080H	417	AA13S-01	432
0623	433	1096Y.F	404	AJ13	428
0631..01	434	1098Y.F	404	AK13	428
0631..05	434	1100H	418	AK13SE	428
0631..07	435	1100P	395	AK26SF	428
0631..09	434	1100P.R	396	AM13	428
0631..23	434	1100P.V	397	AS13	432
0651	429	1100T.P	406	AV13	432
0652	429	1100U	398	CLIP	421
0653	429	1100U..R	399	DK	423
0654	429	1100U..A	400	DS	423
0656	429	1100U..K	402	DV	423
0659	428	1100U..V	401	GI	423
0690 01	430	1100Y	404	GT	422
0690 02	430	1420U	407	KB	424
0690 03	430	1445U..R	413	KN	423
0690 04	430	1460U	413	PG../30	420
0690 05	430	1461U	413	PG../60	420
0690 06	430	1462U	413	PG../75	420
0690 06 01	430	1470P	408	PU../030	414
0690 07	430	1470U	412	PU../060	414
0690 08	431	1471P	408	PU../075	414
0690 09	431	1471U	413	PVC../050	416
0690 10	431	1472P	409	SM	423
0690 11	431	1472U	413	SP../025	409
0694	414	1827	421	SP../025/DV	410
0695	414	2003U	399	SP../025/K+S	411
0697	421	2003U..R	399	SP../050	409
1005T	405	2005P	395	SP../050/DV	410
1010P..M	407	2005U	399	SP../050/K+S	411
1010T..A	406	2005U..R	399	SP../075	409
1015Y..F	403	2010P	395	SP../075/DV	410
1025L	395	2010U	399	SP../075/K+S	411
1025P	394	2010U..R	399	SP../100	409
1025P..V	397	2299	433	SP../100/DV	410
1025T	405	3000 71 00	421	SP../100/K+S	411
1025U	398	3000 71 11	421	SP../150	409
1025U..K	402	6000 71 00	397	SP../150/DV	410
1025U..R	399			SP../150/K+S	411
1025U..V	401			SP../225	409
1025V	416			SP../225/DV	410
1025V..C	416			SP../225/K+S	411
1030Y..F	403			STD	422
1040H	417			STP	422
1050P..M	407			SU../25	420
1050T..P	406			SV	423
1050V	416			UR/UL	422

Couplers index

	Profile	DN	Series	 KF	 KA	 KB	 KL	Plugs
Brass / Steel		1,5	Series 02		P. 200			Series 02
		2	Mini Series		P. 202	P. 203		Mini Series
	German	2,5	Series 50		P. 204			Series 50
	EURO	2,7	Series 20		P. 206	P. 208		Series 20
		3	Mini Series	P. 211				Mini Series
		5	Standard Series		P. 212			Standard Series
	British	5	Series 17		P. 214			Series 17
	EURO	5	Series 21		P. 216	P. 219	P. 222	Series 21
	ARO	5,5	Series 14		P. 225			Series 22
	ISO C	5,5	Series 18		P. 227			Series 18
	British	5,5	Series 19		P. 229			Series 19
	ARO	5,5	Series 22		P. 231			Series 22
	ISO B	5,5	Series 24		P. 233			Series 23
	ISO B	5,5	Series 23		P. 235			Series 23
	ISO B	5,5	Series 1400		P. 237			Series 23
	German	6	Series 52		P. 239	P. 239		Series 52
	EURO	7,2	Series 26		P. 241	P. 243		Series 25/26
	Japanese	7,5	Series 13		P. 245			Series 13
	EURO	7,8	Series 25		P. 247	P. 249		Series 25
	EURO	7,8	Series 1600		P. 251			Series 25
	EURO	7,8	Series 1625		P. 253			Series 25
	Scandinavian	8	Series 33		P. 255			Series 33
	ISO B	8,5	Series 30		P. 257			Series 30
	ARO	9	Series 40		P. 259			Series 40
	EURO	10	Series 27		P. 260	P. 261		Series 27
	EURO	10	Series 1700		P. 263			Series 27
	EURO	10	Series 1727		P. 265			Series 27
	Scandinavian	10	Series 34		P. 267			Series 34
	various	10	Series 41	P. 269				Series 41
	ISO B	11	Series 37		P. 271			Series 37
	German	12	Series 57		P. 273	P. 273		Series 57
	American	15	Series 38		P. 275	P. 275		Series 38
American	19	Series 39		P. 277	P. 277	P. 278	Series 39	
ISO 7241-1 B	4,3-20	Series 70			P. 280		Series 70	
Stainless Steel	EURO	2,7	Series 20		P. 281	P. 282		Series 20
	ISO C	3	Series 303			P. 284		Series 303
	EURO	5	Series 21		P. 286	P. 288		Series 21
	EURO	7,4	Series 25		P. 290	P. 291		Series 25
	EURO	10	Series 27		P. 293	P. 294		Series 27
	ISO 7241-1 B	4,3-20	Series 70			P. 296		Series 70

Couplers index

		Profile	DN	Series	 KF	 KA	 KB	 KL	Plugs
Thermo-plastic			5	Series 21		P. 297	P. 297		Series 21
			7	Series 48		P. 303	P. 303		Series 48
			4,3-20	Series 70			P. 307		Series 70
				Components					
Flat sealing			4-9	Series 200KL				P. 309	Series 200
			3-12	Series 200KLEK				P. 311	Series 200KLEK
Safety	Standard		5	Series 21KS		P. 313	P. 314		Series 21
			7,8	Series 25KS		P. 316	P. 317		Series 25
	Breathing Air		7,4	Series 95KS		P. 318			Series 95
			7,4	Series 96KS		P. 320			Series 96
	Self-Venting with Push Button Technology	ISO 6150 C	5,5	Series 18KP		P. 322			Series 18
		ISO 6150 B	5,5	Series 24KP		P. 324			Series 23
		EURO	7,4	Series 26KP		P. 326			Series 25
		ISO 6150 B	8	Series 30KP		P. 328			Series 30
	Self-Venting with Sleeve Technology	ISO 6150 C	8	Series 84KP		P. 330			Series 84
		ARO	5,5	Series 14KE		P. 332			Series 22
		ISO B	5,5	Series 1400KE		P. 334			Series 23
		ISO B	5,5	Series 24KE		P. 336			Series 23
		EURO	7,4	Series 26KE		P. 338			Series 25
		EURO	7,8	Series 1600KE		P. 340			Series 25
		EURO	10	Series 1700KE		P. 342			Series 27
			C 9000		P. 344			C 9000	
Coded Systems			5	Series 21		P. 349	P. 350		Series 21
			7,8	Series 25		P. 352	P. 354		Series 25
Accessories		Components							
Mold		International	6 / 9 / 13	Series 86 / 87 / 88	P. 358	P. 360	P. 360		Series 86/87/88
		International	6 / 9	Series 86 / 87 Safe Lock Technology	P. 363	P. 364	P. 364		Series 86/87/88
		European	6 / 9 / 13	Series 10 / 11 / 12	P. 365	P. 367	P. 367		Series 10/11/12
		European	6 / 9	Series 10 / 11 Safe Lock Technology	P. 370	P. 371	P. 371		Series 10/11/12
		European	6 / 9	Series 10 / 11 Safety Locking Technology	P. 372	P. 373	P. 373		Series 10/11/12
		French	8	Series 608	P. 375				Series 608
		Multi-Matic	8,1	Series 93	P. 377			P. 377	Series 93
		Accessories		Components					
		Hoses							
Water			12	Midi Series	P. 381	P. 381			Midi Series
			19	Maxi Series	P. 384				Maxi Series

Selecting and Using Hose, Tubing, Fittings, Connectors, Conductors, Valves and Related Accessories

WARNING: Failure or improper selection or improper use of hose, tubing, fittings, assemblies, valves, connectors, conductors or related accessories (“Products”) can cause death, personal injury and property damage. Possible consequences of failure or improper selection or improper use of these Products include but are not limited to:

- Fittings thrown off at high speed.
- High velocity fluid discharge.
- Explosion or burning of the conveyed fluid.
- Electrocution from high voltage electric powerlines.
- Contact with suddenly moving or falling objects that are controlled by the conveyed fluid.
- Injections by high-pressure fluid discharge.
- Dangerously whipping Hose.
- Tube or pipe burst.
- Weld joint fracture.
- Contact with conveyed fluids that may be hot, cold, toxic or otherwise injurious.
- Sparking or explosion caused by static electricity buildup or other sources of electricity.
- Sparking or explosion while spraying paint or flammable liquids.
- Injuries resulting from inhalation, ingestion or exposure to fluids.

Before selecting or using any of these Products, it is important that you read and follow the instructions below. No product from any division in Fluid Connector Group is approved for in-flight aerospace applications. For hoses and fittings used in in-flight aerospace applications, please contact Parker Aerospace Group

1.0 GENERAL INSTRUCTIONS

- 1.1 Scope: This safety guide provides instructions for selecting and using (including assembling, installing, and maintaining) these Products. For convenience, all rubber and/or thermoplastic products commonly called “hose” or “tubing” are called “Hose” in this safety guide. Metallic tube or pipe are called “tube”. All assemblies made with Hose are called “Hose Assemblies”. All assemblies made with Tube are called “Tube Assemblies”. All products commonly called “fittings”, “couplings” or “adapters” are called “Fittings”. Valves are fluid system components that control the passage of fluid. Related accessories are ancillary devices that enhance or monitor performance including crimping, flaring, flanging, presetting, bending, cutting, deburring, swaging machines, sensors, tags, lockout handles, spring guards and associated tooling. This safety guide is a supplement to and is to be used with the specific Parker publications for the specific Hose, Fittings and Related Accessories that are being considered for use. Parker publications are available at www.parker.com. SAE J1273 (www.sae.org) and ISO 17165-2 (www.ansi.org) also provide recommended practices for hydraulic Hose Assemblies, and should be followed.
- 1.2 Fail-Safe: Hose, Hose Assemblies, Tube, Tube Assemblies and Fittings can and do fail without warning for many reasons. Design all systems and equipment in a fail-safe mode, so that failure of the Hose, Hose Assembly, Tube, Tube Assembly or Fitting will not endanger persons or property.
- 1.3 Distribution: Provide a copy of this safety guide to each person responsible for selecting or using Hose, Tube and Fitting products. Do not select or use Parker Hose, Tube or Fittings without thoroughly reading and understanding this safety guide as well as the specific Parker publications for the Products.
- 1.4 User Responsibility: Due to the wide variety of operating conditions and applications for Hose, Tube and Fittings. Parker does not represent or warrant that any particular Hose, Tube or Fitting is suitable for any specific end use system. This safety guide does not analyze all technical parameters that must be considered in selecting a product. The user, through its own analysis and testing, is solely responsible for:
 - Making the final selection of the Products.
 - Assuring that the user’s requirements are met and that the application presents no health or safety hazards.
 - Following the safety guide for Related Accessories and being trained to operate Related Accessories.
 - Providing all appropriate health and safety warnings on the equipment on which the Products are used.
 - Assuring compliance with all applicable government and industry standards.
- 1.5 Additional Questions: Call the appropriate Parker technical service

department if you have any questions or require any additional information. See the Parker publication for the Products being considered or used, or call 1-800-CPARKER, or go to www.parker.com, for telephone numbers of the appropriate technical service department.

2.0 HOSE, TUBE AND FITTINGS SELECTION INSTRUCTIONS

- 2.1 Electrical Conductivity: Certain applications require that the Hose be nonconductive to prevent electrical current flow. Other applications require the Hose and the Fittings and the Hose/Fitting interface to be sufficiently conductive to drain off static electricity. Extreme care must be exercised when selecting Hose, Tube and Fittings for these or any other applications in which electrical conductivity or nonconductivity is a factor. The electrical conductivity or nonconductivity of Hose, Tube and Fittings is dependent upon many factors and may be susceptible to change. These factors include but are not limited to the various materials used to make the Hose and the Fittings, Fitting finish (some Fitting finishes are electrically conductive while others are nonconductive), manufacturing methods (including moisture control), how the Fittings contact the Hose, age and amount of deterioration or damage or other changes, moisture content of the Hose at any particular time, and other factors. The following are considerations for electrically nonconductive and conductive Hose. For other applications consult the individual catalog pages and the appropriate industry or regulatory standards for proper selection.
 - 2.1.1 Electrically Nonconductive Hose: Certain applications require that the Hose be nonconductive to prevent electrical current flow or to maintain electrical isolation. For applications that require Hose to be electrically nonconductive, including but not limited to applications near high voltage electric lines, only special nonconductive Hose can be used. The manufacturer of the equipment in which the nonconductive Hose is to be used must be consulted to be certain that the Hose, Tube and Fittings that are selected are proper for the application. Do not use any Parker Hose or Fittings for any such application requiring nonconductive Hose, including but not limited to applications near high voltage electric lines or dense magnetic fields, unless (i) the application is expressly approved in the Parker technical publication for the product, (ii) the Hose is marked “nonconductive”, and (iii) the manufacturer of the equipment on which the Hose is to be used specifically approves the particular Parker Hose, Tube and Fittings for such use.
 - 2.1.2 Electrically Conductive Hose: Parker manufactures special Hose for certain applications that require electrically conductive Hose. Parker manufactures special Hose for conveying paint in airless paint spraying applications. This Hose is labeled “Electrically Conductive Airless Paint Spray Hose” on its layline and packaging. This Hose must be properly connected to the appropriate Parker Fittings and properly grounded in order to dissipate dangerous static charge buildup, which occurs in all airless paint spraying applications. Do not use any other Hose for airless paint spraying, even if electrically conductive. Use of any other Hose or failure to properly connect the Hose can cause a fire or an explosion resulting in death, personal injury, and property damage. All hoses that convey fuels must be grounded. Parker manufactures a special Hose for certain compressed natural gas (“CNG”) applications where static electricity buildup may occur. Parker CNG Hose assemblies comply with the requirements of ANSI/IAS NGV 4.2; CSA 12.52, “Hoses for Natural Gas Vehicles and Dispensing Systems” (www.ansi.org). This Hose is labeled “Electrically Conductive for CNG Use” on its layline and packaging. This Hose must be properly connected to the appropriate Parker Fittings and properly grounded in order to dissipate dangerous static charge buildup, which occurs in, for example, high velocity CNG dispensing or transfer. Do not use any other Hose for CNG applications where static charge buildup may occur, even if electrically conductive. Use of other Hoses in CNG applications or failure to properly connect or ground this Hose can cause a fire or an explosion resulting in death, personal injury, and property damage. Care must also be taken to protect against CNG permeation through the Hose wall. See section 2.6, Permeation, for more information. Parker CNG Hose is intended for dispenser and vehicle use within the specified temperature range. Parker CNG Hose should not be used in confined spaces or unventilated areas or areas exceeding the specified temperature range. Final assemblies must be tested for leaks. CNG Hose Assemblies should be tested on a monthly basis for conductivity per ANSI/IAS NGV 4.2; CSA 12.52. Parker manufactures special Hose for aerospace in-flight applications.

Selecting and Using Hose, Tubing, Fittings, Connectors, Conductors, Valves and Related Accessories

Aerospace in-flight applications employing Hose to transmit fuel, lubricating fluids and hydraulic fluids require a special Hose with a conductive inner tube. This Hose for in-flight applications is available only from Parker's Stratoflex Products Division. Do not use any other Parker Hose for in-flight applications, even if electrically conductive. Use of other Hoses for in-flight applications or failure to properly connect or ground this Hose can cause a fire or an explosion resulting in death, personal injury and property damage. These Hose assemblies for in-flight applications must meet all applicable aerospace industry, aircraft engine and aircraft requirements.

- 2.2 Pressure: Hose, Tube and Fitting selection must be made so that the published maximum working pressure of the Hose, Tube and Fittings are equal to or greater than the maximum system pressure. The maximum working pressure of a Hose, or Tube Assembly is the lower of the respective published maximum working pressures of the Hose, Tube and the Fittings used. Surge pressures or peak transient pressures in the system must be below the published maximum working pressure for the Hose, Tube and Fitting. Surge pressures and peak pressures can usually only be determined by sensitive electrical instrumentation that measures and indicates pressures at millisecond intervals. Mechanical pressure gauges indicate only average pressures and cannot be used to determine surge pressures or peak transient pressures. Published burst pressure ratings for Hose is for manufacturing test purposes only and is no indication that the Product can be used in applications at the burst pressure or otherwise above the published maximum recommended working pressure.
- 2.3 Suction: Hoses used for suction applications must be selected to insure that the Hose will withstand the vacuum and pressure of the system. Improperly selected Hose may collapse in suction application.
- 2.4 Temperature: Be certain that fluid and ambient temperatures, both steady and transient, do not exceed the limitations of the Hose, Tube, Fitting and Seals. Temperatures below and above the recommended limit can degrade Hose, Tube, Fittings and Seals to a point where a failure may occur and release fluid. Tube and Fittings performances are normally degraded at elevated temperature. Material compatibility can also change at temperatures outside of the rated range. Properly insulate and protect the Hose Assembly when routing near hot objects (e.g. manifolds). Do not use any Hose in any application where failure of the Hose could result in the conveyed fluids (or vapors or mist from the conveyed fluids) contacting any open flame, molten metal, or other potential fire ignition source that could cause burning or explosion of the conveyed fluids or vapors.
- 2.5 Fluid Compatibility: Hose, and Tube Assembly selection must assure compatibility of the Hose tube, cover, reinforcement, Tube, Plating and Seals with the fluid media used. See the fluid compatibility chart in the Parker publication for the product being considered or used. This information is offered only as a guide. Actual service life can only be determined by the end user by testing under all extreme conditions and other analysis. Hose, and Tube that is chemically compatible with a particular fluid must be assembled using Fittings and adapters containing likewise compatible seals. Flange or flare processes can change Tube material properties that may not be compatible with certain requirements such as NACE
- 2.6 Permeation: Permeation (that is, seepage through the Hose or Seal) will occur from inside the Hose or Fitting to outside when Hose or Fitting is used with gases, liquid and gas fuels, and refrigerants (including but not limited to such materials as helium, diesel fuel, gasoline, natural gas, or LPG). This permeation may result in high concentrations of vapors which are potentially flammable, explosive, or toxic, and in loss of fluid. Dangerous explosions, fires, and other hazards can result when using the wrong Hose for such applications. The system designer must take into account the fact that this permeation will take place and must not use Hose or Fitting if this permeation could be hazardous. The system designer must take into account all legal, government, insurance, or any other special regulations which govern the use of fuels and refrigerants. Never use a Hose or Fitting even though the fluid compatibility is acceptable without considering the potential hazardous effects that can result from permeation through the Hose or Tube Assembly. Permeation of moisture from outside the Hose or Fitting to inside the Hose or Fitting will also occur in Hose or Tube assemblies, regardless of internal pressure. If this moisture permeation would have detrimental effects (particularly, but not limited to refrigeration and air conditioning systems), incorporation of sufficient drying capacity in the system or other appropriate system safeguards should be selected and used. The sudden pressure release of highly pressurized gas could also result in Explosive Decompression failure of permeated
- Seals and Hoses.
- 2.7 Size: Transmission of power by means of pressurized fluid varies with pressure and rate of flow. The size of the components must be adequate to keep pressure losses to a minimum and avoid damage due to heat generation or excessive fluid velocity.
- 2.8 Routing: Attention must be given to optimum routing to minimize inherent problems (kinking or flow restriction due to Hose collapse, twisting of the Hose, proximity to hot objects or heat sources). For additional routing recommendations see SAE J1273 and ISO 17165-2. Hose Assemblies have a finite life and should be installed in a manner that allows for ease of inspection and future replacement. Hose because of its relative short life, should not be used in residential and commercial buildings inside of inaccessible walls or floors, unless specifically allowed in the product literature. Always review all product literature for proper installation and routing instructions.
- 2.9 Environment: Care must be taken to insure that the Hose, Tube and Fittings are either compatible with or protected from the environment (that is, surrounding conditions) to which they are exposed. Environmental conditions including but not limited to ultraviolet radiation, sunlight, heat, ozone, moisture, water, salt water, chemicals and air pollutants can cause degradation and premature failure.
- 2.10 Mechanical Loads: External forces can significantly reduce Hose, Tube and Fitting life or cause failure. Mechanical loads which must be considered include excessive flexing, twist, kinking, tensile or side loads, bend radius, and vibration. Use of swivel type Fittings or adapters may be required to insure no twist is put into the Hose. Use of proper Hose or Tube clamps may also be required to reduce external mechanical loads. Unusual applications may require special testing prior to Hose selection.
- 2.11 Physical Damage: Care must be taken to protect Hose from wear, snagging, kinking, bending smaller than minimum bend radius and cutting, any of which can cause premature Hose failure. Any Hose that has been kinked or bent to a radius smaller than the minimum bend radius, and any Hose that has been cut or is cracked or is otherwise damaged should be removed and discarded. Fittings with damages such as scratches on sealing surfaces and deformation should be replaced.
- 2.12 Proper End Fitting: See instructions 3.2 through 3.5. These recommendations may be substantiated by testing to industry standards such as SAE J517 for hydraulic applications, or MIL-A-5070, AS1339, or AS3517 for Hoses from Parker's Stratoflex Products Division for aerospace applications.
- 2.13 Length: When determining the proper Hose or Tube length of an assembly take into consideration. The Hose length change due to pressure. The Tube length change due to thermal expansion or contraction, and the Hose or Tube machine tolerances and movements. When routing short hose assemblies, it is recommended that the minimum free hose length is always used. Consult the hose manufacturer for their minimum free hose length recommendations. Hose assemblies should be installed in such a way that any motion or flexing occurs within the same plane.
- 2.14 Specifications and Standards: When selecting Hose, Tube and Fittings, government, industry, and Parker specifications and recommendations must be reviewed and followed as applicable.
- 2.15 Hose Cleanliness: Hose and Tube components may vary in cleanliness levels. Care must be taken to ensure that the Hose and Tube Assembly selected has an adequate level of cleanliness for the application.
- 2.16 Fire Resistant Fluids: Some fire resistant fluids that are to be conveyed by Hose or Tube require use of the same type of Hose or Tube as used with petroleum base fluids. Some such fluids require a special Hose, Tube, Fitting and Seal, while a few fluids will not work with any Hose at all. See instructions 2.5 and 1.5. The wrong Hose, Tube, Fitting or Seal may fail after a very short service. In addition, all liquids but pure water may burn fiercely under certain conditions, and even pure water leakage may be hazardous.
- 2.17 Radiant Heat: Hose and Seals can be heated to destruction without contact by such nearby items as hot manifolds or molten metal. The same heat source may then initiate a fire. This can occur despite the presence of cool air around the Hose or Seal. Performance of Tube and Fitting subjected to the heat could be degraded.
- 2.18 Welding or Brazing: When using a torch or arc welder in close proximity to hydraulic lines, the hydraulic lines should be removed or shielded with appropriate fire resistant materials. Flame or weld spatter could burn through the Hose or Seal and possibly ignite escaping fluid resulting in a catastrophic failure. Heating of plated parts, including Hose Fittings and adapters, above 450°F (232°C) such as during welding, brazing or soldering may emit deadly gases. Any elastomer seal on fittings shall

Selecting and Using Hose, Tubing, Fittings, Connectors, Conductors, Valves and Related Accessories

be removed prior to welding or brazing, any metallic surfaces shall be protected after brazing or welding when necessary. Welding and brazing filler material shall be compatible with the Tube and Fitting that are joined.

- 2.19 Atomic Radiation: Atomic radiation affects all materials used in Hose and Tube assemblies. Since the long-term effects may be unknown, do not expose Hose or Tube assemblies to atomic radiation. Nuclear applications may require special Tube and Fittings.
- 2.20 Aerospace Applications: The only Hose, Tube and Fittings that may be used for in-flight aerospace applications are those available from Parker's Stratoflex Products Division. Do not use any other Hose or Fittings for in-flight applications. Do not use any Hose or Fittings from Parker's Stratoflex Products Division with any other Hose or Fittings, unless expressly approved in writing by the engineering manager or chief engineer of Stratoflex Products Division and verified by the user's own testing and inspection to aerospace industry standards.
- 2.21 Unlocking Couplings: Ball locking couplings or other Fittings with quick disconnect ability can unintentionally disconnect if they are dragged over obstructions, or if the sleeve or other disconnect member, is bumped or moved enough to cause disconnect. Threaded Fittings should be considered where there is a potential for accidental uncoupling.

3.0 HOSE AND FITTINGS ASSEMBLY AND INSTALLATION INSTRUCTIONS

- 3.1 Component Inspection: Prior to assembly, a careful examination of the Hose and Fittings must be performed. All components must be checked for correct style, size, catalog number, and length. The Hose must be examined for cleanliness, obstructions, blisters, cover looseness, kinks, cracks, cuts or any other visible defects. Inspect the Fitting and sealing surfaces for burrs, nicks, corrosion or other imperfections. Do NOT use any component that displays any signs of nonconformance.
- 3.2 Hose and Fitting Assembly: Do not assemble a Parker Fitting on a Parker Hose that is not specifically listed by Parker for that Fitting, unless authorized in writing by the engineering manager or chief engineer of the appropriate Parker division. Do not assemble a Parker Fitting on another manufacturer's Hose or a Parker Hose on another manufacturer's Fitting unless (i) the engineering manager or chief engineer of the appropriate Parker division approves the Assembly in writing or that combination is expressly approved in the appropriate Parker literature for the specific Parker product, and (ii) the user verifies the Assembly and the application through analysis and testing. For Parker Hose that does not specify a Parker Fitting, the user is solely responsible for the selection of the proper Fitting and Hose Assembly procedures. See instruction 1.4. To prevent the possibility of problems such as leakage at the Fitting or system contamination, it is important to completely remove all debris from the cutting operation before installation of the Fittings. The Parker published instructions must be followed for assembling the Fittings on the Hose. These instructions are provided in the Parker Fitting catalog for the specific Parker Fitting being used, or by calling 1-800-CPARKER, or at www.parker.com.
- 3.3 Related Accessories: Do not crimp or swage any Parker Hose or Fitting with anything but the listed swage or crimp machine and dies in accordance with Parker published instructions. Do not crimp or swage another manufacturer's Fitting with a Parker crimp or swage die unless authorized in writing by the engineering manager or chief engineer of the appropriate Parker division. 3.4 Parts: Do not use any Parker Fitting part (including but not limited to socket, shell, nipple, or insert) except with the correct Parker mating parts, in accordance with Parker published instructions, unless authorized in writing by the engineering manager or chief engineer of the appropriate Parker division.
- 3.5 Field Attachable/Permanent: Do not reuse any field attachable Hose Fitting that has blown or pulled off a Hose. Do not reuse a Parker permanent Hose Fitting (crimped or swaged) or any part thereof. Complete Hose Assemblies may only be reused after proper inspection under section 4.0. Do not assemble Fittings to any previously used hydraulic Hose that was in service, for use in a fluid power application.
- 3.6 Pre-Installation Inspection: Prior to installation, a careful examination of the Hose Assembly must be performed. Inspect the Hose Assembly for any damage or defects. DO NOT use any Hose Assembly that displays any signs of nonconformance.
- 3.7 Minimum Bend Radius: Installation of a Hose at less than the minimum listed bend radius may significantly reduce the Hose life. Particular attention must be given to preclude sharp bending at the Hose to Fitting juncture. Any bending during installation at less than the minimum bend

radius must be avoided. If any Hose is kinked during installation, the Hose must be discarded.

- 3.8 Twist Angle and Orientation: Hose Assembly installation must be such that relative motion of machine components does not produce twisting.
- 3.9 Securement: In many applications, it may be necessary to restrain, protect, or guide the Hose to protect it from damage by unnecessary flexing, pressure surges, and contact with other mechanical components. Care must be taken to insure such restraints do not introduce additional stress or wear points.
- 3.10 Proper Connection of Ports: Proper physical installation of the Hose Assembly requires a correctly installed port connection insuring that no twist or torque is transferred to the Hose when the Fittings are being tightened or otherwise during use.
- 3.11 External Damage: Proper installation is not complete without insuring that tensile loads, side loads, kinking, flattening, potential abrasion, thread damage or damage to sealing surfaces are corrected or eliminated. See instruction 2.10.
- 3.12 System Checkout: All air entrapment must be eliminated and the system pressurized to the maximum system pressure (at or below the Hose maximum working pressure) and checked for proper function and freedom from leaks. Personnel must stay out of potential hazardous areas while testing and using.
- 3.13 Routing: The Hose Assembly should be routed in such a manner so if a failure does occur, the escaping media will not cause personal injury or property damage. In addition, if fluid media comes in contact with hot surfaces, open flame or sparks, a fire or explosion may occur. See section 2.4.
- 3.14 Ground Fault Equipment Protection Devices (GFEPDs): WARNING! Fire and Shock Hazard. To minimize the danger of fire if the heating cable of a Multitube bundle is damaged or improperly installed, use a Ground Fault Equipment Protection Device. Electrical fault currents may be insufficient to trip a conventional circuit breaker. For ground fault protection, the IEEE 515: (www.ansi.org) standard for heating cables recommends the use of GFEPDs with a nominal 30 milliampere trip level for "piping systems in classified areas, those areas requiring a high degree of maintenance, or which may be exposed to physical abuse or corrosive atmospheres".

4.0 TUBE AND FITTINGS ASSEMBLY AND INSTALLATION INSTRUCTIONS

- 4.1 Component Inspection: Prior to assembly, a careful examination of the Tube and Fittings must be performed. All components must be checked for correct style, size, material, seal, and length. Inspect the Fitting and sealing surfaces for burrs, nicks, corrosion, missing seal or other imperfections. Do NOT use any component that displays any signs of nonconformance.
- 4.2 Tube and Fitting Assembly: Do not assemble a Parker Fitting with a Tube that is not specifically listed by Parker for that Fitting, unless authorized in writing by the engineering manager or chief engineer of the appropriate Parker division. The Tube must meet the requirements specified to the Fitting. The Parker published instructions must be followed for assembling the Fittings to a Tube. These instructions are provided in the Parker Fitting catalog for the specific Parker Fitting being used, or by calling 1-800-CPARKER, or at www.parker.com.
- 4.3 Related Accessories: Do not preset or flange Parker Fitting components using another manufacturer's equipment or procedures unless authorized in writing by the engineering manager or chief engineer of the appropriate Parker division. Tube, Fitting component and tooling must be checked for correct style, size and material. Operation and maintenance of Related Accessories must be in accordance with the operation manual for the designated Accessory.
- 4.4 Securement: In many applications, it may be necessary to restrain, protect, or guide the Tube to protect it from damage by unnecessary flexing, pressure surges, vibration, and contact with other mechanical components. Care must be taken to insure such restraints do not introduce additional stress or wear points.
- 4.5 Proper Connection of Ports: Proper physical installation of the Tube Assembly requires a correctly installed port connection insuring that no torque is transferred to the Tube when the Fittings are being tightened or otherwise during use.
- 4.6 External Damage: Proper installation is not complete without insuring that tensile loads, side loads, flattening, potential abrasion, thread damage or damage to sealing surfaces are corrected or eliminated. See instruction

Selecting and Using Hose, Tubing, Fittings, Connectors, Conductors, Valves and Related Accessories

2.10.

- 4.7 System Checkout: All air entrapment must be eliminated and the system pressurized to the maximum system pressure (at or below the Tube Assembly maximum working pressure) and checked for proper function and freedom from leaks. Personnel must stay out of potential hazardous areas while testing and using.
- 4.8 Routing: The Tube Assembly should be routed in such a manner so if a failure does occur, the escaping media will not cause personal injury or property damage. In addition, if fluid media comes in contact with hot surfaces, open flame or sparks, a fire or explosion may occur. See section 2.4.

5.0 HOSE AND FITTING MAINTENANCE AND REPLACEMENT INSTRUCTIONS

- 5.1 Even with proper selection and installation, Hose life may be significantly reduced without a continuing maintenance program. The severity of the application, risk potential from a possible Hose failure, and experience with any Hose failures in the application or in similar applications should determine the frequency of the inspection and the replacement of the Products so that Products are replaced before any failure occurs. Certain products require maintenance and inspection per industry requirements. Failure to adhere to these requirements may lead to premature failure. A maintenance program must be established and followed by the user and, at minimum, must include instructions 5.2 through 5.7
- 5.2 Visual Inspection Hose/Fitting: Any of the following conditions require immediate shut down and replacement of the Hose Assembly:
- Fitting slippage on Hose;
 - Damaged, cracked, cut or abraded cover (any reinforcement exposed);
 - Hard, stiff, heat cracked, or charred Hose;
 - Cracked, damaged, or badly corroded Fittings;
 - Leaks at Fitting or in Hose;
 - Kinked, crushed, flattened or twisted Hose; and
 - Blistered, soft, degraded, or loose cover.
- 5.3 Visual Inspection All Other: The following items must be tightened, repaired, corrected or replaced as required:
- Leaking port conditions;
 - Excess dirt buildup;
 - Worn clamps, guards or shields; and
 - System fluid level, fluid type, and any air entrapment.
- 5.4 Functional Test: Operate the system at maximum operating pressure and check for possible malfunctions and leaks. Personnel must avoid potential hazardous areas while testing and using the system. See section 2.2.
- 5.5 Replacement Intervals: Hose assemblies and elastomeric seals used on Hose Fittings and adapters will eventually age, harden, wear and deteriorate under thermal cycling and compression set. Hose Assemblies and elastomeric seals should be inspected and replaced at specific replacement intervals, based on previous service life, government or industry recommendations, or when failures could result in unacceptable downtime, damage, or injury risk. See section 1.2. Hose and Fittings may be subjected to internal mechanical and/or chemical wear from the conveying fluid and may fail without warning. The user must determine the product life under such circumstances by testing. Also see section 2.5.
- 5.6 Hose Inspection and Failure: Hydraulic power is accomplished by utilizing high pressure fluids to transfer energy and do work. Hoses, Fittings and Hose Assemblies all contribute to this by transmitting fluids at high pressures. Fluids under pressure can be dangerous and potentially lethal and, therefore, extreme caution must be exercised when working with fluids under pressure and handling the Hoses transporting the fluids. From time to time, Hose Assemblies will fail if they are not replaced at proper time intervals. Usually these failures are the result of some form of misapplication, abuse, wear or failure to perform proper maintenance. When Hoses fail, generally the high pressure fluids inside escape in a stream which may or may not be visible to the user. Under no circumstances should the user attempt to locate the leak by "feeling" with their hands or any other part of their body. High pressure fluids can and will penetrate the skin and cause severe tissue damage and possibly loss of limb. Even seemingly minor hydraulic fluid injection injuries must be treated immediately by a physician with knowledge of the tissue damaging properties of hydraulic fluid. If a Hose failure occurs, immediately shut down the equipment and leave the area until pressure has been completely released from the Hose Assembly. Simply shutting down the hydraulic pump may or may not eliminate the pressure in the Hose

Assembly. Many times check valves, etc., are employed in a system and can cause pressure to remain in a Hose Assembly even when pumps or equipment are not operating. Tiny holes in the Hose, commonly known as pinholes, can eject small, dangerously powerful but hard to see streams of hydraulic fluid. It may take several minutes or even hours for the pressure to be relieve so that the Hose Assembly may be examined safely. Once the pressure has been reduced to zero, the Hose Assembly may be taken off the equipment and examined. It must always be replaced if a failure has occurred. Never attempt to patch or repair a Hose Assembly that has failed. Consult the nearest Parker distributor or the appropriate Parker division for Hose Assembly replacement information. Never touch or examine a failed Hose Assembly unless it is obvious that the Hose no longer contains fluid under pressure. The high pressure fluid is extremely dangerous and can cause serious and potentially fatal injury.

- 5.7 Elastomeric seals: Elastomeric seals will eventually age, harden, wear and deteriorate under thermal cycling and compression set. Elastomeric seals should be inspected and replaced.
- 5.8 Refrigerant gases: Special care should be taken when working with refrigeration systems. Sudden escape of refrigerant gases can cause blindness if the escaping gases contact the eye and can cause freezing or other severe injuries if it contacts any other portion of the body.
- 5.9 Compressed natural gas (CNG): Parker CNG Hose Assemblies should be tested after installation and before use, and at least on a monthly basis per instructions provided on the Hose Assembly tag. The recommended procedure is to pressurize the Hose and check for leaks and to visually inspect the Hose for damage and to perform an electrical resistance test. Caution: Matches, candles, open flame or other sources of ignition shall not be used for Hose inspection. Leak check solutions should be rinsed off after use.

6.0 HOSE STORAGE

- 6.1 Age Control: Hose and Hose Assemblies must be stored in a manner that facilitates age control and first-in and first-out usage based on manufacturing date of the Hose and Hose Assemblies. Unless otherwise specified by the manufacturer or defined by local laws and regulations:
- 6.1.1 The shelf life of rubber hose in bulk form or hose made from two or more materials is 28 quarters (7 years) from the date of manufacture, with an extension of 12 quarters (3 years), if stored in accordance with ISO 2230;
- 6.1.2 The shelf life of thermoplastic and polytetrafluoroethylene hose is considered to be unlimited;
- 6.1.3 Hose assemblies that pass visual inspection and proof test shall not be stored for longer than 2 years.
- 6.1.4 Storage: Stored Hose and Hose Assemblies must not be subjected to damage that could reduce their expected service life and must be placed in a cool, dark and dry area with the ends capped. Stored Hose and Hose Assemblies must not be exposed to temperature extremes, ozone, oils, corrosive liquids or fumes, solvents, high humidity, rodents, insects, ultraviolet light, electromagnetic fields, or radioactive materials.

Parker Worldwide

Europe, Middle East, Africa

AE – United Arab Emirates,
Dubai

Tel: +971 4 8127100
parker.me@parker.com

AT – Austria, St. Florian
Tel: +43 (0)7224 66201
parker.austria@parker.com

AZ – Azerbaijan, Baku
Tel: +994 50 2233 458
parker.azerbaijan@parker.com

BE/NL/LU – Benelux,
Hendrik Ido Ambacht
Tel: +31 (0)541 585 000
parker.nl@parker.com

BG – Bulgaria, Sofia
Tel: +359 2 980 1344
parker.bulgaria@parker.com

BY – Belarus, Minsk
Tel: +48 (0)22 573 24 00
parker.poland@parker.com

CH – Switzerland, Etoy
Tel: +41 (0)21 821 87 00
parker.switzerland@parker.com

CZ – Czech Republic, Klecany
Tel: +420 284 083 111
parker.czechrepublic@parker.com

DE – Germany, Kaarst
Tel: +49 (0)2131 4016 0
parker.germany@parker.com

DK – Denmark, Ballerup
Tel: +45 43 56 04 00
parker.denmark@parker.com

ES – Spain, Madrid
Tel: +34 902 330 001
parker.spain@parker.com

FI – Finland, Vantaa
Tel: +358 (0)20 753 2500
parker.finland@parker.com

FR – France, Contamine s/Arve
Tel: +33 (0)4 50 25 80 25
parker.france@parker.com

GR – Greece, Piraeus
Tel: +30 210 933 6450
parker.greece@parker.com

HU – Hungary, Budaörs
Tel: +36 23 885 470
parker.hungary@parker.com

IE – Ireland, Dublin
Tel: +353 (0)1 466 6370
parker.ireland@parker.com

IL – Israel
Tel: +39 02 45 19 21
parker.israel@parker.com

IT – Italy, Corsico (MI)
Tel: +39 02 45 19 21
parker.italy@parker.com

KZ – Kazakhstan, Almaty
Tel: +7 7273 561 000
parker.easteurope@parker.com

NO – Norway, Asker
Tel: +47 66 75 34 00
parker.norway@parker.com

PL – Poland, Warsaw
Tel: +48 (0)22 573 24 00
parker.poland@parker.com

PT – Portugal
Tel: +351 22 999 7360
parker.portugal@parker.com

RO – Romania, Bucharest
Tel: +40 21 252 1382
parker.romania@parker.com

RU – Russia, Moscow
Tel: +7 495 645-2156
parker.russia@parker.com

SE – Sweden, Borås
Tel: +46 (0)8 59 79 50 00
parker.sweden@parker.com

SK – Slovakia, Banská Bystrica
Tel: +421 484 162 252
parker.slovakia@parker.com

SL – Slovenia, Novo Mesto
Tel: +386 7 337 6650
parker.slovenia@parker.com

TR – Turkey, Istanbul
Tel: +90 216 4997081
parker.turkey@parker.com

UA – Ukraine, Kiev
Tel: +48 (0)22 573 24 00
parker.poland@parker.com

UK – United Kingdom, Warwick
Tel: +44 (0)1926 317 878
parker.uk@parker.com

ZA – South Africa, Kempton Park
Tel: +27 (0)11 961 0700
parker.southafrica@parker.com

North America

CA – Canada, Milton, Ontario
Tel: +1 905 693 3000

US – USA, Cleveland
Tel: +1 216 896 3000

Asia Pacific

AU – Australia, Castle Hill
Tel: +61 (0)2-9634 7777

CN – China, Shanghai
Tel: +86 21 2899 5000

HK – Hong Kong
Tel: +852 2428 8008

IN – India, Gurgaon
Tel: +91 124 459 0600
legris.india@parker.com

JP – Japan, Tokyo
Tel: +81 (0)3 6408 3901

KR – South Korea, Seoul
Tel: +82 2 559 0400

MY – Malaysia, Shah Alam
Tel: +60 3 7849 0800

NZ – New Zealand, Mt Wellington
Tel: +64 9 574 1744

SG – Singapore
Tel: +65 6887 6300

TH – Thailand, Bangkok
Tel: +662 186 7000

TW – Taiwan, Taipei
Tel: +886 2 2298 8987

South America

AR – Argentina, Buenos Aires
Tel: +54 3327 44 4129

BR – Brazil, Sao Jose dos Campos
Tel: +55 800 727 5374

CL – Chile, Santiago
Tel: +56 2 623 1216

MX – Mexico, Toluca
Tel: +52 72 2275 4200

European Product Information Centre
Free phone: 00 800 27 27 5374
(from AT, BE, CH, CZ, DE, DK, EE, ES, FI,
FR, IE, IL, IS, IT, LU, MT, NL, NO, PL, PT, RU,
SE, SK, UK, ZA)

Ed. 01-2020



Low Pressure Connectors Division Europe Parker Hannifin Manufacturing France SAS

Distribution Industrial & Processing Business Unit
Parc Alcyone - Bâtiment D
1, rue André et Yvonne Meynier
35069 Rennes Cedex - France
phone : + 33 (0)2 99 25 55 00
www.parker.com/lpce www.parkerlegris.com